

Assembly Instructions optoCONTROL 2520-46(090)

Proper Environment

- Protection class: IP64; when plugged in or with protective cap on Ethernet socket¹
- Temperature range:
 - Operation: 0 ... +50 °C (+32 ... +122 °F)
 - Storage: -20 ... +70 °C (-4 ... +158 °F)
- Humidity: 5 ... 95% RH (non-condensing)
- Ambient pressure: Atmospheric pressure

¹ The protection class is limited to water (no penetrating liquids, detergents or similarly aggressive media). Use a protective housing if there is constant exposure to water.

Optical windows are excluded from the protection class. Contamination of the windows causes impairment or failure of the function.

1) For operation without Ethernet / EtherCAT cable, the protective cap for the M12 connector must be plugged to achieve the IP degree of protection!

Warnings

Connect the power supply according to the safety regulations for electrical equipment. The supply voltage must not exceed the specified limits.

> Risk of injury, damage to or destruction of the system.

Protect the cable against damage. Never bend the cable more tightly than the bending radius.

> Failure of the measuring device, damage to and destruction of the cable.

Avoid shocks and impacts to the light source and receiver.

> Damage to or destruction of the system

Laser Safety

The optoCONTROL 2520-46(090) operates with a semiconductor laser with a wavelength of 670 nm (visible/red). The maximum optical power is 2 mW. The sensors fall within laser class 1M. The following warning labels must be attached to the cover (front and/or rear side) of the sensor housing. The laser warning labels for Germany have already been attached. For other non German speaking countries, an IEC standard label is included in delivery and the versions valid for the user's country must be attached before the device is put into operation for the first time.

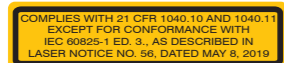

Only for USA

The accessible radiation is harmless under predictable conditions. Do not view the radiation with optical instruments (e.g., converging lenses, magnifying glasses). For class 1M laser devices, impairment of color vision and disturbances, e.g., from a glare effect, cannot be excluded. Consequently, you can use Class 1M laser equipment without further protective measures. Lasers of Class 1M are not subject to notification and a laser protection officer is not required.



Dimensional Drawings

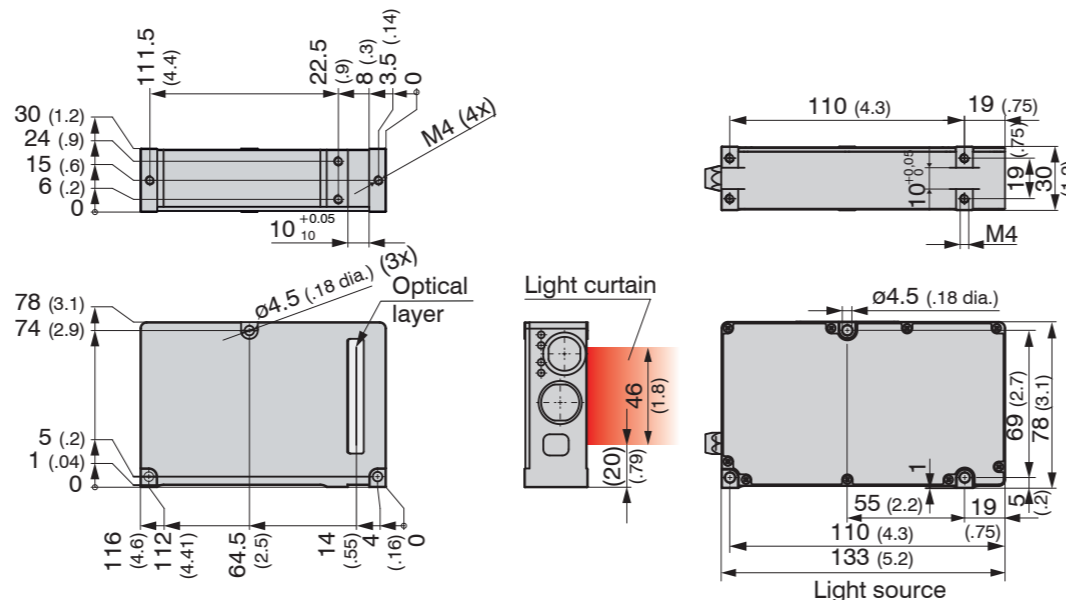

Fig. 1 Dimensional drawing of light source and receiver, dimensions in mm (inches, rounded off)

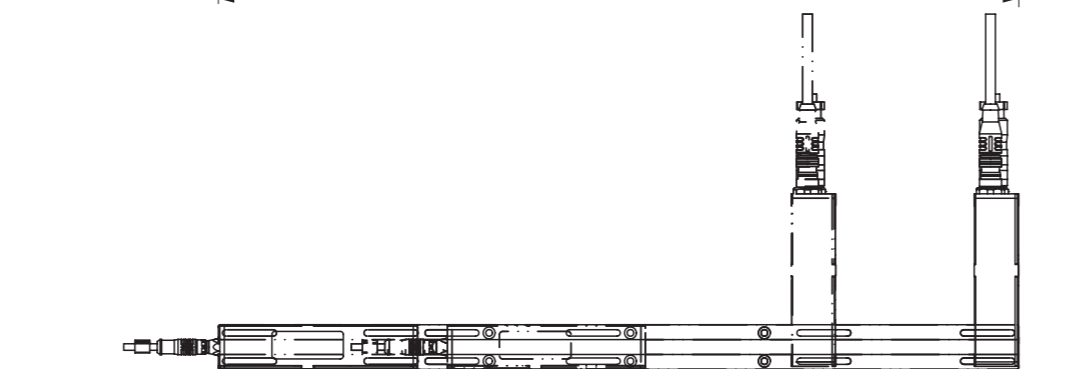
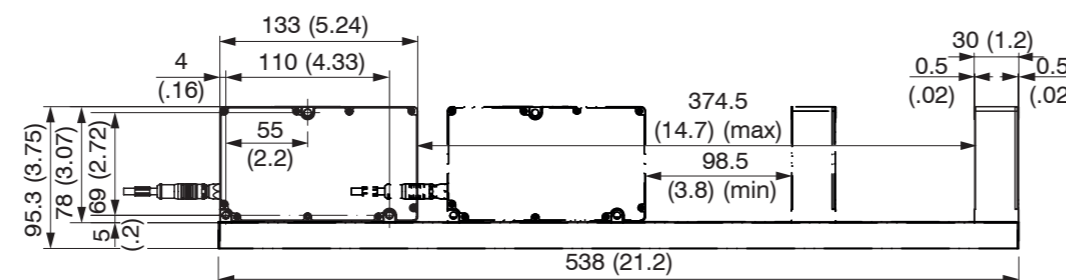

Fig. 2 Dimensional drawing of light source and receiver with mounting rail, dimensions in mm (inches, rounded off)

MICRO-EPSILON Eltrotec GmbH
Manfred-Wörner-Straße 101
73037 Göppingen / Germany

eltrotec@micro-epsilon.com
www.micro-epsilon.com
Your local contact: www.micro-epsilon.com/contact/worldwide/

X9771306.03-A022123HDR



Supply Voltage (Power)

Signal	Description	Notes	Color on PC/SC2520-x	Pin
+24 V DC	Supply voltage	11 to 30 VDC, $I_{max} < 200 \text{ mA}$ at 24 VDC ³	red	E
GND	Supply voltage ground	Reference ground for Power, Out, In, Sync, RS422	black	R
Out 1	Switching output 1	Errors or limits, not electrically separated, 24V logic (HTL), $I_{max} = 0.1 \text{ A}$, $U_{max} = 30 \text{ V}$ Saturation voltage at $I_{max} = 0.1 \text{ A}$: Low < 2.5 V (output - GND), High < 2.5 V (output - supply voltage)	blue	P
Out 2	Switching output 2		pink	O
In	Zeroing/mastering or re-setting to factory defaults	Not electrically separated, 24V logic (HTL), Low level $\leq 3 \text{ V}$, High level $\geq 10 \text{ V}$ (max 30 V), Internal pull-up resistor, open input is detected as High.	gray/pink	T
Sync In/out	Synchronization or triggering, synchronous output	Symmetrical, RS422 level, terminating resistor (120 Ohm) and direction can be switched using software, not electrically separated	white/green	U
/Sync In/out			red/blue	L
RX - 422	RS422	Interface RS422, symmetrical, RX internally terminated with 100 Ohm, max. 4 MBaud, full duplex, not electrically separated	brown	M
/RX - 422			green	A
/TX - 422			yellow	N
TX - 422			gray	C
GND-RS422		Equipotential bonding RS422/Sync, if there is no other galvanic connection.	purple	J
Analog Out	Voltage output	0 ... 10 V not electrically separated, 14 Bit D/A, R_i approx. 50 Ohm, Load: $C_i < 22 \text{ nF}$, $R_a > 10 \text{ kOhm}$	white ¹	S
Analog GND	Ground analog output	Reference ground for voltage output	Inner shield ¹	G
PE	Entire outer shield	Connect to PE of system	black ²	Housing

Fig. 4 Pin assignments for 14-pin round plug (power/signals)

A cable with open ends (PC/SC2520-x) is required and is available as an optional accessory.

▶ Connect at least the power supply and turn it on.

▶ If installed freestanding, now adjust the alignment between light source and receiver.

¹ The laser light must hit the receiver's inlet window exactly in the center. The following applies here:
² The greater the distance between light source and receiver, the more exact an alignment is required!

1) Internal coaxial cable for voltage output in PC/SC2520-3

2) Shrinking hose with wire end

3) With open switching outputs

Light Source Socket (3-Pin)

Cables of different lengths (1 m, 2 m or 5 m, each optionally with straight or angled plugs) are available as accessories to connect the light source to the receiver.

Ethernet/EtherCAT Socket (4-Pin)

Electrically isolated M12x1 socket to connect to an Ethernet network (PC) or the EtherCAT bus system. Ethernet cables with straight and angled plugs to RJ45 plugs are available as accessories. The receiver is connected to a PC or generally to a network via the Ethernet interface. A web browser is used to call up the receiver's internal web pages and set up the measuring system there.

Pin	Signal
1	TX+
2	RX+
3	TX-
4	RX-

4-pin built-in socket, view of connector side or 4-pin cable plug, view of solder side

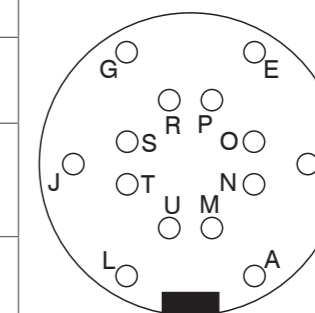

14-pin cable connector

View on solder side



Fig. 3 14-pin cable socket for supply and signals



Fig. 6 Ethernet/EtherCAT socket

LEDs on Receiver

LED	Color	Meaning
Power on	Green	Operating voltage on
Status	Yellow	If synchronization error
	Flashing red	Ethernet, error
	Yellow	Loading factory settings
	Green	Zeroing/mastering
If the EtherCAT interface is enabled, the meaning complies with the EtherCAT guidelines.		
Speed	Yellow	If baud rate 100 Mb
	Off	If baud rate 10 Mb
Link/activity	Green	If link active
	Off	If link inactive
	Flashing	If network activity

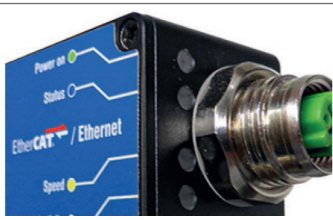

Fig. 7 LEDs on the Ethernet/ EtherCAT socket

Structure of the Components

- Light source
 - Receiver
- on the supplied mounting rail (or freestanding mounting on your own sturdy device)
- Power supply
 - Laptop/PC
- A cable with open ends (PC/SC2520-x) is required and is available as an optional accessory, see also operating instructions, Chapter "Optional Accessories".
- Position the light source and receiver so that the connections and displays are not concealed. Never bend the cable more tightly than the bending radius. Light source and receiver must be located on the same plane and must not be tilted in relation to each other!

Only attach the light source and receiver using the existing holes on a flat surface. Any type of clamping is not permitted.
 > Inaccurate or incorrect measurements

Light source and receiver can be attached using the three through-holes \varnothing 4.5 mm each (bolt connection) or, if the mounting rail is not used, using the four M4 threaded holes in each housing bottom, which ensure a maximum screwing depth of 5 mm (direct screw connection).

If light source and receiver must be installed without the supplied mounting rail, you must make sure that the components are exactly aligned with each other.

➔ After installation of light source and receiver, check and adjust the centered alignment of the light band on the receiver at the correct distance. If necessary, loosen the light source for exact positioning.

• Please observe additional installation notes with and without mounting rail in Chapter 5.2 of the operating instructions.

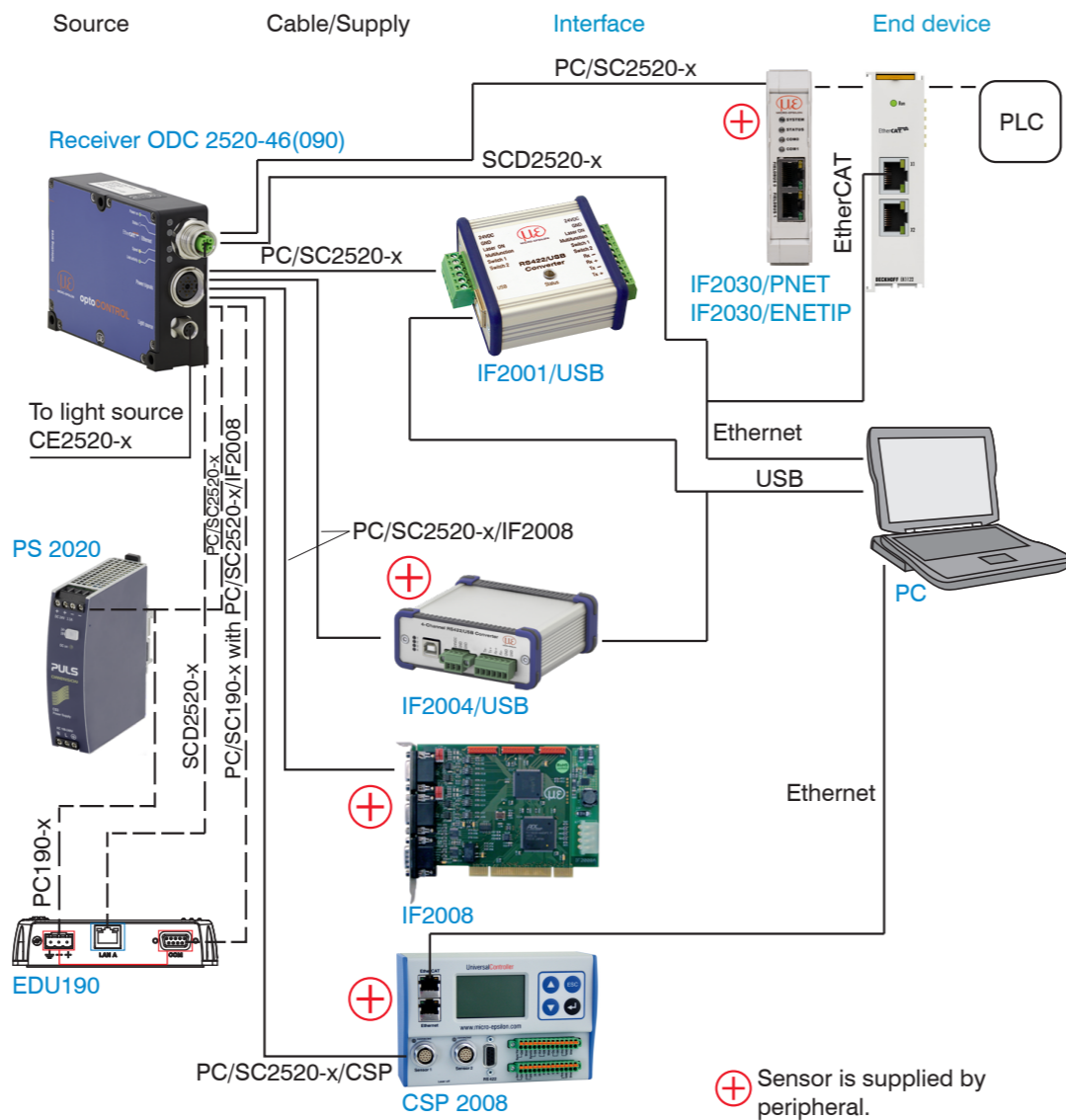

Fig. 8 Connection examples on the optoCONTROL 2520-46(090)

Using the 14-pin socket Power/signals, various peripherals¹⁾ can be connected with the connecting cables shown¹⁾.

1) The various peripherals and connecting cables are available as optional accessories, see also operating instructions, Chapter "Optional Accessories".

Quick Guide

The measuring system is shipped with the factory-set IP address 169.254.168.150.

You can query the IP addresses of the sensors that are connected to a PC or network by using the sensorTOOL program.

➔ Start the sensorTOOL program and click the **Sensor** button.

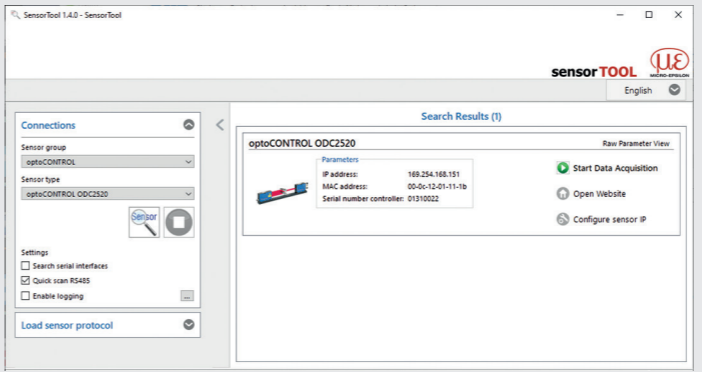

➔ Select the correct sensor from the list.
 ➔ Click the **Open Website** button to connect the sensor to your default browser.

The sensorTOOL program is available online at <https://www.micro-epsilon.com/service/download/software>.

The start screen of the sensor software should now be displayed in the web browser.

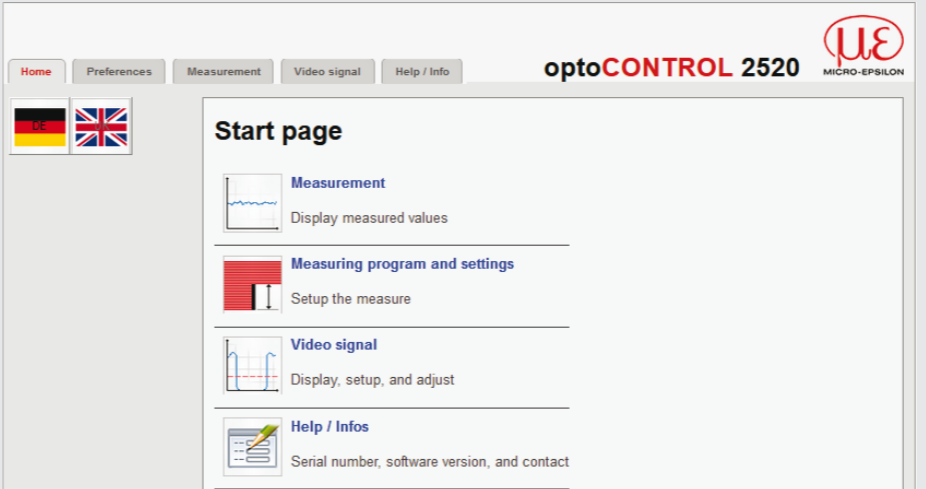

Access features (e.g. Settings, Video signal, etc.) are available in the top navigation bar. All settings on the web page are implemented in the sensor immediately after clicking the **Apply** button. Parallel operation with web browser and ASCII commands is possible; the last setting applies.

• Don't forget to save!

You can download a PDF of detailed operating instructions from our website: <http://www.micro-epsilon.de/download/manuals/man--optoCONTROL-2520--en.pdf>



Selecting Measuring Distance

- ➔ Go to the **Settings > Measuring distance** menu.
- ➔ Select a calibrated measuring distance from the list, confirm with **Apply**.
- If the measuring distance changes during the measurement or the edge to be measured is very thick in parallel to the laser beam, a relatively large linearity error may occur.

Selecting Measuring Program

- ➔ Go to the **Settings > Measuring program > Measurement to be performed** menu.
- ➔ Select, e.g., **Edge light-dark** as the measurement to be performed.

Performing Light Referencing

- This referencing must be performed at least once after installation and a warm-up period of about 30 min., but can also be repeated very frequently if great accuracy is required.
- When performing a light referencing using the menu **Video signal > Light referencing > Start light referencing** button.
 - ➔ Press **Stop** once and **Start** once, if the diagram does not restart automatically.

Positioning the Target

- ➔ Position the measured object at the selected measuring distance to the receiver, as much as possible in the center of the measuring range.
- If the edge to be measured is very thick, it must be aligned exactly parallel to the laser beam.

Checking the Video Signal

- ➔ Go to the **Video signal** menu and check the signal.
- The edges to be measured must intersect the detection threshold. If a transparent measured object is to be measured, you can increase the detection threshold, if necessary. However, this can affect linearity.

Checking the Measurement

- ➔ Go to the **Measurement** menu and check the measured value-time diagram.
- You can select additional data for display, e.g., individual edges or center axes, in the measuring programs **Diameter**, **Gap** and **Segment**.

This page also allows you to quickly change notification settings and watch their effect.

Saving the Settings

- ➔ Save the current settings in the receiver using a **setup**.
- Otherwise, the settings will be lost when the receiver is turned off.