



Operating Instructions
confocalDT IFD2410/2411/2415

IFD2410-1
IFD2410-3
IFD2410-6

IFD2411-1
IFD2411-2
IFD2411/90-2
IFD2411-3
IFD2411-6

IFD2415-1
IFD2415-3
IFD2415-10

Confocal chromatic distance and thickness measurement

MICRO-EPSILON
MESSTECHNIK
GmbH & Co. KG
Koenigbacher Str. 15

94496 Ortenburg/Germany

Tel. +49 (0) 8542 / 168-0
Fax +49 (0) 8542 / 168-90
e-mail info@micro-epsilon.com
www.micro-epsilon.com

confocalDT 2410

confocalDT 2411

confocalDT 2415



EtherCAT® is registered trademark and patented technology, licensed by Beckhoff Automation GmbH, Germany.

Contents

1.	Safety	9
1.1	Symbols Used	9
1.2	Warnings	9
1.3	Notes on Product Marking	10
1.3.1	Notes on CE Marking	10
1.3.2	Notes on UKCA Marking	10
1.4	Intended Use	10
1.5	Proper Environment	10
2.	Functional Principle, Technical Data	11
2.1	Short Description	11
2.2	Measuring Principle	11
2.3	Term Definitions, Glossary	12
2.4	Technical Data for confocalDT IFD2410/2415	13
2.5	Technical Data confocalDT IFD2411	14
3.	Delivery	15
3.1	Scope of Delivery confocalDT IFD2410/2415	15
3.2	Scope of Delivery confocalDT IFD2411	15
3.3	Storage	15
4.	Mounting	16
4.1	Preliminary Remarks	16
4.2	confocalDT IFD2410/2415	16
4.2.1	Circumferential Clamping	16
4.2.2	Direct Screw Connection	17
4.2.3	Electrical Connections, Pin Assignment	18
4.2.4	Grounding Concept, Shielding	19
4.2.5	Supply Voltage (Power)	19
4.2.6	RS422	20
4.2.7	Ethernet, EtherCAT	20
4.2.8	Analog Output	21
4.2.9	Multifunction inputs	21
4.2.10	Switching Outputs (digital I/O)	22
4.2.11	Synchronization (Inputs/Outputs)	23
4.2.11.1	General	23
4.2.11.2	Internal Synchronization	23
4.2.11.3	External Synchronization	24
4.2.12	Triggering	25
4.2.12.1	General	25
4.2.12.2	Triggering with Multifunction Input	25
4.2.12.3	Triggering with Synchronization Input	25
4.2.12.4	Triggering with Input Encoder 1	25
4.2.13	Encoder Inputs	26
4.3	confocalDT 2411	27
4.3.1	IFC2411 Controller	27
4.3.2	Sensor Cable, Optical Fiber	27
4.3.3	Dimensional Drawing of Sensors	29
4.3.4	Fastening, Mounting Adapter	29
4.3.4.1	General	29
4.3.4.2	Circumferential Clamping	29
4.3.5	Electrical Connections, Pin Assignment	31
4.3.6	Grounding Concept, Shielding	31
4.3.7	Supply Voltage (Power)	32
4.3.8	RS422	32
4.3.9	Ethernet, EtherCAT	32
4.3.10	Analog Output	33
4.3.11	Multifunction Input	33
4.3.12	Synchronization (Inputs/Outputs)	34
4.3.12.1	General	34
4.3.12.2	Internal Synchronization	34
4.3.12.3	External Synchronization Controller	35
4.3.13	Triggering	36
4.3.13.1	General	36
4.3.13.2	Triggering with Multifunction Input	36
4.3.13.3	Triggering with Synchronization Input	36
4.3.13.4	Triggering with Input Encoder 1	37
4.3.14	Encoder Input	37
4.3.15	Handling of the Plug-In Screw Terminals	37
4.3.16	Dark Correction IFD2415	37
4.4	LEDs	38
4.5	Correct and Multifunction Key	38
5.	Commissioning	39
5.1	Communication Options	39
5.2	Access via Web Interface	40
5.3	Positioning the Target	41
5.4	Select Sensor	41
5.5	Presets, Setups, Measurement Configuration Selection	42
5.6	Video Signal	43

5.7	Signal Quality	44
5.8	Distance Measurement with Website Display	45
5.9	Save/Load Settings.....	47
5.10	Dark Correction.....	49
6.	Set Sensor Parameters, Web Interface	51
6.1	Inputs	51
6.1.1	Synchronization	51
6.1.2	Encoder Inputs	51
6.1.2.1	Overview, Menu.....	51
6.1.2.2	Number of Encoders.....	51
6.1.2.3	Interpolation	52
6.1.2.4	Maximum Value.....	52
6.1.2.5	Effect of Reference Track.....	52
6.1.2.6	Set to Value	52
6.1.2.7	Reset Reference Marker	52
6.1.3	Level Function Inputs	53
6.1.4	Terminating Resistor	53
6.2	Data Recording.....	54
6.2.1	Measuring Rate	54
6.2.2	Triggering Data Acquisition	55
6.2.2.1	General.....	55
6.2.2.2	Triggering Measured Value Acquisition	55
6.2.2.3	Trigger Time Difference.....	56
6.2.3	Reset Counter.....	56
6.2.4	Range of Interest Masking	56
6.2.5	Exposure Mode	57
6.2.6	Peak Separation	58
6.2.6.1	Peak Modulation	58
6.2.6.2	Detection Threshold	58
6.2.7	Number of Peaks, Peak Selection.....	59
6.2.8	Material Selection	60
6.3	Signal Processing, Calculation.....	61
6.3.1	Data Source, Parameters, Calculation Programs	61
6.3.2	Definitions	62
6.3.3	Measurement Averaging	63
6.4	Post-Processing.....	66
6.4.1	Zeroing, Mastering	66
6.4.2	Statistics	68
6.4.3	Data Reduction, Output Data Rate.....	69
6.4.4	Error Handling (Hold Last Value)	69
6.5	Outputs	70
6.5.1	Interface RS422	70
6.5.2	Ethernet Setup Mode	70
6.5.3	RS422	70
6.5.4	Analog Output	71
6.5.4.1	Calculating Measured Value from Current Output	71
6.5.4.2	Calculation measured value from Voltage Output	72
6.5.5	Data Output	72
6.6	System Settings.....	73
6.6.1	Web Interface Unit	73
6.6.2	Key Lock	73
6.6.3	Loading and Saving	73
6.6.4	Access Authorization.....	73
6.6.5	Reset System.....	74
6.6.6	Light Source	74
6.6.7	Boot Mode	74
7.	Thickness Measurement, One-Sided, Transparent Target	75
7.1	Requirement	75
7.2	Preset.....	75
7.3	Material Selection	75
7.4	Video Signal.....	76
7.5	Signal Processing.....	76
7.6	Measurement Chart	77
8.	EtherCAT Documentation	78
8.1	General	78
8.2	Introduction.....	78
8.2.1	Structure of EtherCAT® Frames	78
8.2.2	EtherCAT® Services.....	78
8.2.3	Addressing and FMMUs.....	79
8.2.4	Sync Manager	79
8.2.5	EtherCAT State Machine	79
8.2.6	CANopen over EtherCAT.....	80
8.2.7	Process Data PDO Mapping	80
8.2.8	Service Data SDO Service.....	80
8.3	CoE – Object Directory.....	81
8.3.1	Communication Specific Standard Objects.....	81
8.3.1.1	Overview	81
8.3.1.2	Object 1001h: Device Type.....	81
8.3.1.3	Object 1008h: Manufacturer Device Name	81
8.3.1.4	Object 1009h: Hardware Version.....	81
8.3.1.5	Object 100Ah: Software Version.....	81

8.3.1.6	Object 1018h: Device Identification.....	81
8.3.1.7	TxPDO Mapping IFD2410, 2411.....	82
8.3.1.8	TxPDO Mapping IFD2415.....	91
8.3.1.9	Example of TxPDO Mapping.....	104
8.3.1.10	Object 1C00h: Synchronous Manager Type.....	105
8.3.1.11	Object 1C12h: RxPDO Assign.....	105
8.3.1.12	Object 1C13h: TxPDO Assign.....	105
8.3.1.13	Object 1C32h: Sync Manager Output Parameters.....	106
8.3.1.14	Object 1C33h: Sync Manager Input Parameters.....	106
8.3.2	Manufacturer Specific Objects.....	107
8.3.2.1	Overview.....	107
8.3.2.2	Object 3001h: User Level.....	108
8.3.2.3	Object 3005h: Information on the IFD241x (further).....	108
8.3.2.4	Object 3011h: Correction, Channel 1.....	108
8.3.2.5	Object 3020h: Load, Save, Factory Setting.....	109
8.3.2.6	Object 3021h: Preset.....	109
8.3.2.7	Object 3022h: Measurement Settings.....	109
8.3.2.8	Object 303Fh: Error IFD241x.....	110
8.3.2.9	Object 3101h: Reset.....	110
8.3.2.10	Object 3105h: Factory Settings.....	110
8.3.2.11	Object 3107h: Reset Counter.....	110
8.3.2.12	Object 3133h: LED Light Source Channel 1.....	110
8.3.2.13	Object 3150h: Error IFD241x Channel 1.....	110
8.3.2.14	Object 3152h: Sensor Selection Channel 1.....	111
8.3.2.15	Object 3153h: Sensor Table.....	111
8.3.2.16	Object 3156h: Multilayer Options for Channel 1.....	111
8.3.2.17	Object 3161h: Peak Selection Channel 1.....	111
8.3.2.18	Object 3162h: Peak Options Channel 1.....	112
8.3.2.19	Object 31B0h: Digital Interfaces.....	112
8.3.2.20	Object 31B1h: Interface Selection.....	112
8.3.2.21	Object 31B2h: Error Handling.....	112
8.3.2.22	Object 31B3h: Data Reduction.....	112
8.3.2.23	Object 31D0h: Analog Output.....	113
8.3.2.24	Object 31F3h: Switching Output 1.....	114
8.3.2.25	Object 31F5h: RS422 Output.....	115
8.3.2.26	Object 3250h: Exposure Mode Channel 1.....	115
8.3.2.27	Object 3251h: Measuring Rate.....	115
8.3.2.28	Object 34A0h: Keylock.....	115
8.3.2.29	Object 35A0h: Encoder.....	116
8.3.2.30	Object 35B0 Triggering.....	116
8.3.2.31	Object 35B1 Synchronization.....	117
8.3.2.32	Object 3711h: Range of Interest Masking Channel 1.....	117
8.3.2.33	Object 3800h: Material Information.....	117
8.3.2.34	Object 3802h: Edit Material Table.....	118
8.3.2.35	Object 3803h: Existing Materials.....	118
8.3.2.36	Object 3804h: Select Material for Channel 1.....	118
8.3.2.37	Object 3A00h: Mastering, Zeroing.....	118
8.3.2.38	Object 3A10h: Statistics.....	119
8.3.2.39	Object 3C00h: Measured Value Calculation Channel 1.....	120
8.3.2.40	Object 3CBFh: Sys Signals.....	121
8.3.2.41	Object 3E00: User Signals.....	121
8.4	Mappable Objects – Process Data.....	122
8.4.1	Object 6000, 6001: Distance Value.....	122
8.4.2	Object 6010, 6011: Intensity.....	122
8.4.3	Object 6030: Exposure Time.....	123
8.4.4	Object 6050, 6051, 6052: Encoder.....	123
8.4.5	Object 6060: Peak Symmetry.....	123
8.4.6	Object 7000: Measured Value Counter.....	124
8.4.7	Object 7001: Timestamp.....	124
8.4.8	Object 7002: Measuring Rate.....	124
8.4.9	Object 7C00: Calculated Process Data.....	125
8.5	Error Codes for SDO Services.....	125
8.6	Oversampling.....	126
8.7	Calculation.....	128
8.7.1	Setting a Filter.....	128
8.7.2	Thickness Calculation.....	128
8.8	Operational Modes.....	129
8.8.1	Free Run.....	129
8.8.2	Distributed Clocks SYNC0 Synchronization.....	129
8.8.3	SM2/SM3 Synchronization.....	129
8.9	Update.....	129
8.9.1	Update via FoE.....	129
8.9.2	Update via EoE.....	129
8.10	Meaning of LEDs in EtherCAT Operation.....	130
8.11	EtherCAT Configuration with the Beckhoff TwinCAT® Manager.....	131
9.	Error, Repair.....	133
9.1	Web Interface Communication.....	133
9.2	Changing the Sensor Cable on the Sensors.....	133
9.3	Replacing the Protective Glass on the Sensors.....	133
10.	Software Support with MEDAQLib.....	134
11.	Disclaimer.....	134

12.	Service, Repair	135
13.	Decommissioning, Disposal	136
	Appendix.....	137
A 1	Optional accessories, services	137
A 1.1	Optional accessories confocalDT IFD2410/2415.....	137
A 1.2	Optional Accessories confocalDT IFD2411	137
A 1.3	Services	137
A 2	Factory Settings	138
A 2.1	confocalDT IFD2410/2415.....	138
A 2.2	confocalDT IFD2411	138
A 3	Adjustable Mounting Adapter JMA-xx.....	139
A 3.1	Functions	139
A 3.2	Sensor Mounting, Compatibility	139
A 3.3	Mounting.....	139
A 3.4	Dimensional Drawing of Mounting Adapter	139
A 3.5	Perpendicular Alignment of Sensor.....	140
A 4	Cleaning Optical Components	141
A 4.1	Contamination	141
A 4.2	Tools and Cleaning Agents	142
A 4.3	Sensor Protective Glass	142
A 4.4	Interface between Controller and Sensor Cable.....	143
A 4.5	Interface between Sensor Cable and Sensor	144
A 4.6	Preventive Protection.....	144
A 5	ASCII Communication with Controller	145
A 5.1	General	145
A 5.2	Commands Overview	145
A 5.3	General Commands	148
A 5.3.1	General	148
A 5.3.1.1	Help	148
A 5.3.1.2	Controller Information.....	148
A 5.3.1.3	Reply type.....	148
A 5.3.1.4	Parameter Overview	148
A 5.3.1.5	Synchronization	149
A 5.3.1.6	Termination Resistor at Sync/Trig.....	149
A 5.3.1.7	Boot Sensor	149
A 5.3.1.8	Reset Counter	149
A 5.3.2	User level.....	150
A 5.3.2.1	Change User Level	150
A 5.3.2.2	Switch to User Level	150
A 5.3.2.3	User Level Query	150
A 5.3.2.4	Set Standard User	150
A 5.3.2.5	Change Password	150
A 5.3.3	Level of Multifunction Inputs.....	150
A 5.3.4	Sensor	151
A 5.3.4.1	Information on Calibration Tables.....	151
A 5.3.4.2	Sensor Information	151
A 5.3.4.3	Dark Correction.....	151
A 5.3.4.4	LED.....	151
A 5.3.4.5	Control Input Measurement Light Source	151
A 5.3.5	Triggering.....	152
A 5.3.5.1	Select Trigger Source	152
A 5.3.5.2	Output of Triggered Values, with/without Averaging.....	152
A 5.3.5.3	Trigger Type	152
A 5.3.5.4	Active Level of Trigger Input	152
A 5.3.5.5	Software Trigger Pulse.....	152
A 5.3.5.6	Number of Measured Values to be Output.....	152
A 5.3.5.7	Level Section Trigger Input TrigIn.....	153
A 5.3.5.8	Step Size Encoder Triggering.....	153
A 5.3.5.9	Minimum Encoder Triggering	153
A 5.3.5.10	Maximum Encoder Triggering	153
A 5.3.6	Encoder	153
A 5.3.6.1	Number of Available Encoders	153
A 5.3.6.2	Encoder Interpolation Depth	153
A 5.3.6.3	Effect of Reference Track.....	153
A 5.3.6.4	Encoder value.....	154
A 5.3.6.5	Set Encoder Value via Software	154
A 5.3.6.6	Reset Detection of First Reference Marker.....	154
A 5.3.6.7	Maximum Encoder Value.....	154
A 5.3.6.8	Number of Active Encoders.....	154
A 5.3.7	Setting the RS422 Baud Rate.....	155
A 5.3.8	Parameter Management, Load/Save Settings	156
A 5.3.8.1	Load / Save Connection Settings.....	156
A 5.3.8.2	Show Changed Parameters.....	156
A 5.3.8.3	Export Parameter Sets to PC.....	156
A 5.3.8.4	Import Parameter Sets from PC.....	156
A 5.3.8.5	Factory Settings	156
A 5.3.8.6	Editing, Storing, Displaying, Deleting Measurement Settings	157

A 5.3.9	Measurement.....	157
	A 5.3.9.1 Peak count	157
	A 5.3.9.2 Peak Selection	157
	A 5.3.9.3 Number of Peaks and Switching Refractivity Correction On/Off.....	158
	A 5.3.9.4 Exposure Mode.....	158
	A 5.3.9.5 Measuring rate	158
	A 5.3.9.6 Exposure Time	158
	A 5.3.9.7 Range of Interest (ROI)	158
	A 5.3.9.8 Minimum Threshold Peak Detection	158
	A 5.3.9.9 Peak Modulation	159
A 5.3.10	Material Database.....	159
	A 5.3.10.1 Material Table.....	159
	A 5.3.10.2 Select Material.....	159
	A 5.3.10.3 Show Material Property.....	159
	A 5.3.10.4 Existing Material in Controller	159
	A 5.3.10.5 Protected Materials in Controller	159
	A 5.3.10.6 Edit Material Table.....	160
	A 5.3.10.7 Delete a Material	160
	A 5.3.10.8 Add Material	160
A 5.3.11	Edit measured value.....	160
	A 5.3.11.1 Statistical Calculations.....	160
	A 5.3.11.2 List of Statistics Signals	160
	A 5.3.11.3 Selection of Statistics Signal	161
	A 5.3.11.4 List of Possible Statistics Signals to Select	161
	A 5.3.11.5 List of Possible Signals to be Parameterized	161
	A 5.3.11.6 Parameterization of Master Signals.....	161
	A 5.3.11.7 List of Possible Signals for Mastering.....	161
	A 5.3.11.8 Mastering / Zeroing.....	161
	A 5.3.11.9 Signal for Mastering with External Source	162
	A 5.3.11.10 Mastering with External Source.....	162
	A 5.3.11.11 Example of Mastering	162
	A 5.3.11.12 Calculation in channel	164
	A 5.3.11.13 List of Possible Calculation Signals.....	164
	A 5.3.11.14 Two-Point Scaling Data Outputs.....	164
A 5.3.12	Data Output	165
	A 5.3.12.1 Digital Output Selection	165
	A 5.3.12.2 Output Data Rate	165
	A 5.3.12.3 Reduction Counter for Output of measured values	165
	A 5.3.12.4 Error Handling.....	165
A 5.3.13	Selection of Measured Values to be Output	166
	A 5.3.13.1 General.....	166
	A 5.3.13.2 Data Selection for RS422.....	166
	A 5.3.13.3 List of Possible Signals for RS422.....	166
	A 5.3.13.4 List of Selected Signals, Sequence via Rs422	166
A 5.3.14	Switching Outputs	166
	A 5.3.14.1 General.....	166
	A 5.3.14.2 Error - Switching Outputs	166
	A 5.3.14.3 List of Possible Signals for Error Output	166
	A 5.3.14.4 Set Signal to be Evaluated	166
	A 5.3.14.5 Set Limit Values.....	167
	A 5.3.14.6 Set Value	167
	A 5.3.14.7 Switching Behavior of Error Outputs	167
	A 5.3.14.8 Switching Hysteresis of Error Outputs	167
A 5.3.15	Analog Output	167
	A 5.3.15.1 Data Selection.....	167
	A 5.3.15.2 List of Possible Signals for Analog Output.....	167
	A 5.3.15.3 Output Range.....	167
	A 5.3.15.4 Set Scaling for DAC	168
	A 5.3.15.5 Set Scaling Range	168
A 5.3.16	System Settings.....	168
	A 5.3.16.1 Key Lock.....	168
	A 5.3.16.2 Switch EtherCAT to Ethernet Setup Mode	168
A 5.4	Measured Value Format.....	169
	A 5.4.1 Structure	169
	A 5.4.2 Video Signal	169
	A 5.4.3 Exposure Time.....	169
	A 5.4.4 Encoder	169
	A 5.4.5 Measured Value Counter.....	170
	A 5.4.6 Timestamp.....	170
	A 5.4.7 Measuring Data (Distances and Intensities)	170
	A 5.4.8 Trigger Time Difference	170
	A 5.4.9 Differences (thicknesses)	170
	A 5.4.10 Statistical Values.....	170
	A 5.4.11 Peak Symmetry	170
A 5.5	Measuring Data Formats	171
	A 5.5.1 Data Format RS422 Interface	171
	A 5.5.1.1 Video Data.....	171
	A 5.5.1.2 Measured Values	171
A 5.6	Warning and Error Messages.....	173

A 6	Switch between EtherCAT and Ethernet Setup Mode	175
A 7	Switching between Ethernet Setup Mode and EtherCAT	175
A 8	Telnet.....	176
A 8.1	General	176
A 8.2	Establishing the Connection	176
A 8.3	Help on a Command	177
A 8.4	Error Messages.....	177

1. Safety

System operation assumes knowledge of the operating instructions.

1.1 Symbols Used

The following symbols are used in these operating instructions:



Indicates a hazardous situation which, if not avoided, may result in minor or moderate injury.



Indicates a situation that may result in property damage if not avoided.



Indicates a user action.



Indicates a tip for users.

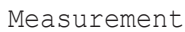

Indicates hardware or a software button/menu.

1.2 Warnings



Connect the power supply and the display/output device according to the safety regulations for electrical equipment.

- > Risk of injury
- > Damage to or destruction of the controller

The surface of the sensors or controller heats up to a temperature of over 50°C when all interfaces are used.

- > Risk of injury



The supply voltage must not exceed the specified limits.

- > Damage to or destruction of the controller

Avoid shocks and impacts to the controller and the sensor.

- > Damage to or destruction of the components

Never fold the optical fiber and do not bend it in tight radii.

- > Damage to or destruction of the optical fiber, failure of measuring device

Protect the ends of the optical fiber against contamination (use protective caps).

- > Incorrect measurement
- > Failure of the measuring device

Protect the cables against damage.

- > Failure of the measuring device

1.3 Notes on Product Marking

1.3.1 Notes on CE Marking

Please note the following for the confocalDT IFD2410/2411/2415 measuring system:

- EU Directive 2014/30/EU
- EU Directive 2011/65/EU

Products which carry the CE mark satisfy the requirements of the EU directives cited and the relevant applicable harmonized European standards (EN). The measuring system is designed for use in industrial and home applications and meets the requirements.

The EU Declaration of Conformity is available to the responsible authorities according to EU Directive, Article 10.

1.3.2 Notes on UKCA Marking

Please note the following for the confocalDT IFD2410/2411/2415 measuring system:

- SI 2016 No. 1091:2016-11-16 The Electromagnetic Compatibility Regulations 2016
- SI 2012 No. 3032:2012-12-07 The Restriction of the Use of Certain Hazardous Substances in Electrical and Electronic Equipment Regulations 2012

Products which bear the CE mark meet the requirements of the EU directives cited and the relevant applicable harmonized European standards. The measuring system is designed for use in industrial environments.

The UKCA marking and the technical documentation are available to the responsible authorities according to UKCA directives.

1.4 Intended Use

- The measuring system confocalDT IFD2410/2411/2415 is designed for use in an industrial environment. It is used for
 - Displacement, distance, movement and thickness measurement,
 - measuring the position of parts or machine components
 - The measuring system must only be operated within the limits specified in the technical data see [Chap. 2.4](#).
- The measuring system must only be used in such a way that no persons are endangered or machines are damaged in the event of malfunction or total failure of the sensor.
- Take additional precautions for safety and damage prevention in case of safety-related applications.

1.5 Proper Environment

	confocalDT IFD2410/2415	confocalDT IFD2411	
		Sensor	Controller
Protection class	IP64, front side	IP64, front side	IP40
Operating temperature range	+5 ... +50 °C	+5 ... +70 °C	+5 ... +50 °C
Storage temperature range	-20 ... +70 °C		
Humidity	5 ... 95% (non-condensing)		
Ambient pressure:	Atmospheric pressure		
Shock (DIN EN 60068-2-27)	15 g/6 ms on XY axis, 1000 shocks each		
Vibration (DIN EN 60068-2-6)	2 g / 20 ... 500 Hz on XY axis, 10 cycles each		
EMC	As per EN 61000-6-3 / EN 61326-1 (Class B) Emitted interference; EN 61000-6-2 / EN 61326-1 Immunity to interference		

2. Functional Principle, Technical Data

2.1 Short Description

The measuring systems consists of:



Controller

(IFD2410-x,
IFD2415-x)

Sensor



Controller
(IFC2411)

Optical fiber (sensor
cable)

Sensor
(IFSxxx)

confocalDT IFD2410/2415

With the IFD2410/2415, the sensor and controller form a single unit. It is not possible to exchange the sensor.

confocalDT IFD2411

IFC2411 series controllers can be operated with different sensors. The calibration tables of the sensors required to do so need to be saved in the controller.

The measuring systems use a white LED as an internal light source.

The IFSxxx sensor is passive, since it does not contain any heat sources or moving parts. This prevents heat expansion, which makes for a highly accurate measurement process.

The controller converts the light signals received from the sensor with a spectrometer, calculates distance or thickness values with the integrated signal processor (CPU) and transfers the measured data via the interfaces or analog output.

2.2 Measuring Principle

Polychromatic light (white light) is beamed through the sensor onto the target surface. The sensor's lenses are designed to focus each wavelength of light used at a specific distance through controlled chromatic aberrations. The light reflected by the target surface is received by the sensor on the way back and directed to the controller. This is followed by spectral analysis and the calculation of distances using calibration data saved in the controller.

i The sensor and controller form a single unit, as the linearization table of the sensor is saved in the controller.

This unique measuring principle enables high-precision measurement of applications. It can capture both diffuse and reflective surfaces. With transparent layer materials, a direct thickness measurement can be carried out in addition to the displacement measurement. The transmitter and receiver are arranged on one axis to prevent shadowing.

Excellent resolution and small light spot diameter make it possible to measure surface structures. However, it should be noted that deviations in measured values can occur as soon as the structure is in the order of magnitude of the light spot diameter or the permissible tilt is exceeded, for example at groove walls.

2.3 Term Definitions, Glossary

SMR Start of measuring range. A start of measuring range (SMR) must be kept between each sensor and the target.
Minimal distance between the front sensor face and the target.

MMR Mid of measuring range

EMR End of measuring range (start of measuring range + measuring range)
Maximum distance between the front sensor face and the target.

MB Measuring range

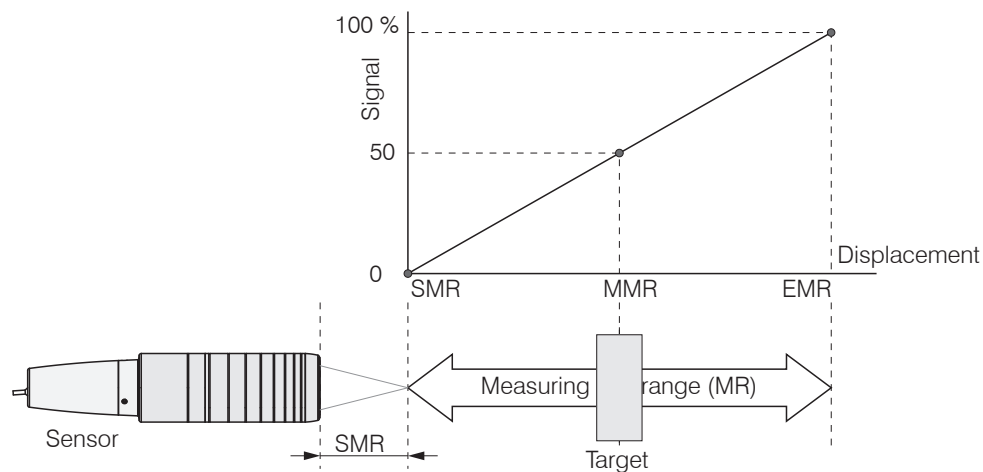

Fig. 1 Measuring range and output measuring system

Minimum target thickness see Chapter Technical Data

Maximum target thickness Sensor measuring range x refractive index of target

2.4 Technical Data for confocalDT IFD2410/2415

Model		IFD2410-1	IFD2410-3	IFD2410-6	IFD2415-1	IFD2415-3	IFD2415-10
Measuring range	Distance	1.0 mm	3.0 mm	6.0 mm	1.0 mm	3.0 mm	10.0 mm
	Minimum thickness	0.05 mm	0.15 mm	0.3 mm	0.05 mm	0.15 mm	0.5 mm
Start of measuring range	approx.	approx. 15 mm	approx. 25 mm	approx. 35 mm	approx. 10 mm	approx. 20 mm	approx. 50 mm
Resolution	Static ¹	< 12 nm	< 36 nm	< 80 nm	< 8 nm	< 15 nm	< 36 nm
	dynamic ²	< 50 nm	< 125 nm	< 250 nm	< 38 nm	< 80 nm	< 204 nm
Measuring rate		Continuously adjustable from 100 Hz to 8 kHz			Continuously adjustable from 100 Hz to 25 kHz		
Linearity ³	Displacement and distance measurement	< ±0.5 μm	< ±1.5 μm	< ±3.0 μm	< ±0.25 μm	< ±0.75 μm	< ±2.5 μm
	Thickness measurements	< ±1.0 μm	< ±3.0 μm	< ±6.0 μm	< ±0.5 μm	< ±1.5 μm	< ±5.0 μm
Multi-layer measurement		-			up to 5 layers		
Light source		Internal white LED					
Permissible ambient light		30,000 lx					
Light spot diameter ⁴		12 μm	18 μm	24 μm	8 μm	9 μm	16 μm
Measuring angle ⁵		±25°	±19°	±10°	±30°	±24°	±17°
Numerical aperture (NA)		0.45	0.35	0.18	0.55	0.45	0.3
Target material		Reflective, diffuse as well as transparent surfaces (e.g. glass)					
Supply voltage		24 VDC ±10 %					
Power consumption		<5.3 W (24 V)			<7 W (24 V)		
Signal input		2 x encoders (A+, A-, B+, B-, Index) 2 x HTL/TTL multifunction input: Trigger in, slave in, zeroing, master, teach; 1 x RS422 synchronization input: Trigger in, sync in, master/slave, master/slave alternating					
Digital interface		EtherCAT / RS422 / (Ethernet for configuration)					
Analog output		4 ... 20 mA / 0 ... 5 V / 0 ... 10 V (16 bit D/A converter)					
Switching output		Error1-Out, Error2-Out					
Digital output		Sync out					
Connection		12-pin M12 connector for supply, encoder, EtherCAT, RS422 and synchronization 17-pin M12 connector for I/O analog and encoder allows optional extension to 3 m / 6 m / 9 m / 15 m (see accessories for suitable connection cables)					
Mounting		Radial clamping, threaded holes, mounting adapter (see accessories)					
Temperature range	Storage	-20 ... +70 °C					
	Operation	+5 ... +50 °C					
Shock (DIN EN 60068-2-27)		15 g/6 ms on XY axis, 1000 shocks each					
Vibration (DIN EN 60068-2-6)		2 g/20 ... 500 Hz on XY axis, 10 cycles each					
Protection class (DIN EN 60529)	Sensor	IP64, front side					
	Controller	IP65					
Material		Aluminum housing, passively cooled					
Weight	approx.	490 g	490 g	490 g	500 g	600 g	800 g
Control and display elements		Correct key: Interface selection, two adjustable functions as well as reset to factory setting after 10 s; 4x color LED for Intensity, Range, RUN and ERR					

All data based on constant ambient temperature (24 ± 2°C)

1) Averaged over 512 values, at 1 kHz, in mid of measuring range on test glass

2) RMS noise in relation to mid of measuring range (1 kHz)

3) Maximum deviation from reference system over the entire measuring range, measured on front surface of ND filter

4) In mid of measuring range

5) Maximum sensor tilt up to which a usable signal on a polished glass (n = 1.5) can be obtained at mid of measuring range, in which the accuracy decreases towards the limit values

2.5 Technical Data confocalDT IFD2411

Model		IFD2411-1	IFD2411-2	IFD2411/90-2	IFD2411-3	IFD2411-6
Measuring range	Distance	1.0 mm	2.0 mm	2.0 mm	3.0 mm	6.0 mm
Start of measuring range	approx.	15 mm	14 mm	9.6 mm ¹	25 mm	35 mm
Resolution	Static ²	< 12 nm	< 40 nm	< 40 nm	< 40 nm	< 80 nm
	dynamic ³	< 50 nm	< 125 nm	< 125 nm	< 125 nm	< 250 nm
Measuring rate	Continuously adjustable from 100 Hz to 8 kHz					
Linearity ⁴	Distance	< ±0.5 μm	< ±1.0 μm	< ±1.0 μm	< ±1.5 μm	< ±3.0 μm
	Thickness	< ±1.0 μm	< ±2.0 μm	< ±2.0 μm	< ±3.0 μm	< ±6.0 μm
Multi-layer measurement	1 layer					
Light source	Internal white LED					
No. of characteristic curves	Saves up to 10 characteristic curves of different sensors, selection via table in the menu					
Permissible ambient light ⁵	30,000 lx					
Light spot diameter		12 μm	10 μm	10 μm	18 μm	24 μm
Measuring angle ⁶		±25°	±12°	±12°	±19°	±10°
Numerical aperture (NA)		0.45	0.25	0.25	0.35	0.18
Minimum thickness ⁷		0.05 mm	0.1 mm	0.1 mm	0.15 mm	0.3 mm
Target material	Reflective, diffuse as well as transparent surfaces (e.g. glass)					
Synchronization	yes					
Supply voltage	24 VDC ±10 %					
Power consumption	<max. 7 W (24 V)					
Signal input	Sync-In / trig-In; 1 x encoder (A+, A-, B+, B-, Index)					
Digital interface	EtherCAT / RS422 / (Ethernet for configuration)					
Analog output	Current: 4 ... 20 mA; current: 0 ... 5V & 0 ... 10 V (16 bit D/A converter)					
Digital output	Sync-out					
Connection	Optical	Plug-in optical fiber via E2000 connector, length 2 m ... 50 m, min. bending radius 30 mm				
	Electrical	3-pin supply terminal block; 5-pin I/O terminal block (max. cable length 30 m); 17-pin M12 connector for RS422, analog and encoder; RJ45 connector for Ethernet (out) / EtherCAT (in/out) (max. cable length 100 m)				
Mounting	free-standing, DIN rail mounting					
Temperature range	Storage	-20 ... +70 °C				
	Operation	Sensor: +5 ... +70 °C Controller: +5 ... +50 °C				
Shock (DIN-EN60068-2-27)	15 g/6 ms on XYZ axis, 1000 shocks each					
Vibration (DIN EN 60068-2-6)	2 g/20 ... 500 Hz on XYZ axis, 10 cycles each					
Protection class (DIN-EN60529)	Sensor	IP64				
	Controller	IP40				
Material	Aluminum					
Weight	Sensor	Approx. 100 g	Approx. 20 g	Approx. 30 g	Approx. 100 g	Approx. 100 g
	Controller	Approx. 335 g				
No. of measurement channels ⁸	1					
Control and display elements	Multifunction key: Interface selection, two adjustable functions as well as reset to factory setting after 10 s; 4x color LED for Intensity, Range, RUN and ERR					

FSO = Full Scale Output

1) Start of measuring range measured starting at sensor axis

2) Averaged over 512 values, at 1 kHz, in mid of measuring range on test glass

3) RMS noise in relation to mid of measuring range (1 kHz)

4) All data based on constant ambient temperature (25 ± 1°C) with measurement on plane-parallel test glass; data may deviate with other targets

5) Light type: Incandescent lamp

6) Maximum sensor measuring angle up to which a usable signal on a reflective surface can be obtained at mid of measuring range, in which the accuracy decreases towards the limit values

7) Pane of glass with refractive index n = 1.5 in mid of measuring range

8) No loss of intensity and linearity thanks to two synchronous measuring channels

3. Delivery

3.1 Scope of Delivery confocalDT IFD2410/2415

1 Sensor IFD241x-x

1 PC2415-1/Y Length 1 m

1 acceptance report

1 quick manual

▶ Carefully remove the components of the measuring system from the packaging and ensure that the goods are forwarded in such a way that no damage can occur.

▶ Check the delivery for completeness and shipping damage immediately after unpacking.

▶ If there is damage or parts are missing, immediately contact the manufacturer or supplier.

3.2 Scope of Delivery confocalDT IFD2411

1 Controller IFC2411

1 Sensor with sensor cable IFS2404-x

1 RJ patch cable Cat5 2 m

1 acceptance report

1 quick manual

▶ Carefully remove the components of the measuring system from the packaging and ensure that the goods are forwarded in such a way that no damage can occur.

▶ Check the delivery for completeness and shipping damage immediately after unpacking.

▶ If there is damage or parts are missing, immediately contact the manufacturer or supplier.

3.3 Storage

Temperature range for storage: -20 ... +70 °C

Humidity: 5 ... 95% (non-condensing)

• Protect the lens of the sensor from getting dirty.

• Protect the ends of the sensor cable (optical fibers) from getting dirty (applies to the IFD2411).

4. Mounting

4.1 Preliminary Remarks

The optical sensors/measuring systems of the confocalDT IFD2410/2411/2415 series measure in the nanometer range. Observe the maximum tilt between sensor and target.

i Ensure careful handling during installation and operation!

4.2 confocalDT IFD2410/2415

4.2.1 Circumferential Clamping

▶ Mount the IFD241x using a mounting adapter.



Fig. 2 Circumferential clamping with MA240x mounting ring, consisting of mounting block and mounting ring

i Micro-Epsilon recommends using the circumferential clamping.

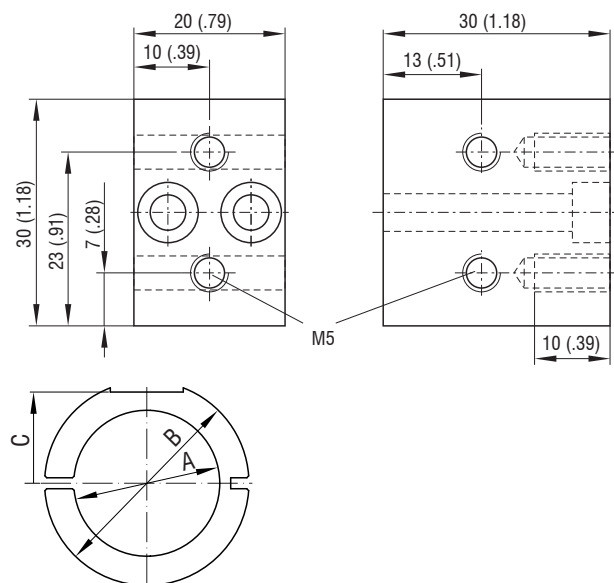

Mounting ring	Dimension A	Dimension B	Dimension C
MA2400-27	ø27	ø46	19.75
MA2405-34	ø34	ø50	22
MA2405-54	ø54	ø70	32

Fig. 3 Mounting block and mounting ring MA240x

4.2.2 Direct Screw Connection

► Mount the IFD241x using three M3 screws.

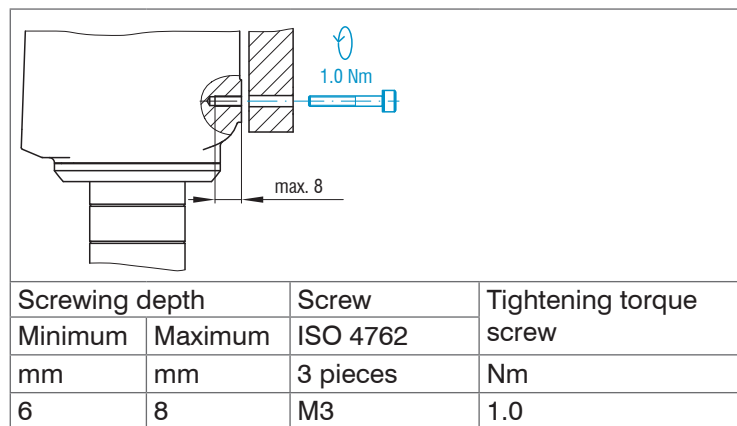

Fig. 4 Installation conditions IFD2410 | IFD2415

IFD2410-	1	3	6	IFD2415-	1	3	10
MR	1	3	6	MR	1	3	10
SMR	15	25	35	SMR	10	20	50
A	56			A	82	85	118
B	33			B	59	62	---
C	150			C	176	179	212
D	27			D	27	34	54

Dimension in millimeters

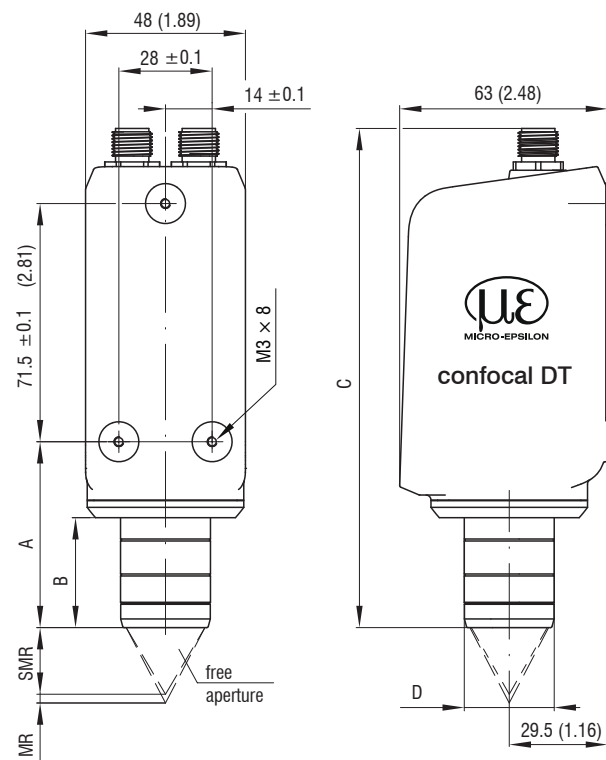

Fig. 5 Dimensional drawing IFD2410 | IFD2415, dimensions in mm

The support surfaces around the fastening holes are slightly raised.

4.2.3 Electrical Connections, Pin Assignment

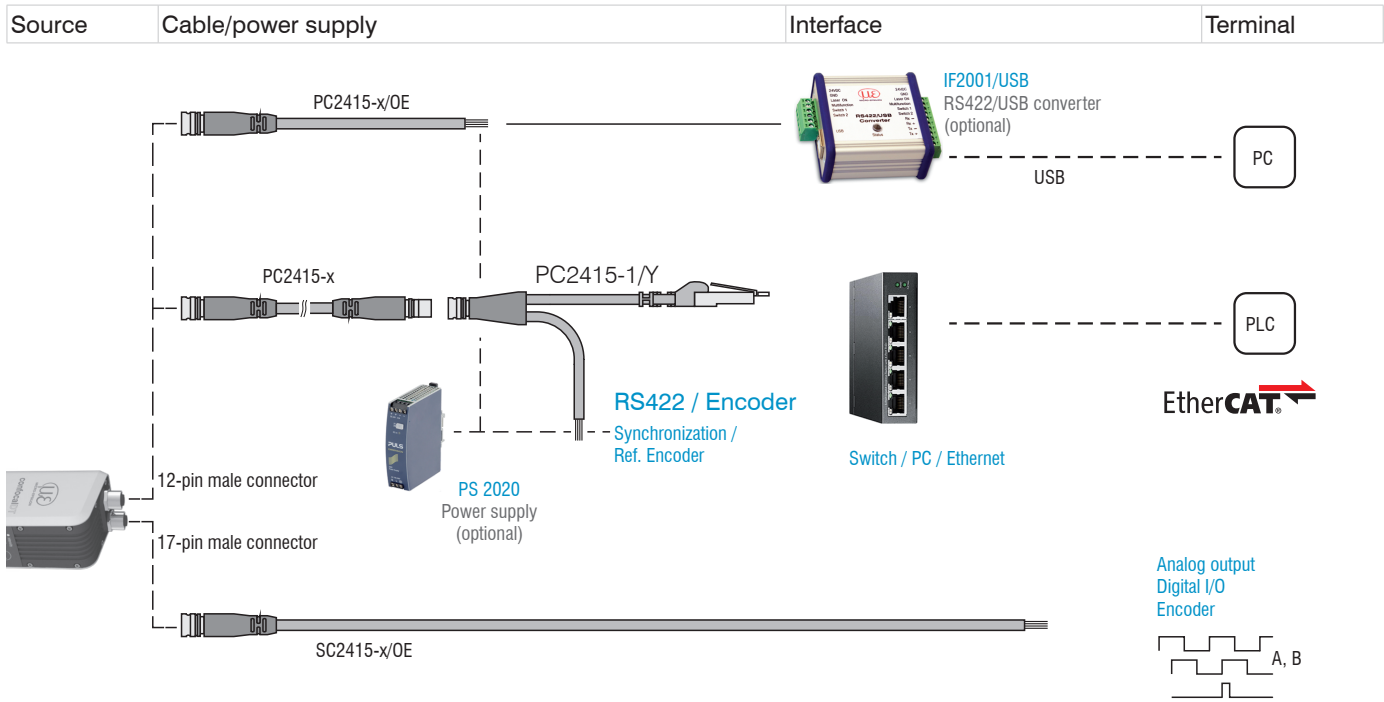

Fig. 6 Connection examples for confocalDT IFD2411/2415

IFD2410/2415, 12-pin connector		PC2415-x/OE	PC2415-1/Y		IF2001
Signal	Pin	Wire color	Wire color	RJ45, pin	Signal
V ₊	1	Red	Red	---	24VDC
Supply GND	2	Blue	Blue	---	GND
Data Rx+	Encoder 2A+ ¹	Brown	Brown	---	Tx+
Data Rx-	Encoder 2A-	White	White	---	Tx-
Data Tx+	Encoder 2B+	Green	Green	---	Rx+
Data Tx-	Encoder 2B-	Yellow	Yellow	---	Rx-
SYNC+	Encoder 2Ref+	Gray	Gray	---	---
SYNC-	Encoder 2Ref-	Pink	Pink	---	---
Shield	Housing	Black	Black	---	---
Industrial Ethernet	9	White/green	---	3	---
	10	Green	---	6	---
	11	White/orange	---	1	---
	12	Orange	---	2	---

Fig. 7 Pin assignment for 12-pin sensor connector

The PC2415-1/Y cable is included in the scope of delivery.

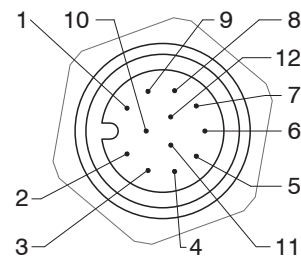

Fig. 8 12-pin sensor connector, pin side

1) The pins can be used for either:
 - serial communication (TIA/EIA-422-B) and synchronization or
 - encoder signals.

IFD2410/2415, 17-pin connector		SC2415-x/OE
Signal	Pin	Wire color
Analog output	1	White, inside
Analog GND	2	Black
Switching output 2 GND	3	Black
Switching output 2	13	Purple
Multifunction input 1	5	Red
Multifunction input 2	14	Blue
Encoder 1B+	8	Gray
Encoder 1B-	15	Pink
Encoder 1Ref+	9	Green
Encoder 1Ref-	16	Yellow
Switching output 1 GND	10	Brown
Switching output 1	11	White
Encoder 1A-	12	Red/blue
Encoder 1A+	17	Gray/pink
Shield	Housing	Black

Fig. 10 Pin assignment for 17-pin sensor connector

The SC2415-x/OE cable is available as an optional accessory.

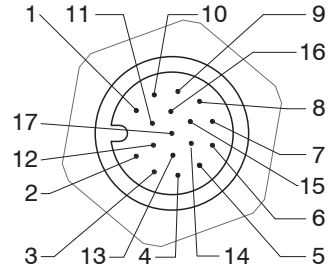

Fig. 9 17-pin sensor connector, pin side

4.2.4 Grounding Concept, Shielding

All inputs and outputs are galvanically connected to the power supply ground (supply GND); the Ethernet/EtherCAT connections are potential-free.

The ground connections (supply GND, switching output GND and analog GND) of each connection group are galvanically connected to one another by filters.

The shield connections of each connection group are only connected to the controller housing. They are used to connect the cable shieldings for individual connections (power, analog output, switching outputs, synchronization and trigger input).

- For reasons of interference resistance, use the corresponding GND connection for the analog output and the two switching outputs. Only use shielded cables shorter than 30 m and connect the cable shield to the shield or the connector housings.

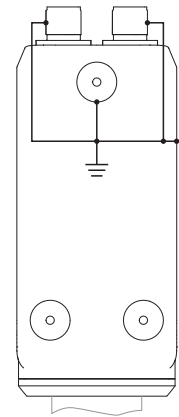

4.2.5 Supply Voltage (Power)

Nominal value: 24 V DC (20 ... 28 V, $P < 7$ W).

The sensor is supplied via cable PC2415-1/Y or PC2415-x/OE.

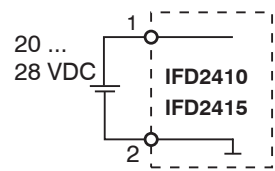

IFD2410/2415 12-pin connector	Power supply	PC2415-1/Y PC2415-x/OE
1	V_+	Red
2	GND	Blue

Only turn on the power supply after wiring has been completed.

- Connect the inputs for pin 1 and pin 2 on the sensor to a 24 V power supply.

- Power supply only for measuring devices, not to be used for drives or similar sources of impulse interference at the same time. MICRO-EPSILON recommends using the optionally available PS2020 power supply, for the sensor.

4.2.6 RS422

In addition to Industrial Ethernet, the IFD2410/2415 also supports serial communication via RS422. The PC2415-1/Y or PC2415-x/OE cables enable serial communication. The IF2001/USB RS422-to-USB converter is available as an optional accessory.

- Differential signals to EIA-422, galvanically connected to supply voltage.
- Receiver Rx with 120 Ohm internal terminating resistor.

- Use a shielded cable with twisted wires. Cable length less than 30 m.
- Connect the ground connections.

IFD2410/2415 12-pin connector	Signal	PC2415-1/Y PC2415-x/OE	IF2001/USB
3	RX +	Brown	TX +
4	RX -	White	TX -
2	Supply GND (blue)		GND
5	TX +	Green	RX +
6	TX -	Yellow	RX -
Housing	Shield	Cable shield	---

4.2.7 Ethernet, EtherCAT

Connection

- with an Ethernet network (PC) or
- with the EtherCAT bus system (IN port).

IFD2410/2415, 12-pin connector		PC2415-x/OE	PC2415-1/Y
Signal	Pin	Wire color	RJ45, pin
Industrial Ethernet	9	White/green	3
	10	Green	6
	11	White/orange	1
	12	Orange	2

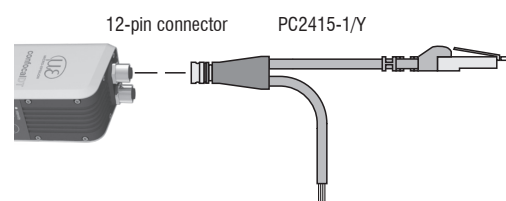

- Connect the IFD2410/2415 and network with a shielded Ethernet cable (Cat5E, 2 m patch cable from the scope of delivery, total cable length shorter than 100 m).

The two LEDs `RUN` and `ERR` indicate that the connection was successful and is active.

The measuring device can be configured via SDOs (EtherCAT), the web interface or by ASCII commands at command level (e.g. Telnet).

4.2.8 Analog Output

The alternative analog output (voltage or current) is connected to the 17-pin sensor plug and is galvanically connected to the supply voltage.

IFD2410/2415, 17-pin connector		SC2415-x/OE
Signal	Pin	Wire color
Analog output	1	White, inside
Analog GND	2	Black ¹

Voltage: Pin V_{out} and Pin GND,

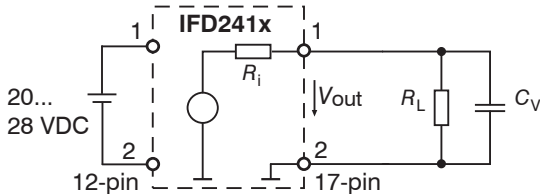

R_i approx. 50 Ohm, $R_L > 10$ MOhm

Slew rate (without C_V , $R_L \geq 1$ kOhm) typ. 0.5 V/ μ s

Slew rate (with $C_V = 10$ nF, $R_L \geq 1$ kOhm) typ. 0.4 V/ μ s

Current: Pin I_{out} and Pin GND

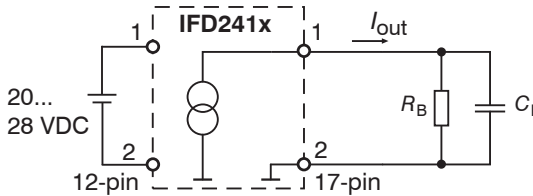

$R_B \leq 500$ Ohm

Slew rate (without C_I , $R_B = 500$ Ohm) typ. 1.6 mA/ μ s

Slew rate (with $C_I = 10$ nF, $R_B = 500$ Ohm) typ. 0.6 mA/ μ s

➡ Use a shielded cable. Cable length less than 30 m.

As an alternative, the output range can be set to the following values:

Voltage: 0 ... 5 V; 0 ... 10 V;

Current: 4 ... 20 mA.

The measured values can only be output as voltage or current.

1) Analog output in shielded cable area

4.2.9 Multifunction inputs

A switching transistor with an open collector (e.g. in an optocoupler), a relay contact or a digital TTL or HTL signal are suitable for switching.

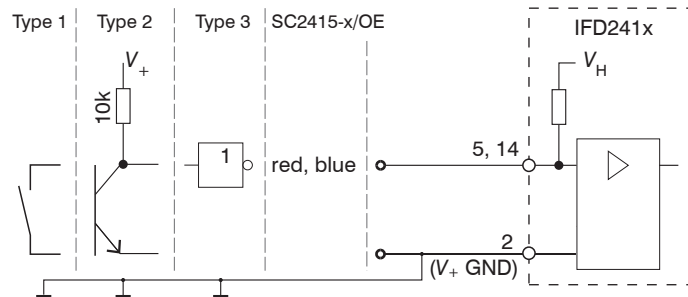

The inputs are not electrically separated.

24V logic (HTL): Low ≤ 3 V; High ≥ 8 V (max 30 V),

5V logic (TTL): Low ≤ 0.8 V; High ≥ 2 V

Minimal pulse width 50 μ s

Internal pull-up resistor, an open input is detected as High.

Maximum switching frequency 25 kHz

An external resistor is not required for current limitation. The ground of the logic circuit must be galvanically connected to the supply ground.

4.2.10 Switching Outputs (digital I/O)

The GND connections of the switching outputs are separated from the supply GND by filters.

The switching behavior (NPN, PNP, Push-Pull) is programmable I_{max} 100 mA.

The maximum auxiliary voltage for a switching output with NPN switching behavior is 28 V.

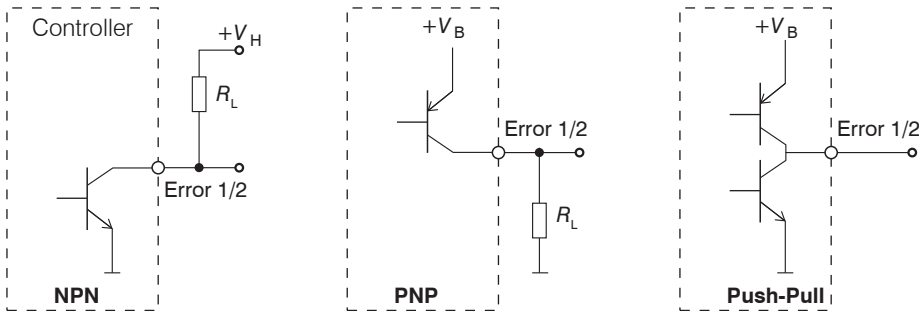

Fig. 11 Output characteristics and circuitry of the TTL switching outputs Error 1/2

IFD2410/2415, 17-pin connector		SC2415-x/OE
Signal	Pin	Wire color
Switching output 2 GND	3	Black
Switching output 2	13	Purple
Switching output 1 GND	10	Brown
Switching output 1	11	White

All GND conductors are interconnected with one another and to the supply ground.

➤ Use a shielded cable. Cable length less than 30 m.

Output level (without load resistor) at a supply voltage of 24 VDC	Low < 1 V; High > 23 V
Saturation voltage at $I_{max} = 100$ mA	Low < 2.5 V (output - GND)
	High < 2.5 V (output - + V_B)

The saturation voltage is measured:

- between output and GND, at output = Low, or
- between output and V_B , at output = High.

Name	Output active (error)	Output passive (no error)
NPN (Low side)	GND	+ V_B
PNP (High side)	+ V_B	GND
Push-pull	+ V_B	GND
Push-pull, negative	GND	+ V_B

Fig. 12 Switching behavior of the switching outputs

NOTICE

The load resistor R_L can be dimensioned according to the limit values ($I_{max} = 100$ mA, $V_{Hmax} = 28$ V). When connecting inductive loads, such as a relay, the parallel protective diode must not be missing.

4.2.11 Synchronization (Inputs/Outputs)

4.2.11.1 General

- The SYNC+ and Sync- pins on the 12-pin sensor connector: Symmetrical output/input for synchronization of two or more sensors
- The pins multifunction input 1 or multifunction input 2 on the 17-pin sensor connector: Input for synchronization of a sensor with an external synchronization source, such as a function generator
- The termination resistor R_T (120 Ohm) can be switched on or off via software.

4.2.11.2 Internal Synchronization

An IFD2410/2415 (master) synchronizes one or more sensors (slaves).

IFD2410/2415, 12-pin connector			PC2415-x/OE	PC2415-1/Y
Signal	Pin	Level	Wire color	Wire color
Supply GND	2		Blue	Blue
SYNC+	7	RS422 (EIA422)	Gray	Gray
SYNC-	8		Pink	Pink

Fig. 13 Connections and signal level internal synchronization

➤ Activate the termination resistor (120 Ohm) in the last sensor (slave n) in the chain.

Star synchronization

- Connect pins Sync+ and Sync- from sensor 1 (master) in a star shape to pins Sync+ and Sync- from sensor 2 (slave) to sensor n, in order to synchronize two or more sensors to one another, see Fig. 14
- Sub-loop length less than 30 m in star synchronization

Chain synchronization

- Connect pins Sync+ and Sync- from sensor 1 (master) to pins Sync+ and Sync- from sensor 2 (slave 1). Connect the pins of the following sensors to synchronize two or more sensors to one another, see Fig. 14
- Total line length less than 30 m in chain synchronization

- Use shielded cables with twisted wires.
- Connect the cable shield to the housing.
- Program sensor 1 to Master and all other sensors to Slave.



Fig. 14 Synchronization of multiple sensors, star-shaped on the left, daisy-chained on the right

➤ Connect all GND connections of the supply to one another if the sensors are not fed by a common power supply.

i If the sensors are operated by way of the EtherCAT interface, then synchronization can also be achieved without the sync line.

4.2.11.3 External Synchronization

An external synchronous source synchronizes one or more IFD2410/2415 (slaves).

IFD2410/2415, 17-pin connector				SC2415-x/OE
Signal	Pin	Level		Wire color
Multifunction input 1	5	TTL Low Level $\leq 0.8\text{ V}$; High Level $\geq 2\text{ V}$ Minimal pulse width $50\ \mu\text{s}$	HTL Low Level $\leq 3\text{ V}$; High Level $\geq 8\text{ V}$ (max. 30 V) Minimal pulse width $50\ \mu\text{s}$	Red
Multifunction input 2	14			Blue

IFD2410/2415, 12-pin connector		PC2415-x/OE	PC2415-1/Y
Signal	Pin	Wire color	Wire color
Supply GND	2	Blue	Blue

Fig. 15 Connections and signal level external synchronization

- Activate the termination resistor (120 Ohm) in the last sensor (slave n) in the chain.

Star synchronization

- Connect the pin multifunction input 1 or 2 of slave 1 to the external synchronization source.
- Connect the supply GND of the sensor to the ground connection of the synchronization source.

Further sensors can be synchronized in the same schematic.

- Sub-loop length less than 30 m in star synchronization

- Use shielded cables with twisted wires.
- Connect the cable shield to the housing.
- Program all sensors to Slave.

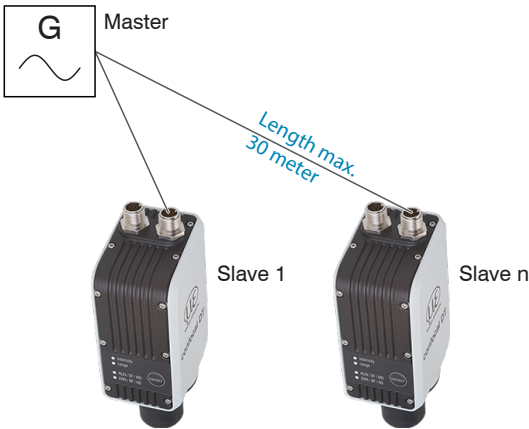

Fig. 16 Synchronization of multiple sensors, star-shaped

- Connect all GND connections of the supply to one another if the sensors are not fed by a common power supply.
- i** If the IFD2410/2415 are operated by way of the EtherCAT interface, then synchronization can also be achieved without the sync line.

4.2.12 Triggering

4.2.12.1 General

Data recording or output can be triggered with:

- multifunction inputs 1/2,
- synchronization inputs Sync+ and Sync-,
- encoder 1.

➤ Use a shielded cable with twisted wires. Cable length less than 30 m.

Switching contacts, transistors (NPN, N-channel FET) or PLC outputs can be used as trigger sources.

4.2.12.2 Triggering with Multifunction Input

IFD2410/2415, 17-pin connector			SC2415-x/OE	
Signal	Pin	Level		Wire color
Multifunction input 1	5	TTL Low Level ≤ 0.8 V; High Level ≥ 2 V Minimal pulse width 50 μ s	HTL Low Level ≤ 3 V; High Level ≥ 8 V (max. 30 V) Minimal pulse width 50 μ s	Red
Multifunction input 2	14			Blue

➤ Connect the pin multifunction input 1 or 2 to the external trigger source.

➤ Connect the supply GND of the sensor to the ground connection of the external trigger source.

Program the sensor's multifunction input connections to the trigger input function.

4.2.12.3 Triggering with Synchronization Input

IFD2410/2415, 12-pin connector			PC2415-x/OE	PC2415-1/Y
Signal	Pin	Level	Wire color	Wire color
SYNC+	7	RS422 (EIA422)	Gray	Gray
SYNC-	8		Pink	Pink

➤ Connect pins Sync+ and Sync- to the external trigger source.

Program the sensor's sync connections to the trigger input function.

The trigger source (master) must supply a symmetrical output signal according to the RS422 standard. For asymmetrical trigger sources, Micro-Epsilon recommends inserting the SU4 level converter (3 channels TTL/HTL to RS422) between trigger signal source and sensor.

4.2.12.4 Triggering with Input Encoder 1

A connected encoder at the encoder 1 inputs can be used for triggering.

IFD2410/2415, 17-pin connector			SC2415-x/OE
Signal	Pin	Level	Wire color
Encoder 1B+	8	RS422 (EIA422)	Gray
Encoder 1B-	15		Pink
Encoder 1A-	12		Red/blue
Encoder 1A+	17		Gray/pink

Program the encoder's sync connections to the trigger input function.

4.2.13 Encoder Inputs

The measuring system supports up to three encoders.

Two encoder inputs:

- Incremental signals A, B
- Reference pulse

The maximum pulse frequency is 1 MHz.

RS422 level (symmetrical) for A, B, Ref

IFD2410/2415, 12-pin connector		PC2415-x/OE	PC2415-1/Y
Signal	Pin	Wire color	Wire color
Supply GND	2	Blue	Blue
Encoder 2A+ ¹	3	Brown	Brown
Encoder 2A-	4	White	White
Encoder 2B+	5	Green	Green
Encoder 2B-	6	Yellow	Yellow
Encoder 2Ref+	7	Gray	Gray
Encoder 2Ref-	8	Pink	Pink

IFD2410/2415, 17-pin connector		SC2415-x/OE
Signal	Pin	Wire color
Encoder 1B+	8	Gray
Encoder 1B-	15	Pink
Encoder 1Ref+	9	Green
Encoder 1Ref-	16	Yellow
Encoder 1A-	12	Red/blue
Encoder 1A+	17	Gray/pink

Fig. 17 Pin assignment for two encoder inputs

Three encoder inputs:

- Incremental signals A, B

The maximum pulse frequency is 1 MHz; no reference pulse.

RS422 level (symmetrical) for A, B, Ref

IFD2410/2415, 12-pin connector		PC2415-x/OE	PC2415-1/Y
Signal	Pin	Wire color	Wire color
Supply GND	2	Blue	Blue
Encoder 2A+ ¹	3	Brown	Brown
Encoder 2A-	4	White	White
Encoder 2B+	5	Green	Green
Encoder 2B-	6	Yellow	Yellow
Encoder 3B+	7	Gray	Gray
Encoder 3B-	8	Pink	Pink

IFD2410/2415, 17-pin connector		SC2415-x/OE
Signal	Pin	Wire color
Encoder 1B+	8	Gray
Encoder 1B-	15	Pink
Encoder 3A+	9	Green
Encoder 3A-	16	Yellow
Encoder 1A-	12	Red/blue
Encoder 1A+	17	Gray/pink

Fig. 18 Pin assignment for three encoder inputs

➡ Use a shielded cable. Cable length shorter than 3 m. Connect the cable shield to the housing.

Connection conditions

- The encoders must supply symmetrical RS422 signals.
- If there are no RS422 outputs on the encoder, Micro-Epsilon recommends inserting the SU4 level converter (3 channels TTL/HTL to RS422) between trigger signal source and controller.

1) If encoders 2 and 3 are used, neither serial communication via RS422 and nor synchronization of the IFD2410/2415 will be possible.

4.3 confocalDT 2411

4.3.1 IFC2411 Controller

The IFC2411 controller can be placed on a flat surface or mounted with a TH 35 top-hat rail according to DIN EN 60715, e.g. in a control cabinet. Mindestabstand benachbarter Controller beträgt 10 mm. The minimum distance between controllers is 10 mm.

- Position the controller so that the connections, controls and displays are not concealed.

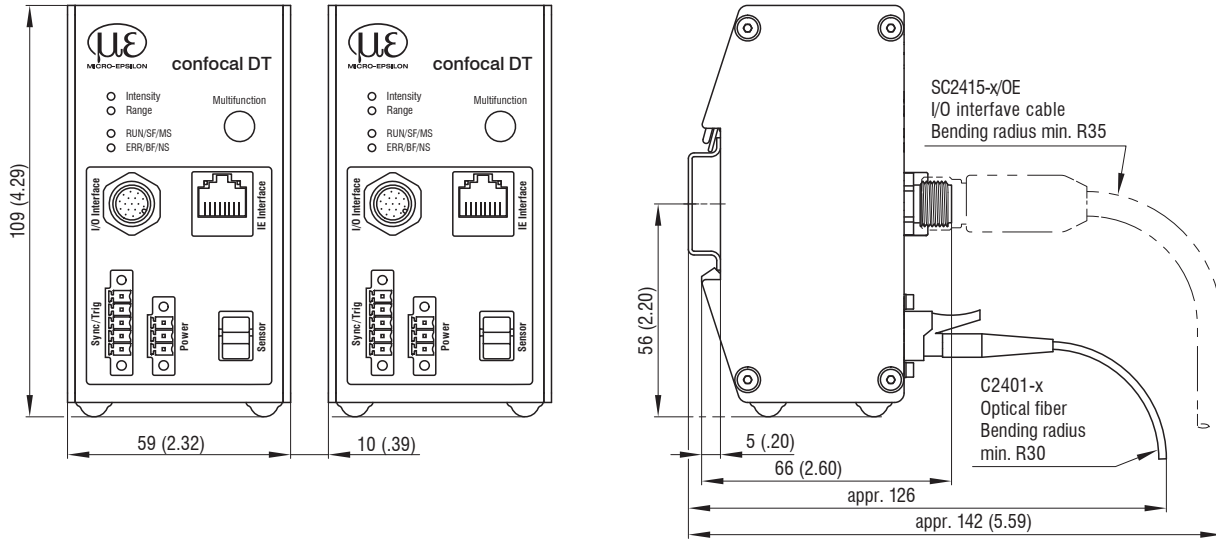

Fig. 19 IFC2411 dimensional drawing, dimensions in mm

4.3.2 Sensor Cable, Optical Fiber

The sensor is connected to the controller by means of an optical fiber.

- Do not shorten or extend the optical fiber.
- Do not pull or carry the sensor by the cable.
- The glass fiber has a diameter of 50 μm .

The connector must not be dirty under any circumstances, as this will cause particles to build up in the controller and severe loss of light. The plugs may only be cleaned by persons with the appropriate expertise using a fiber microscope for control.

General Rules

Do not

- getting the plugs dirty, e.g. through dust or fingerprints, and unnecessary plugging operations
- applying any mechanical stress to the optical fiber (bending, pinching, pulling, drilling, knotting, etc.)
- tight curvature of the cable, because the glass fiber is damaged in the process and this causes permanent damage through microscopic cracks

Never bend the sensor cable more tightly than the permitted bending radius.

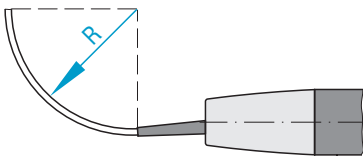

If the cable is immovably routed:

$R = 30 \text{ mm}$ or more

If the cable is movably routed:

$R = 40 \text{ mm}$ or more

Do not kink the sensor cable.

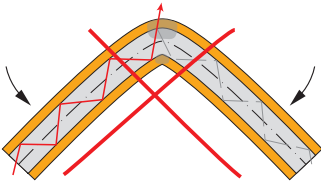

Do not pull the sensor cable over sharp edges.

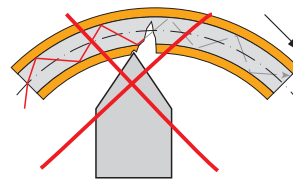

Do not crush the sensor cable, do not use cable ties to secure it.

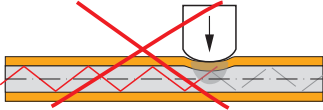

Do not pull on the sensor cable.

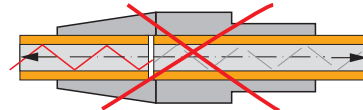

Connect sensor cable to controller

- Remove the dummy plug of the green optical fiber socket sensor on the controller.
- Plug the sensor cable with green plug (E2000/APC) into the optical fiber socket, making sure that the sensor connector is properly oriented.
- Insert the sensor plug until it locks into place.



Connect sensor cable to controller

- Press down the release lever on the sensor plug and pull the sensor connector out of the socket.
- Re-insert the dummy plug.

Close the optical inputs/outputs with protective caps when no optical fiber cable is connected.

Connect sensor cable to sensor

- Remove the dummy plugs from the sensor and sensor cable.
- Insert the sensor cable into the optical fiber socket. Make sure that the sensor connector is properly oriented.
- Screw the sensor and sensor cable together with the knurled-head screw on the sensor cable.

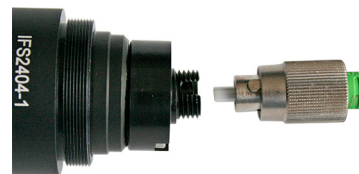

i Pay attention to the orientation of the socket and guide lug.

Fig. 20 Groove of the socket on the sensor (left) and guide lug of an FC sensor plug (right)

Connect sensor cable to sensor

- Open the knurled-head screw on the sensor cable. Disconnect the sensor cable from the sensor.
- Stop up the sensor and sensor cable with the dummy plugs.

4.3.3 Dimensional Drawing of Sensors

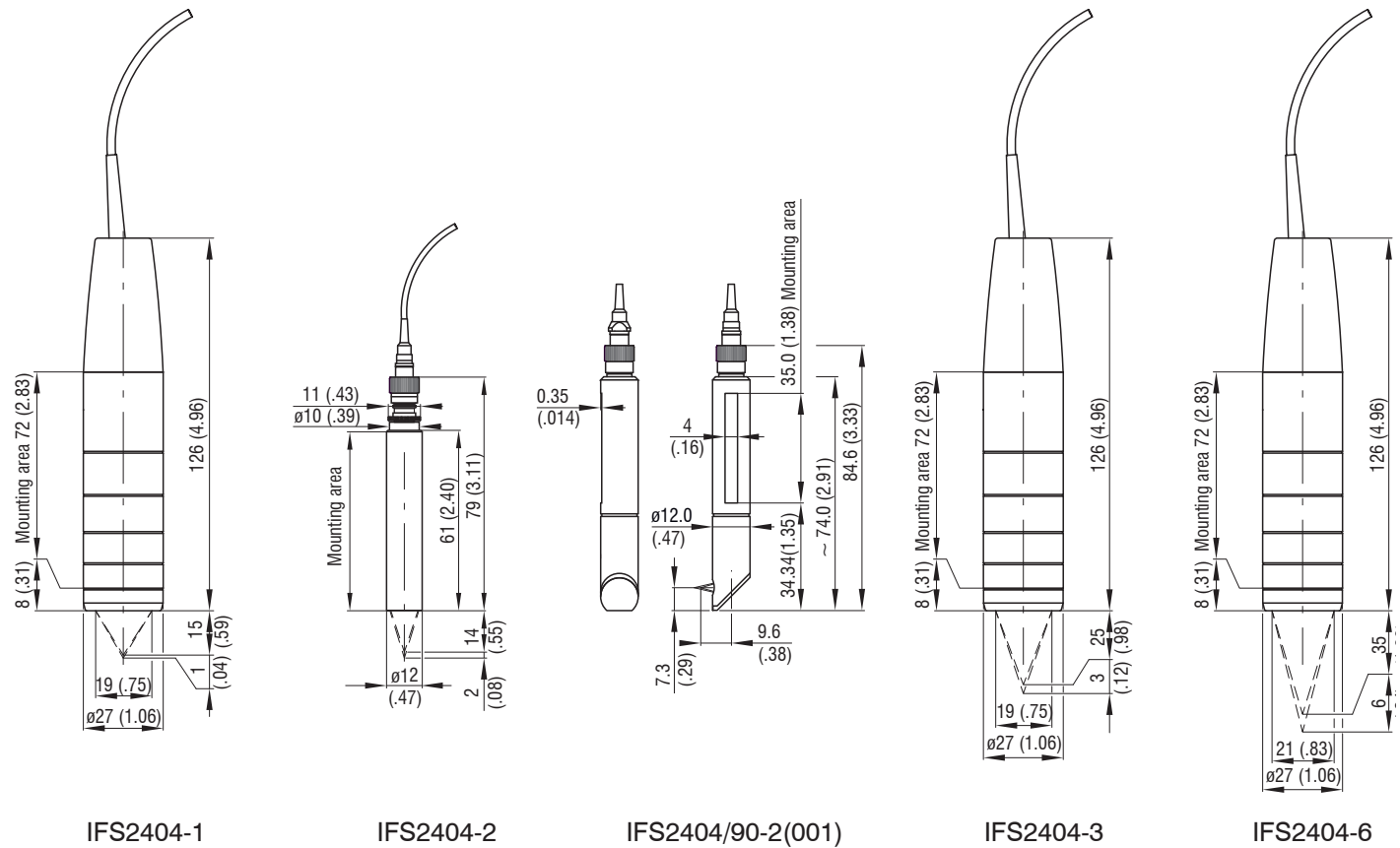

4.3.4 Fastening, Mounting Adapter

4.3.4.1 General

The sensors measure in the nanometer range. Observe the maximum tilt between sensor and target.

- Ensure careful handling during installation and operation!

Fasten the sensors with a circumferential clamp. This type of sensor mounting ensures the highest level of reliability because the sensor's cylindrical housing is clamped over a relatively large area. It is essential to have in difficult installation situations, such as on machines, production lines, etc.

4.3.4.2 Circumferential Clamping

▶ Mount the IFS2404-1 (IFD2411-1), IFD2404-3 (IFD2411-3) and IFD2404-6 (IFD2411-6) sensors using an MA240x mounting adapter.

Mounting ring	Dimension A	Dimension B	Dimension C
MA2400-27	ø27	ø46	19.75

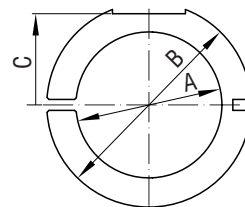

Fig. 21 Mounting ring MA2400-27

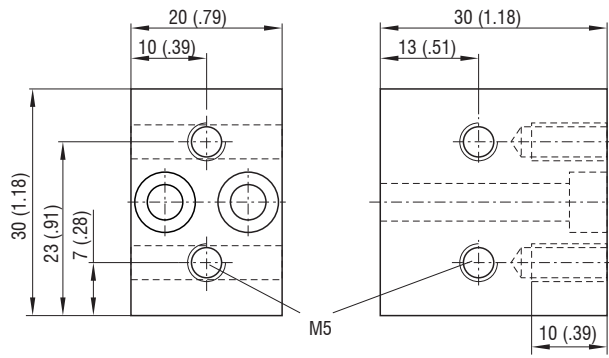

Fig. 22 Mounting block MA240x

▶ Mount the IFS2404-2 (IFD2411-2) sensors using an MA2404-12 mounting adapter.

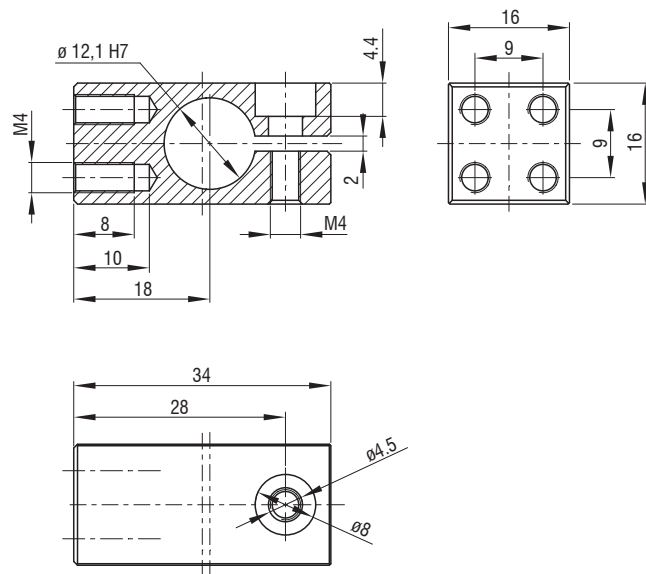

Fig. 23 Mounting block MA2404-12

4.3.5 Electrical Connections, Pin Assignment

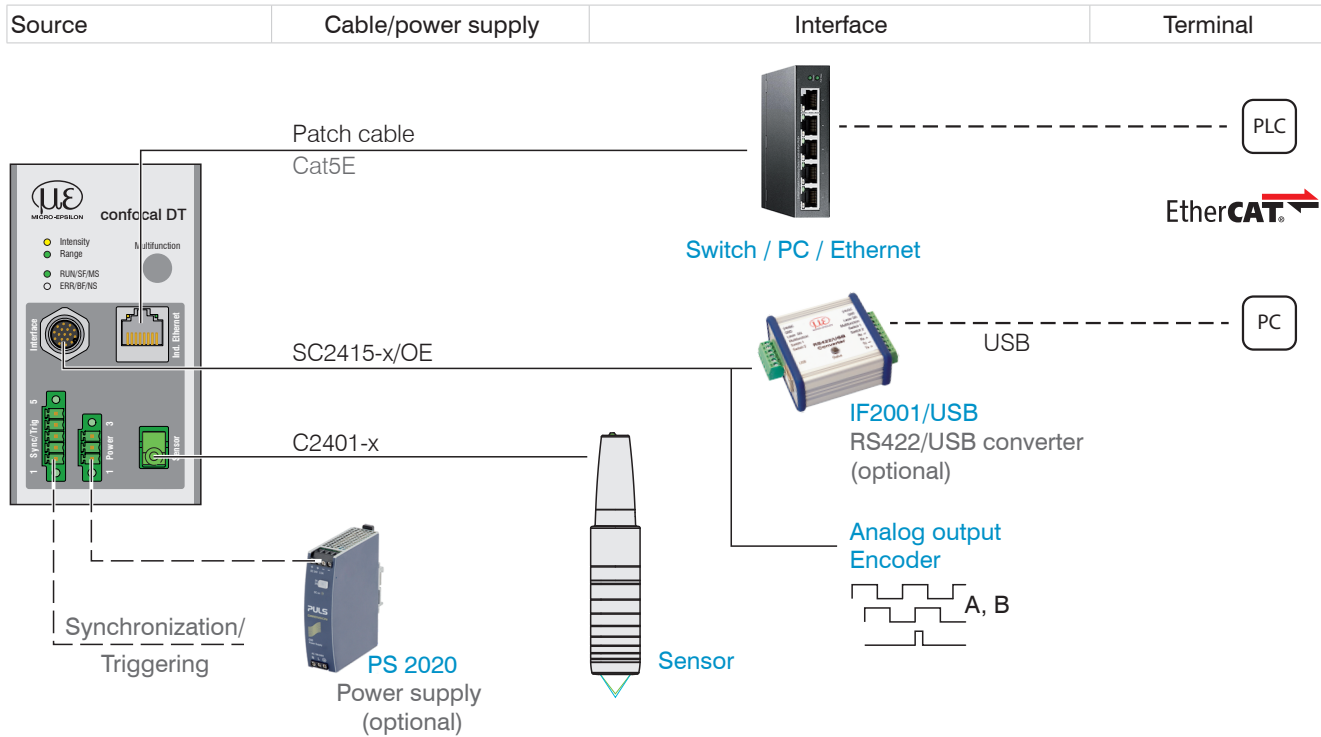
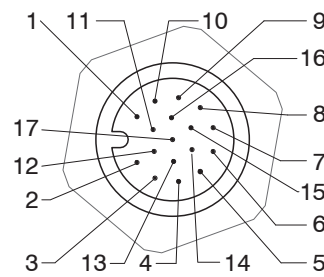

Fig. 24 Connection examples for confocalDT IFD2411

IFC2411, 17-pin connector		SC2415-x/OE
Signal	Pin	Wire color
Analog output	1	white, inside
Analog GND	2	black ¹
Data Tx-	3	black
Data Tx+	13	purple
n.c.	5	red
n.c.	14	Blue
Encoder 1B+	8	Gray
Encoder 1B-	15	Pink
Encoder 1Ref+	9	Green
Encoder 1Ref-	16	Yellow
Data Rx+	10	Brown
Data Rx-	11	White
Encoder 1A-	12	red/blue
Encoder 1A+	17	gray/pink
Shield	Housing	Black

The SC2415-x/OE cable is available as an optional accessory.



17-pin sensor connector, pin side

Fig. 25 Pin assignment for 17-pin controller connector, pin side

4.3.6 Grounding Concept, Shielding

All inputs and outputs are galvanically connected to the power supply ground (supply GND); the Ethernet/EtherCAT connections are potential-free.

The ground connections (supply GND and analog GND) of each connection group are galvanically connected to one another by filters.

The shield connections of each connection group are only connected to the controller housing. They are used to connect the cable shieldings for individual connections (power, analog output, switching outputs, synchronization and trigger input).

- For reasons of interference resistance, use the corresponding GND connection for the analog output.
- Only use shielded cables shorter than 30 m and connect the cable shield to the shield or the connector housings.

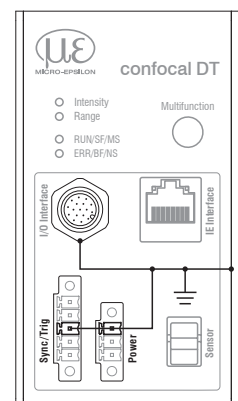

4.3.7 Supply Voltage (Power)

Nominal value: 24 V DC (20 ... 28 V, $P < 7 \text{ W}$).

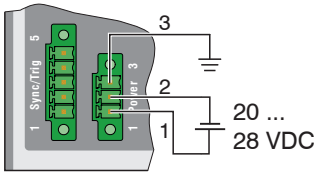

IFC2411 3-pin clamping sleeve	Power supply
1	V_+
2	GND
3	Shield

Only turn on the power supply after wiring has been completed.

➡ Connect the inputs for pin 1 and pin 2 on the controller to a 24 V power supply.

ⓘ Power supply only for measuring devices, not to be used for drives or similar sources of pulse interference at the same time. MICRO-EPSILON recommends using the optionally available PS2020 power supply, for the sensor.

4.3.8 RS422

In addition to Industrial Ethernet, the IFC2411 also supports serial communication via RS422. The SC2415-x/OE cable enables serial communication. The IF2001/USB RS422-to-USB converter is available as an optional accessory.

- Differential signals to EIA-422, galvanically connected to supply voltage.
- Receiver Rx with 120 Ohm internal terminating resistor.

➡ Use a shielded cable with twisted wires. Cable length less than 30 m.

➡ Connect the ground connections.

IFC2411 17-pin connector	Signal	SC2415-x/OE	IF2001/USB
3	Tx -	Black	Rx -
13	Tx +	Purple	Rx +
10	Rx +	Brown	Tx +
11	Rx -	White	Tx -
Housing	Shield	Cable shield	---

4.3.9 Ethernet, EtherCAT

Connection

- with an Ethernet network (PC) or
- with the EtherCAT bus system (IN port).

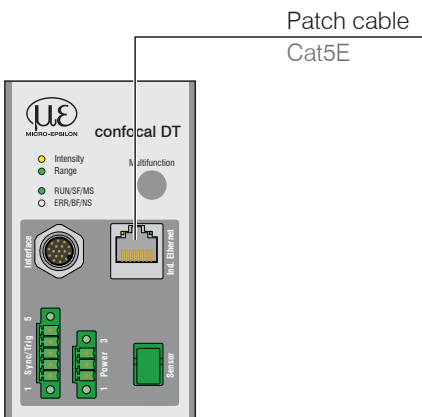

➡ Connect the IFC2411 and network with a shielded Ethernet cable (Cat5E, 2 m patch cable from the scope of delivery, total cable length shorter than 100 m).

The two LEDs `RUN` and `ERR` indicate that the connection was successful and is active.

The measuring device can be configured via SDOs (EtherCAT), the web interface or by ASCII commands at command level (e.g. Telnet).

4.3.10 Analog Output

The alternative analog output (voltage or current) is connected to the 17-pin connector and is galvanically connected to the supply voltage.

IFC2411, 17-pin connector		SC2415-x/OE
Signal	Pin	Wire color
Analog output	1	White, inside
Analog GND	2	Black ¹
Shield	Housing	Black

Voltage: Pin V_{out} and Pin GND,

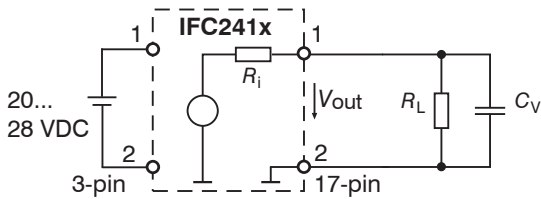

R_i approx. 50 Ohm, $R_L > 10$ MOhm

Slew rate (without C_V , $R_L \geq 1$ kOhm) typ. 0.5 V/ μ s

Slew rate (with $C_V = 10$ nF, $R_L \geq 1$ kOhm) typ. 0.4 V/ μ s

Current: Pin I_{out} and Pin GND

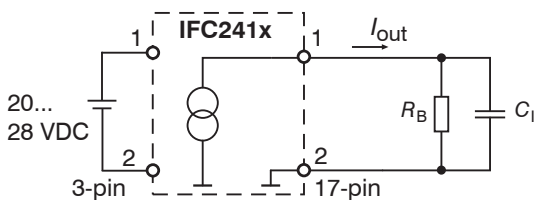

$R_B \leq 500$ Ohm

Slew rate (without C_I , $R_B = 500$ Ohm) typ. 1.6 mA/ μ s

Slew rate (with $C_I = 10$ nF, $R_B = 500$ Ohm) typ. 0.6 mA/ μ s

► Use a shielded cable. Cable length less than 30 m.

As an alternative, the output range can be set to the following values:

Voltage: 0 ... 5 V; 0 ... 10 V;

Current: 4 ... 20 mA.

The measured values can only be output as voltage or current.

1) Analog output in shielded cable area

4.3.11 Multifunction Input

A switching transistor with an open collector (e.g. in an optocoupler), a relay contact or a digital TTL or HTL signal are suitable for switching.

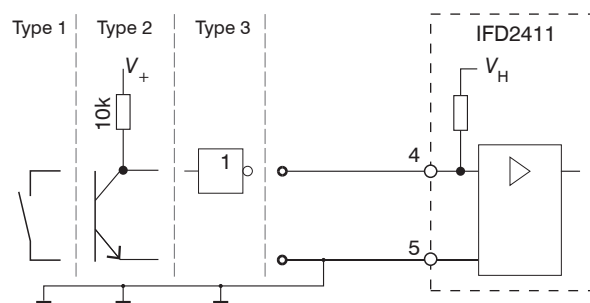

24V logic (HTL): Low ≤ 3 V; High ≥ 8 V (max 30 V),

5V logic (TTL): Low ≤ 0.8 V; High ≥ 2 V

Minimal pulse width 50 μ s

Internal pull-up resistor, an open input is detected as High.

Maximum switching frequency 25 kHz

An external resistor is not required for current limitation. The ground of the logic circuit must be galvanically connected to the supply ground.

4.3.12 Synchronization (Inputs/Outputs)

4.3.12.1 General

- The SYNC+ and Sync- pins on the 5-pin clamping sleeve: Symmetrical output/input for synchronization of two or more controllers
- The pin multifunction input 1 on the 5-pin clamping sleeve: Input for synchronization of a controller with an external synchronization source, such as a function generator
- The termination resistor R_T (120 Ohm) can be switched on or off via software.

4.3.12.2 Internal Synchronization

One IFC2411 controller (master) synchronizes one or more controllers (slaves).

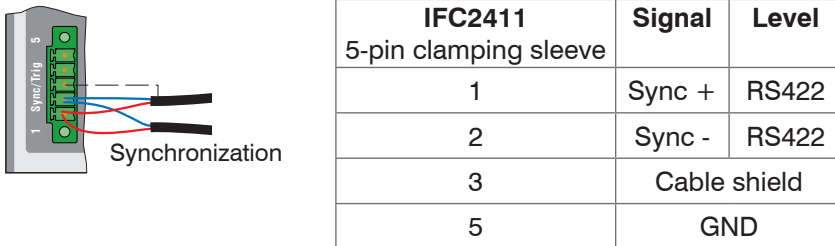

Fig. 26 Connections and signal level internal synchronization

- ▶ Activate the termination resistor (120 Ohm) in the last controller (slave n) in the chain.

Star synchronization

- ▶ Connect pins Sync+ and Sync- from controller 1 (master) in a star shape to pins Sync+ and Sync- from controller 2 (slave) to controller n, in order to synchronize two or more controller to one another, see Fig. 27
- Sub-loop length less than 30 m in star synchronization

Chain synchronization

- ▶ Connect pins Sync+ and Sync- from controller 1 (master) to pins Sync+ and Sync- from controller 2 (slave 1). Connect the pins of the following controller to synchronize two or more controller to one another, see Fig. 27
- Total line length less than 30 m in chain synchronization

- ▶ Use shielded cables with twisted wires.
- ▶ Connect the cable shield to pin 3 of the 5-pin terminal block.
- ▶ Program controller 1 to Master and all other controller to Slave.



Fig. 27 Synchronization of multiple controllers, star-shaped on the left, daisy-chained on the right

- ▶ Connect all GND connections of the supply to one another if the controllers are not fed by a common power supply.
- ⓘ If the sensors are operated by way of the EtherCAT interface, then synchronization can also be achieved without the synchronization line.

4.3.12.3 External Synchronization Controller

An external synchronous source synchronizes one or more controller (slaves).

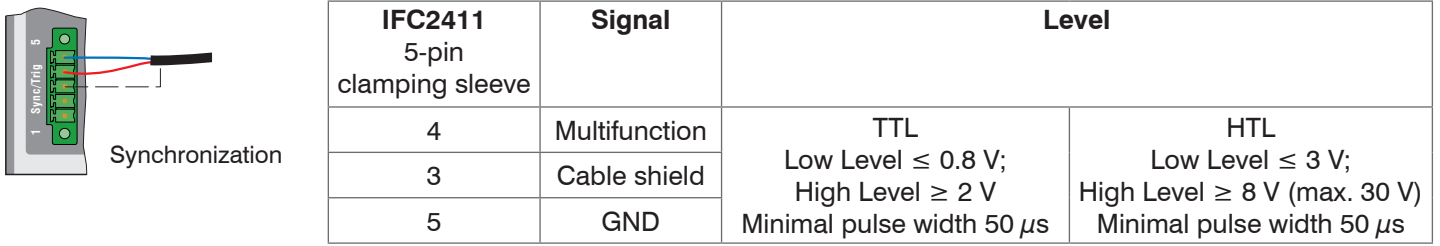

Fig. 28 Connections and signal level external synchronization

- ▶ Activate the termination resistor (120 Ohm) in the last controller (slave n) in the chain.

Star synchronization

- ▶ Connect the multifunction pin of slave 1 to the external synchronization source.
- ▶ Connect the GND of the controller to the ground connection of the synchronization source.

Further controllers can be synchronized in the same schematic.

- Sub-loop length less than 30 m in star synchronization
- ▶ Use shielded cables with twisted wires.
- ▶ Connect the cable shield to pin 3 of the 5-pin terminal block.
- ▶ Program all controllers to Slave.



Fig. 29 Synchronization of multiple controllers, star-shaped

- ▶ Connect all GND connections of the supply to one another if the controllers are not fed by a common power supply.
- i** If the controllers are operated by way of the EtherCAT interface, then synchronization can also be achieved without the synchronization line.

4.3.13 Triggering

4.3.13.1 General

Data recording or output can be triggered with:

- the multifunction input,
- synchronization inputs Sync+ and Sync-,
- encoder 1.

➤ Use a shielded cable with twisted wires. Cable length less than 30 m.

Switching contacts, transistors (NPN, N-channel FET) or PLC outputs can be used as trigger sources.

4.3.13.2 Triggering with Multifunction Input

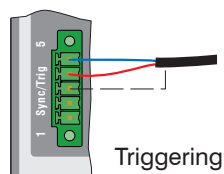

IFC2411 5-pin clamping sleeve	Signal	Level	
4	Multifunction	TTL Low Level $\leq 0.8\text{ V}$; High Level $\geq 2\text{ V}$ Minimal pulse width $50\ \mu\text{s}$	HTL Low Level $\leq 3\text{ V}$; High Level $\geq 8\text{ V}$ (max. 30 V) Minimal pulse width $50\ \mu\text{s}$
3	Cable shield		
5	GND		

➤ Connect the multifunction pin to the external trigger source.

➤ Connect the GND of the controller to the ground connection of the external trigger source.

➤ Connect the trigger cable shielding to pin 3.

Program the controller's multifunction connection to the trigger input function.

4.3.13.3 Triggering with Synchronization Input

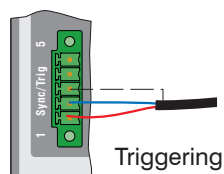

IFC2411 5-pin clamping sleeve	Signal	Level
1	Sync +	RS422
2	Sync -	RS422
3	Cable shield	

➤ Connect pin 1 (Sync+) and pin 2 (Sync-) to the external trigger source.

➤ Connect the trigger cable shielding to pin 3.

Program the controller's multifunction connection to the trigger input function.

➤ Connect pins Sync+ and Sync- to the external trigger source.

Program the sensor's sync connections to the trigger input function.

The trigger source (master) must supply a symmetrical output signal according to the RS422 standard. For asymmetrical trigger sources, Micro-Epsilon recommends inserting the SU4 level converter (3 channels TTL/HTL to RS422) between trigger signal source and sensor.

4.3.13.4 Triggering with Input Encoder 1

A connected encoder at the input of encoder 1 can be used for triggering.

IFC2411, 17-pin connector			SC2415-x/OE
Signal	Pin	Level	Wire color
Encoder 1B+	8	RS422 (EIA422)	Gray
Encoder 1B-	15		Pink
Encoder 1A-	12		Red/blue
Encoder 1A+	17		Gray/pink

Program the controller's encoder connections to the trigger input function.

4.3.14 Encoder Input

The measuring system supports one encoder.

Encoder inputs:

- Incremental signals A, B
- Reference pulse

The maximum pulse frequency is 1 MHz.

RS422 level (symmetrical) for A, B, Ref

The encoder supply is not provided.

Sensor, 17-pin connector		SC2415-x/OE
Signal	Pin	Wire color
Encoder 1B+	8	Gray
Encoder 1B-	15	Pink
Encoder 1Ref+	9	Green
Encoder 1Ref-	16	Yellow
Encoder 1A-	12	Red/blue
Encoder 1A+	17	Gray/pink

Fig. 30 Pin assignment for encoder input

➤ Use a shielded cable. Cable length shorter than 3 m. Connect the cable shield to the housing.

Connection conditions

- The encoders must supply signals with TTL level. .

4.3.15 Handling of the Plug-In Screw Terminals

The controller has two plug-in screw terminals for supply, synchronization and triggering. These are included as accessories.

➤ Remove the insulation of the connection wires (0.14 ... 1.5 mm²) over a length of 7 mm.

➤ Connect the connection wires.

• The screw terminals can be fastened with two captured screws.

4.3.16 Dark Correction IFD2415

A dark correction must be carried out after the sensor or sensor cable is changed. Find the details on this in the Commissioning see Chap. 5 section.

4.4 LEDs

LED	Color	Status	Meaning
Intensity	Red	flashes	Dark signal acquisition in progress
	Red	illuminated	Signal saturated
	Yellow	illuminated	Signal too low
	Green	illuminated	Signal OK
Range	Red	flashes	Dark signal acquisition in progress
	Red	illuminated	No target present, outside of measuring range
	Yellow	illuminated	Target close to mid of measuring range
	Green	illuminated	Target within the measuring range
RUN	Green	Off	Slave is in "Init" status
	Green	flashes uniformly	Slave is in "Pre-Operational" status
	Green	flashes briefly	Slave is in "Safe-Operational" status
	Green	flashes rapidly	Slave is in "Initialization" or "Bootstrap" status
	Green	illuminated	Slave is in "Operational" status
ERR	Red	Off	no error
	Red	flashes uniformly	invalid configuration
	Red	flashes briefly	Unintentional change in status
	Red	flashes twice	Application watchdog timeout
	Red	flickers	Boot error
	Red	illuminated	PDI watchdog timeout



Fig. 31 Meaning of LEDs on measuring system

4.5 Correct and Multifunction Key

The Correct keys on the IFD241x or Multifunction keys on the IFC2411 are assigned for multiple functions. The key is assigned the dark correction function from the factory.

Function	Dark correction	<i>Dark correction starts</i>
	Factory settings	Resets the device and measurement settings to factory settings.

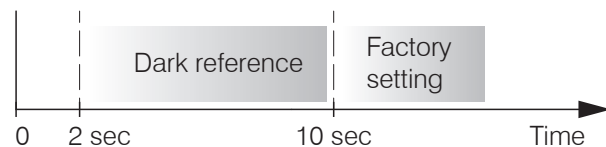

Fig. 32 Correct key actuation time

The key is not assigned a key lock from the factory. You can optionally deactivate or lock the key to prevent incorrect operation.

The key can also be used to switch the operating mode. You can find more details on this in the section Commissioning or Switch between EtherCAT and Ethernet Setup Mode, see Chap. A 6.

Set to factory setting: Hold the key for longer than 10 s.

5. Commissioning

5.1 Communication Options

- The measuring system is ready for operation approx. 3 s after the supply voltage is applied.
- ! To ensure precise measurements, let the measuring system warm up for approx. 50 minutes.

The measuring system starts with the last saved operating mode. EtherCAT is standard.

	Standard		Alternative Communication
EtherCAT	Ethernet over EtherCAT (EoE)	Ethernet Setup Mode	RS422 Communication
<ul style="list-style-type: none"> ➔ Integrate the device description file (EtherCAT® slave information) into your PLC development environment, e.g. TwinCAT: <ul style="list-style-type: none"> - Micro-Epsilon_IFC241x.xml for IFD2411 - Micro-Epsilon_IFD241x.xml for IFD2410/2415 <p>You can find these online at:</p> <ul style="list-style-type: none"> - https://www.micro-epsilon.de/download/software. <p>Further information for EtherCAT operation can be found here, see Chap. 8.</p>	<ul style="list-style-type: none"> - Programming via web interface, - Programming at command level, e.g. via Telnet, - Parallel parameterization and measurement <ul style="list-style-type: none"> ➔ Activate EoE in your PLC software. <p>Virtual Ethernet Port is a name in TwinCAT®.</p> <ul style="list-style-type: none"> ➔ Assign a MAC address and an IP address to the slave. ➔ Continue with chapter Access via Web Interface. 	<ul style="list-style-type: none"> - Programming via web interface, - no EtherCAT <ul style="list-style-type: none"> ➔ Switch to the Ethernet setup mode. <p>You can find more details on this in the section <code>Switch between EtherCAT and Ethernet Setup Mode</code>.</p> <ul style="list-style-type: none"> ➔ Connect the measuring system and PC with a LAN cable. ➔ Start your web browser and type the standard IP address of the sensor 169.254.168.150 into the address bar. ➔ Continue with chapter Access via Web Interface. 	<ul style="list-style-type: none"> - Programming via web interface, - Programming at command level, e.g. via Telnet, - Parallel output of measurement data not possible via EtherCAT and RS422 <ul style="list-style-type: none"> ➔ Connect the measuring system to a PC e.g. via an RS422 converter IF2001/USB from Micro-Epsilon via USB. ➔ Start the <code>sensorTOOL</code> program. <p>Download at https://www.micro-epsilon.de/download/software/sensorTOOL.exe.</p> <ul style="list-style-type: none"> ➔ Click the <code>sensor</code> button. <p>The program searches for connected measuring systems.</p> <ul style="list-style-type: none"> ➔ Select the desired measuring system. Click on the <code>Open website</code> button.

Saved settings remain residually in the measuring system and across interfaces.

5.2 Access via Web Interface

➡ Launch the web interface of the measuring system, see [Chap. 5.1](#).

Interactive web pages for configuring the measuring system now appear in the web browser. The measuring system is active and provides measured values. Real-time measurement with the web interface is not guaranteed. The ongoing measurement can be controlled with the function buttons in the `chart` type.

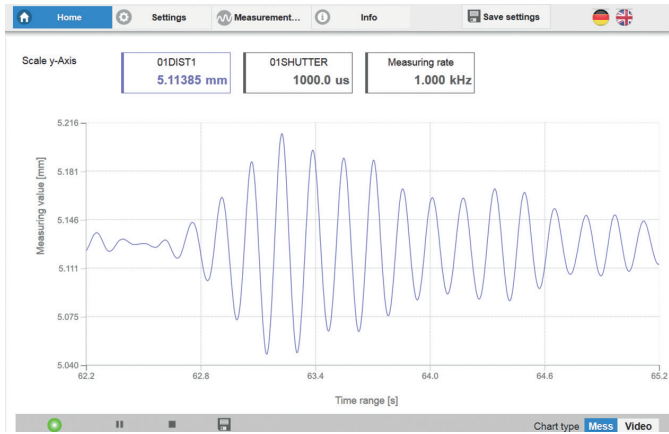

Fig. 33 Start page after accessing the web interface in Ethernet mode

You can switch between the video signal and a display of the measured values over time for configuration. The appearance of the web sites can change depending on the functions. Dynamic help texts with excerpts from the operating instructions aid you in configuring the measuring system.

i Depending on the selected measuring rate and the PC used, there may be a dynamic reduction of the measured value in the display. This means that not all measured values are sent to the webinterface for display and saving.

The horizontal navigation contains the following functions:

- Home. The web interface automatically starts in this view with measurement chart, measurement configuration and signal quality.
- Settings. Configuration parameters, including triggering, measuring rate and zeroing/mastering.
- Measurement chart. Measurement chart or show video signal.
- Info. Contains information on the sensor, including measuring range, serial number and software version.
- Web interface language selection

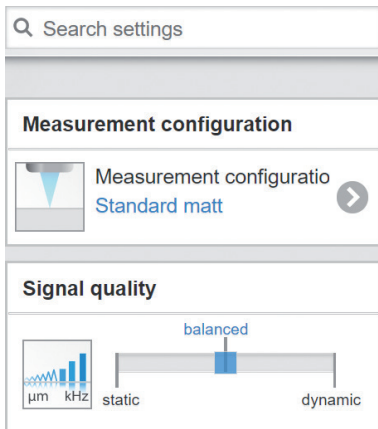

The vertical navigation is related to the context of the selection in the horizontal navigation and contains the following functions for the Home menu:

- The Find settings function enables time-saving access to functions and parameters.
- Measurement configuration. Enables selection of predefined measurement settings.
- Signal quality. You can switch between three predefined basic settings for the measuring rate and averaging with a mouse click.

5.3 Positioning the Target

➡ Position the target as centrally as possible within the measuring range.

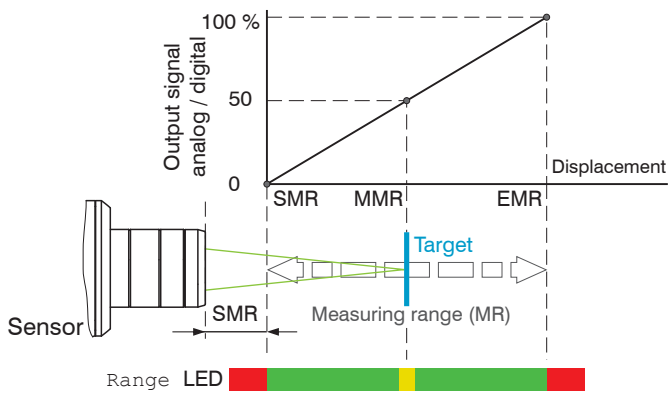

- intensity
- range

LED Range	
Red	No target present or target outside of measuring range
Yellow	Target close to mid of measuring range
Green	Target within the measuring range

The Range LED on the front of the measuring system indicates the position of the target relative to the sensor.

5.4 Select Sensor

The function is valid for the IFD2411 measuring system.

Controller and sensor(s) are coordinated to one another at the factory.

➡ Go to the Settings > Sensor menu.

➡ Select the required sensor from the list.

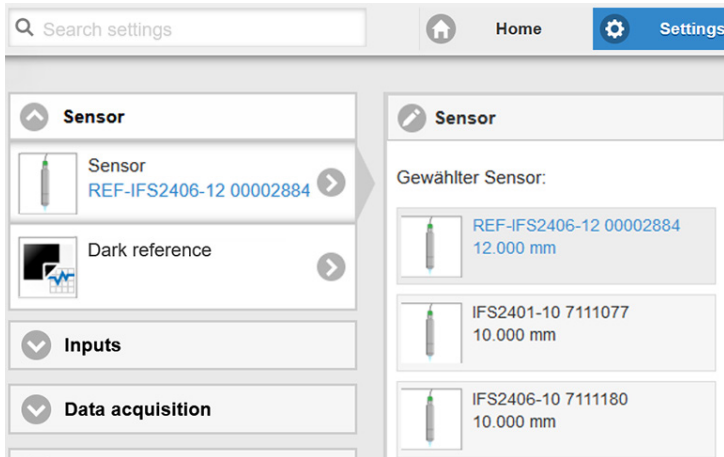

The calibration data of up to 20 different sensors can be saved in the controller. Calibration is only possible at Micro-Epsilon.

5.5 Presets, Setups, Measurement Configuration Selection

Definition

- Preset: Manufacturer-specific program containing settings for common measuring tasks that cannot be overwritten
- Setup: User-specific program containing the relevant settings for a measuring task
- Initial setup upon boot-up (start measuring system): a favorite setting which is automatically activated upon start-up can be selected from the setups. If no favorite is selected from the setups, the measuring system activates the Standard preset upon start-up.

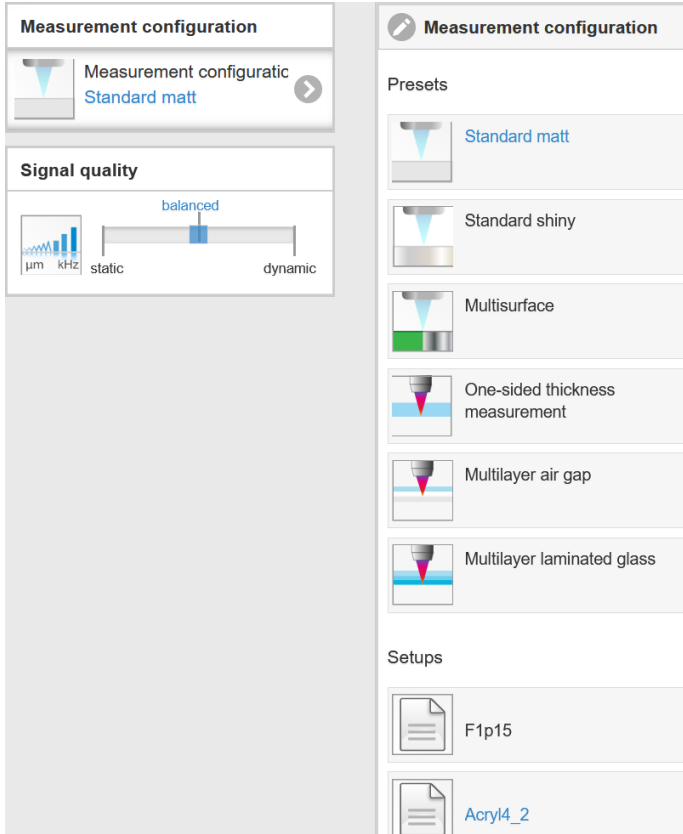

Upon delivery of the measuring system from the factory:

- the presets Standard, Standard shiny, Multisurface and One-sided thickness measurement are available
- for the IFD2415 sensor, the presets Multilayer airgap and Multilayer laminated glass are additionally available,
- no setup is present.

You can select a preset in the tab

Home > Measurement configuration

You can select a setup in the tab

Home > Measurement configuration or

Settings in menu System Settings > Load & Save

A setup can be permanently saved in the measuring system.

These presets allow for a quick start in the individual measuring task. Basic features to suit the target surface, such as peak and material selection and the calculation functions are already set in the preset.

	Standard matt	Distance measurement e.g. for ceramic material, non-transparent plastics. Highest peak, averaging, distance calculation.
	Standard shiny	Distance measurement e.g. for metal, polished surfaces. Highest peak, median over 5 values, distance calculation.
	Multisurface	Distance measurement e.g. for PCBs, hybrid materials. Highest peak, median over 9 values, distance calculation.

	One-sided thickness measurement	One-sided thickness measurement e.g. against glass, material BK7. First and second peak, averaging, thickness calculation.
	Multilayer air gap	One-sided thickness measurement ¹ against glass, 1st layer BK7, 2nd layer vacuum, first and second peak, 3 measured values, median over five values, moving averaging over 16 values, thickness calculation.
	Multilayer laminated glass	Layer thickness measurement ¹ against laminated glass e.g. windshield, 1st layer BK7, 2nd layer PC, 3rd layer BK7, first and second peak, 4 measured values, thickness calculation, moving averaging over 16 values.

1) Possible in IFD2415.

5.6 Video Signal

➡ Go to the `Measurement` chart menu. Show video signal display with `Video`.

The diagram in the large graphic window on the right shows the video signal of the receiver line in different post-processing states.

The video signal in the graphics window shows the spectral distribution over the pixels of the receiver line. Left 0 % (small distance) and right 100 % (large distance). The corresponding measured value is marked by a vertical line (peak marking).

The diagram starts automatically when the website is accessed.

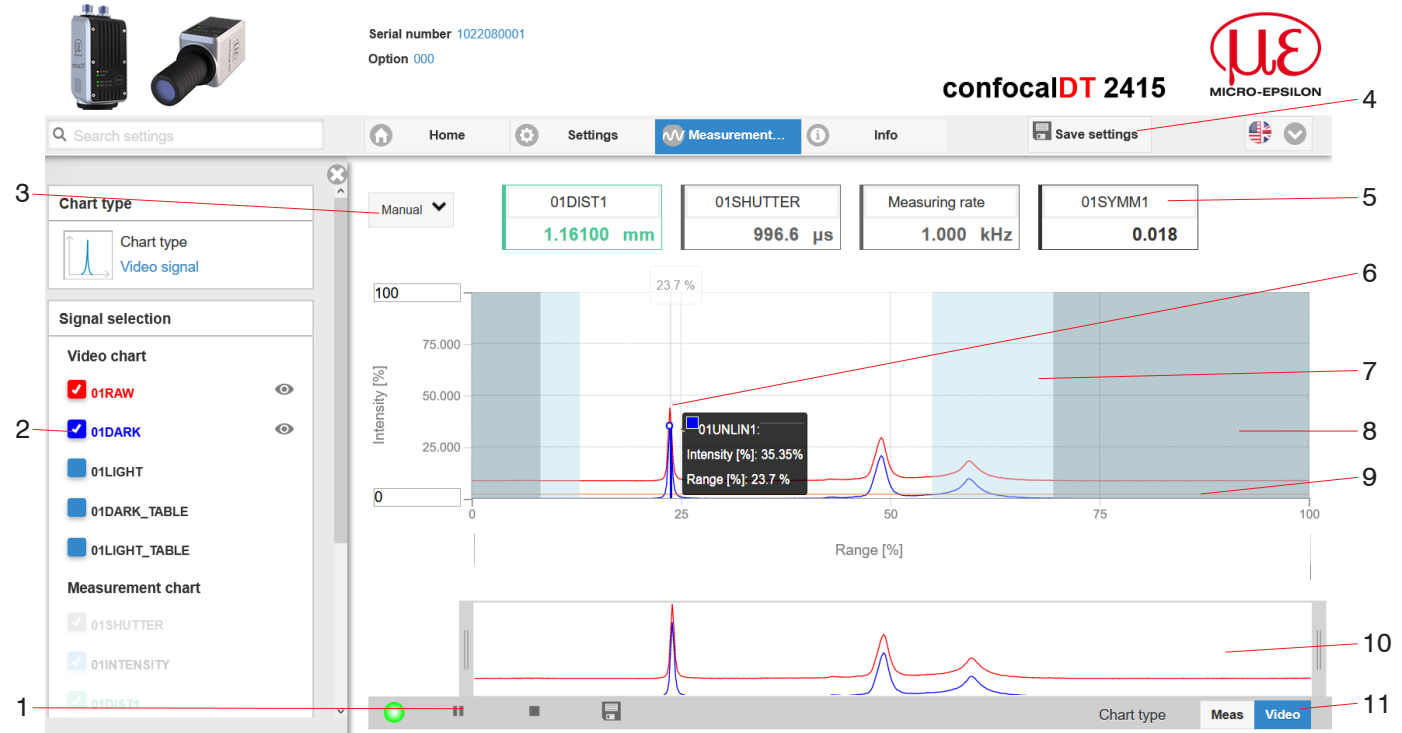

Fig. 34 Video signal website

The Video Signal website contains the following functions:

- 1 The LED visualizes the state of measurement value transmission.
 - green: measured value transmission in progress
 - yellow: waiting for data in trigger state
 - gray: measured value transmission paused

The data query is controlled with the `Play/Pause/Stop/Save` buttons of the measured values transmitted. `Stop` stops the diagram; you can still continue to use the data selection and zoom functions. `Pause` pauses the recording. `Save` opens the Windows selection dialog for the file name and the save location to save the selected video signals to a CSV file. This contains all pixels, their (selected) intensity in % and other parameters.

➡ Click on the button ▶ (Start), display the measurement results.

- 2 In the left-hand window, the video curves to be displayed can be switched on or off during or after the measurement. Inactive curves are grayed out and can be added by clicking on the check mark. The changes become effective when you save the settings.

You can show or hide the individual signals using the eye symbols . The calculation continues in the background.

- 0xRAW: Raw signal (uncorrected CCD signal)
- 0xDARK: Dark corrected signal (raw signal minus dark level table)
- 0xLIGHT: Light corrected signal (dark corrected signal corrected with the light source table)
- 0xDARK_TABLE: Dark value table (generated in response to dark referencing)
- 0xLIGHT_TABLE: Light value table (generated in response to light referencing)

- 3 To scale the intensity axis in the graph for the measured values (Y axis), you can use `Auto` (= automatic scaling) or `Manual` (= manual scaling).
- 4 All changes only become effective when you click on the `Save settings` button.

- 5 The current values, such as exposure time and selected measuring rate, are additionally displayed above the graphic.
- 6 Mouseover function. Moving the mouse over the graph, marks curve points or the peak marking with a circle symbol and displays the corresponding intensity. The corresponding x-position in % appears above the graph field.
- 7 The range of interest can be restricted if ambient light of a certain wavelength (blue, red, IR) causes interference in the video signal, for example. The value for the “Start of range” must be less than the value for the “End of range”. Value range between 0 and 100 %.
- 8 The linearized range lies between the gray shades in the diagram and cannot be changed. Only peaks whose mid-dles lie within this range can be calculated as a measured value. The masked area can be restricted if necessary and is then limited by an additional light blue shading on the right and left. The peaks remaining in the resulting range are used for the evaluation.
- 9 The detection threshold, in relation to the dark corrected signal, is a horizontal straight line corresponding to the preselected value. It should be just high enough so that no unwanted peaks in the video signal are included in the evaluation. Aim for the lowest possible threshold to get a good signal-to-noise ratio. The detection threshold should not be changed if possible.
- 10 X axis scaling: The diagram shown above can be enlarged (zoomed in on) with the two sliders on the right and left in the lower entire signal. It can also be moved sideways with the mouse in the middle of the zoom window (four-sided arrow).

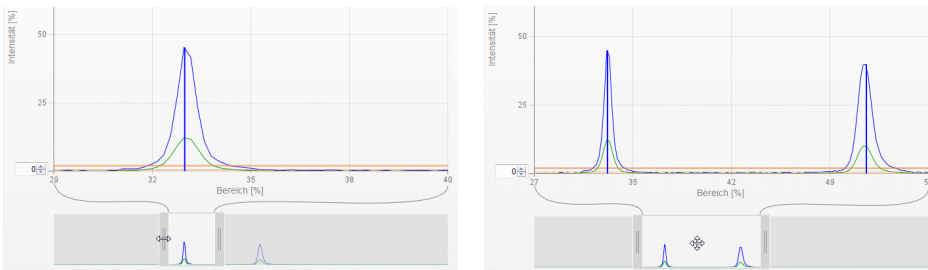

Fig. 35 Zooming with slider: one-sided or shifting range with four-sided arrow

- 11 The two buttons allow you to switch between the display of the video signal and the measured value.

5.7 Signal Quality

A good measurement result can be achieved if the video signal is sufficiently intense. Reducing the measuring rate increases the exposure time for the CCD row and thus improves the measurement quality.

You can switch between three basic settings (Static, Balanced and Dynamic) in the Signal quality section. The reaction in the chart and system configuration is immediately visible.

➡ Go to the Home > Signal quality menu and adjust the measurement dynamics as required. Monitor the result in the video signal.

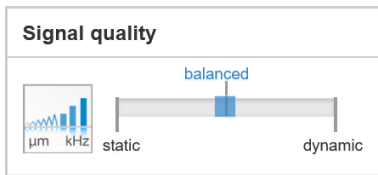

	Measuring rate	Averaging ¹
Static	200 Hz	Moving, 128 values
Balanced	1 kHz	Moving, 16 values
Dynamic	5 kHz	Moving, 4 values

i If the sensor starts up with a user-defined configuration (Setup), see [Chap. 5.5](#), the signal quality cannot be changed.

1) Applies to the presets Standard and One-sided thickness measurement.

5.8 Distance Measurement with Website Display

- ▶ Align the sensor perpendicularly to the object to be measured.
- ▶ Then, remotely, move the sensor (or the target) closer and closer until the start of the measuring range for the relevant sensor is approximately reached.

As soon as the object is within the measuring field of the sensor, this is shown by the Range LED (green or yellow). Alternatively, you can watch the video signal.

LED	Status	Description
Intensity	Red	Signal saturated
	Yellow	Signal too low
	Green	Signal OK
Range	Red	No target or target outside of measuring range
	Yellow	Target in center of measuring range
	Green	Target within the measuring range

Fig. 36 Meaning of LEDs during distance measurement

Opening Measurement Chart > Chart type Measure opens the following website. The chart starts automatically when the website is accessed. The diagram in the large graphic window on the right shows the measured value-time diagram.



Fig. 37 Measurement (distance measurement) web page

- 1 The LED visualizes the state of measured value transmission.
 - green: measured value transmission in progress
 - yellow: waiting for data in trigger state
 - gray: measured value transmission paused

The data query is controlled with the Play/Pause/Stop/Save buttons of the measured values transmitted. Stop stops the diagram; you can still continue to use the data selection and zoom functions. Pause pauses the recording. Save opens a Windows selection dialog for the file name and save location to save the last 10,000 values in a CSV file (separation using semicolon).

- ▶ Click on the button ▶ (Start), display the measurement results.

- 2 In the left-hand window, the signals of channel 1/2 to be displayed can be switched on or off during or after the measurement. Inactive curves are grayed out and can be added by clicking on the check mark. The changes become effective when you save the settings.
You can show or hide the individual signals using the eye symbols . The calculation continues in the background.
 - 0xSHUTTER: Exposure time
 - 0xINTENSITY: Signal quality of the underlying peak in the video signal
 - 0xDIST: Distance signal curve over time
- 3 To scale the axis in the graph for the measured values (Y axis), you can use `Auto` (= automatic scaling) or `Manual` (= manual scaling).
- 4 All changes only become effective when you click on the `Save settings` button.
- 5 Current values for distance, exposure time, current measuring rate and time stamp are shown in the text boxes above the graph. Errors are also displayed.
- 6 Mouseover function. When the chart has been stopped and you move the mouse over the graph, points on the curve are marked with a circle and the associated values are displayed in the text boxes above the graph. The intensity bars are also updated.
- 7 Peak intensity is displayed as a bar chart.
- 8 X axis scaling: During an ongoing measurement, you can use the left-hand slider to enlarge the entire signal (zoom). The time range can also be defined using an input field under the time axis. When the chart has been stopped, the right-hand slider can also be used. You can also move the zoom window with the mouse in the center of the zoom window (four-sided arrow).

5.9 Save/Load Settings

This menu enables you to save current device settings in the controller or activate saved settings. You can permanently save eight different parameter sets in the controller.

Unsaved settings will be lost when the device is switched off. Save your settings in Setup.

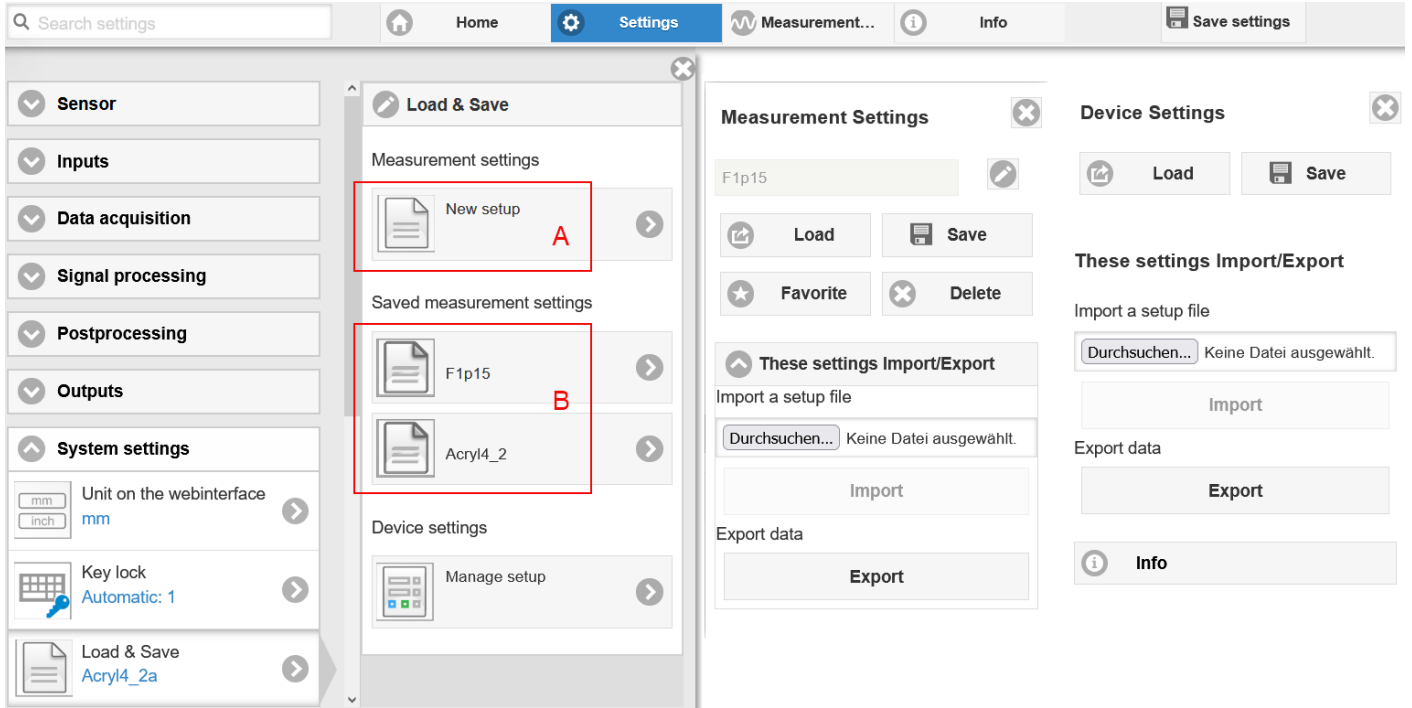

Fig. 38 Manage user programs

➡ Switch to the Settings > Load & Save menu.

Manage setups in the controller, options and sequence			
Saving the Settings	Existing setup active	Save change in active setup	Determine setup after booting
Menu New Setup, Range A	Menu Load & Save	Menu bar	Menu Load & Save
➡ Enter the name for the setup in the Individual setup name field, such as F1p15, and confirm the entry with the Save button.	➡ Click on the desired setup with the left mouse button, area B. The Measurement Settings dialog will open. ➡ Click on the Load button.	➡ Click on the Save settings button.	➡ Click on the desired setup with the left mouse button, area B. The Measurement Settings dialog will open. ➡ Click on the Favorite button.

The current settings will also be available in the controller after it has been switched off/on.

You can also use the Save Settings button at top right, in each settings page as quick cache for the last parameter set saved.

i The last parameter set saved in the controller is loaded when switched on.

Switch setups with PC/notebook, options	
Save setup on PC	Load setup from PC
Menu Load & Save	Menu Load & Save
<p>➤ Click on the desired setup with the left mouse button, area B.</p> <p>The Measurement Settings dialog will open.</p> <p>➤ Click on the Export button.</p>	<p>➤ Click on Create setup with the left mouse button.</p> <p>The Measurement Settings dialog will open.</p> <p>➤ Click on the Search button.</p> <p>A Windows dialogue for file selection opens.</p> <p>➤ Select the desired file and click the Open button.</p> <p>➤ Click on the IMPORT button.</p>

5.10 Dark Correction

The measuring system requires a warm-up time of approx. 30 min. before performing dark correction.

A dark correction is required after:

- Replacing a sensor
- Replacing a sensor cable
- Prolonged operating period, sensor getting dirty

The dark correction depends on the sensor and is saved separately in the controller for each measuring system. For that reason, the desired sensor must be connected before correction. For the IFD2411, the sensor must be selected in the **Settings > Sensor** menu.

Work steps:

➡ Remove the target from the measuring range or cover the sensor front with a piece of dark paper.

I During the dark correction, there must be no objects within the measuring range nor ambient light reaching the sensor under any circumstances.

Correction with key function		Correction via software/web interface
IFD2410/2415	IFD2411	
➡ Press the Correct key on the IFD2410/2415 for approx. 4 s ¹ in order to start the correction.	➡ Press the multifunction key on the IFD2411 for approx. 4 s in order to start the correction.	➡ Switch to the Settings > Sensor > Dark correction menu. ➡ Click on the Start button to start the correction.

The LEDs *Intensity* and *Range* start to flash. The sensor now records the current dark signal for about 50 s.

The dark corrected video signal after the adjustment is characterized by a signal curve that is an almost smooth directly at the X axis.

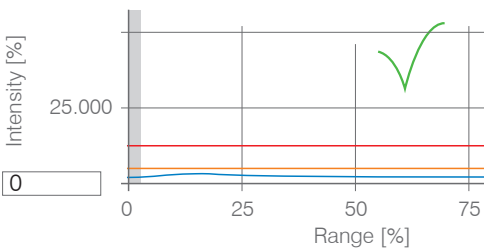
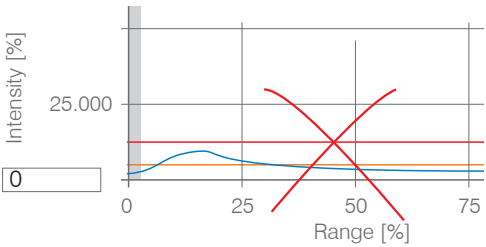
IFD2410/2415	Dark signal evaluation	IFD2411
➡ Remove the paper cover from the sensor. This sensor can be used normally again.	 <p style="text-align: center;">Dark signal OK</p>	➡ Remove the paper cover from the sensor. This sensor can be used normally again.
➡ Carefully clean the glass surface on the sensor. ➡ Repeat the dark correction.	 <p style="text-align: center;">Dark signal too high</p>	➡ Carefully clean the front surface of the E2000 connector of the sensor cable. ➡ Repeat the dark correction.

With each new dark correction, the current brightness value is determined as the quotient of the sum of all intensities and the current exposure time. If a major change is detected from the previously saved value, this can be interpreted as a degree of contamination and a warning is given.

You can also ignore this message. For time-critical measurements, however, you should remember the current exposure time.

1) If the key is pressed for more than 10 seconds, the factory setting is loaded.

Exclusively use pure alcohol and fresh lens cleaning paper for cleaning.

If cleaning the components does not have the desired result, the sensor cable may also have been damaged or the fiber connector in the controller may have become dirty.

Replace the sensor cable or send the entire system in for inspection.

You can use an ASCII command to set the warning threshold for contamination if required

- permissible deviation in %,
- the factory setting is 50 %.

The warning threshold is saved so that it is specific to the setup.

6. Set Sensor Parameters, Web Interface

6.1 Inputs

6.1.1 Synchronization

➡ Switch to the **Settings** tab in the **Inputs** menu.

Synchronization	<i>Master / Slave / Multifunction input 1 / Multifunction input 2</i>	<i>If multiple measuring systems are to measure the same target at the same time, the controllers can be synchronized with one another. The synchronization output of the first controller (master) controls the controllers (slaves) connected at the synchronization inputs, see Chap. 4.2.11, see Chap. 4.3.12.</i>
	<i>Inactive</i>	

If the controllers are operated by way of an EtherCAT interface, then synchronization can also be achieved without the synchronization line. You can find more details on this in the Distributed Clocks section, see [Chap. 8.8.2](#).

6.1.2 Encoder Inputs

6.1.2.1 Overview, Menu

The IFD2410/2415 supports up to three encoders, see [Chap. 4.2.13](#).

The IFD2411 supports one encoder, see [Chap. 4.3.14](#).

A maximum of three encoder values can be assigned to the measuring data exactly, output and also used as triggering condition. This exact assignment to the measured values is ensured by the fact that precisely those encoder values are output that were present in half of the exposure time of the measured value (the exposure time can vary due to the regulation). Tracks A and B enable direction recognition. Each of the encoders can be set separately.

<i>Number of Encoders</i>	<i>1 / 2 / 3</i>	
<i>Encoder 1 / 2</i>	Interpolation	<i>single / double / quadruple resolution</i>
	Maximum Value	<i>Value</i>
	Effect on Reference Track	<i>no effect / set once for mark / set for all marks</i>
	Set to Value	<i>Value</i>
	Set encoder value via software	
	Reset the detection of the first reference mark	
<i>Encoder 3</i>	Interpolation	<i>single / double / quadruple resolution</i>
	Maximum Value	<i>Value</i>
	Effect on Reference Track	<i>no effect</i>
	Set to Value	<i>Value</i>
	Set encoder value via software	
	Reset the detection of the first reference mark	

6.1.2.2 Number of Encoders

The number of encoders determines how many of the encoders are used. With 2 encoders, data output via RS422 and synchronization cannot be used. With 3 encoders, the reference tracks of encoder 1 and encoder 2 cannot be used.

6.1.2.3 Interpolation

Interpolation increases the resolution of an encoder. The counter reading is incremented or decremented with each interpolated pulse edge.

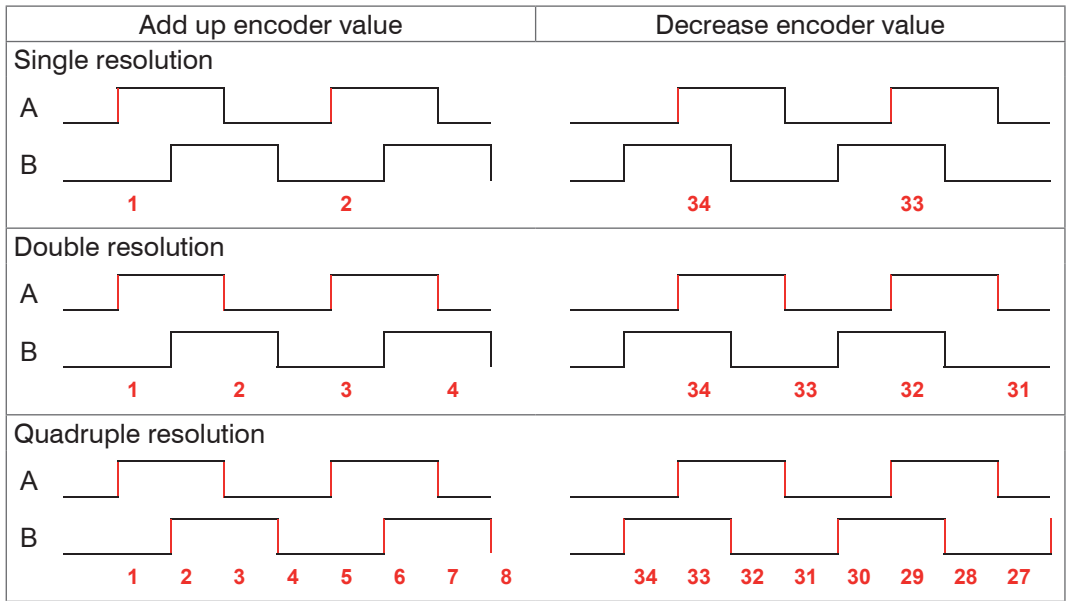

Fig. 39 Pulse image encoder signals

6.1.2.4 Maximum Value

If the encoder exceeds this maximum value, the encoder counter restarts the count at zero. This could be the pulse count of an encoder without zero pulse (reference track). The maximum counter reading before an overflow is 4,294,967,295 ($2^{32}-1$).

6.1.2.5 Effect of Reference Track

No effect. The encoder counter keeps on counting; the resetting takes place when the controller is switched on or when the Set to value button is pressed.

One-time setting to value at marker. Sets the encoder counter to the defined value when the first reference marker is reached. The first mark after the controller is switched on applies; without it being switching off, the marker only applies after pressing the Use next marker button.

Set for all marks. Sets the encoder counter to the starting value for all marks or when the marker is reached again, e.g. for traversing movements.

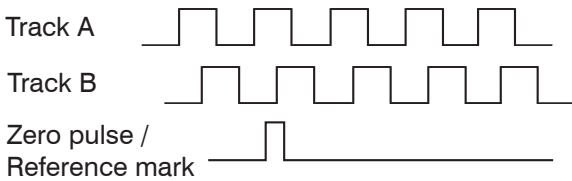

Fig. 40 Reference signal of an encoder

6.1.2.6 Set to Value

This function sets the encoders to this value

- every time the controller is switched on,
- with the Set to value button.

The start value must be less than the maximum value and is max. 4,294,967,294 ($2^{32}-2$).

6.1.2.7 Reset Reference Marker

Resets the reference marker detection.

6.1.3 Level Function Inputs

The level must be selected for the inputs:

- Synchronization
- Multifunction

Input level	TTL / HTL	<p><i>Defines the input level for the input stages.</i></p> <p><i>TTL: Low ≤ 0.8 V, High ≥ 2 V</i></p> <p><i>HTL: Low ≤ 3 V; High ≥ 8 V</i></p>
-------------	-----------	---

6.1.4 Terminating Resistor

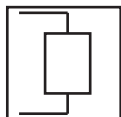

The terminating resistor at the Sync/Trig synchronization input is switched on or off to avoid reflections.

On: With terminating resistor

Off: No terminating resistor

The terminating resistor with 120 Ohm must be activated in the last slave.

6.2 Data Recording

6.2.1 Measuring Rate

IFD2410/2411: The measuring rate can be set continuously in a range from 0.1 kHz to 8 kHz. The increment is 1 Hz.

IFD2415: The measuring rate can be set continuously in a range from 0.1 kHz to 25 kHz. The increment is 1 Hz.

The selection of the measuring rate is made in the menu `Settings > Data recording > Measuring rate`.

➤ Select the desired measuring rate.

Observing the video signal is useful for selecting the measuring rate.

Procedure:

➤ Position the target in the middle of the measuring range, see Fig. 41. Keep adjusting the measuring rate until you get a high signal intensity that is not oversaturated.

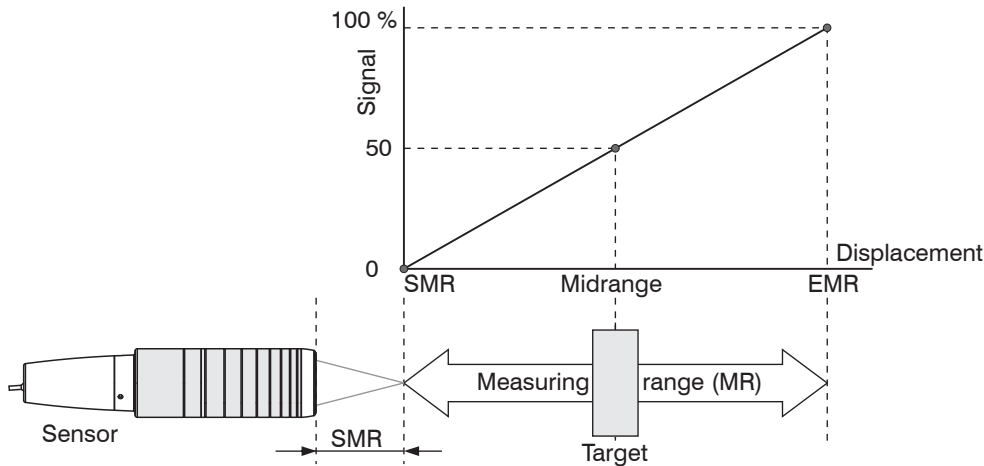

Fig. 41 Defining measuring range and output signal

➤ To do this, observe the `Intensity` LED.

LED	Status	Description
Intensity	Red	Signal saturated
	Yellow	Signal too low
	Green	Signal OK

- If the `Intensity` LED changes to red, increase the measuring rate.
- If the `Intensity` LED changes to yellow, increase the measuring rate.

➤ Choose a measuring rate that makes the `Intensity` LED light up green.

➤ If necessary, change the exposure mode, use the manual mode, see [Chap. 6.2.5](#)

➤ Use the required measuring rate, and adjust the exposure time. Or let the exposure time define possible measuring rates.

If the signal is low (`Intensity` LED is yellow) or saturated (`Intensity` LED is red), the controller will carry out measurements, but measuring accuracy might not correspond to the specified technical data.

6.2.2 Triggering Data Acquisition

6.2.2.1 General

The data recording on the confocalDT IFD241x can be controlled using an external electrical trigger signal or commands.

- The triggering does not affect the preselected measuring rate.
- Factory setting: no triggering, the controller starts with the data transmission output immediately after being switched on.
- The pulse of the trigger signal is at least $5 \mu\text{s}$.

Sync / Multifunction input 1 / 2	Trigger type	Level	Trigger level	Low / falling edge	
		Edge	Trigger level	High / increasing edge	
			Number of measured values	manual selection	Value
				infinite	
Software			Number of measured values	manual selection	Value
				infinite	
Encoder 1			Lower limit		Value
			Upper limit		Value
			Increment		Value
Inactive			Continuous data recording		

Level triggering. Continuous data recording/output as long as the selected level is present. After that, the controller stops the data recording. The pulse duration must be at least as long as one cycle. The subsequent pause must also be at least as long as one cycle.

W = Displacement signal

Fig. 42 Triggering with active high level (U_i), associated analog signal (A_o) and digital signal (D_o)

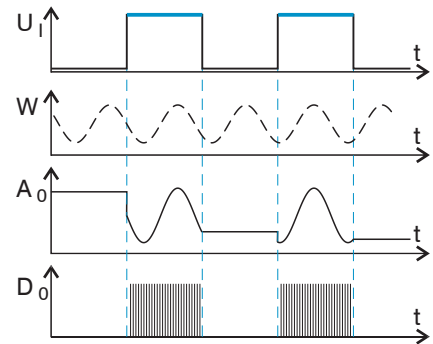

Edge triggering. Starts measured value input/output as soon as the selected edge is active to the trigger input. The pulse must be at least $5 \mu\text{s}$.

Fig. 43 Triggering with falling edge (U_i), associated analog signal (A_o) and digital signal (D_o)

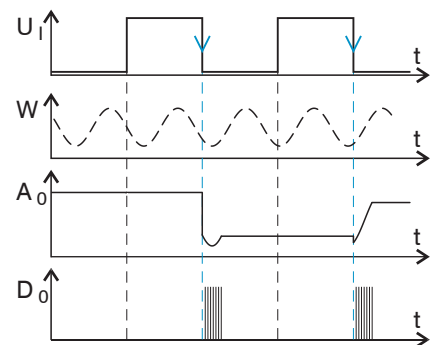

Software triggering. Starts data recording as soon as a software command (instead of the trigger input) or the Initiate trigger button is activated.

Encoder triggering. Starts the data recording through Encoder 1.

6.2.2.2 Triggering Measured Value Acquisition

The current array signal is only processed and measured values are calculated from it after a valid trigger event. The measurement data is then transferred for further calculation (e.g. averaging), as well as the output via a digital or analog interface.

When calculating averages, measured values immediately before the trigger event cannot be included; instead older measured values are used, which had been entered during previous trigger events.

Fields with gray background require a selection.

Value Fields with dark border require entry of a value.

6.2.2.3 Trigger Time Difference

Since the exposure time is not started directly by the trigger input, the respective time difference to the measurement cycle can be output. This measured value can, for example, serve to accurately assign measurements to one place, when measuring objects are scanned at a constant speed and when each track starts with a trigger pulse.

The time from the start of the cycle until the trigger event is defined as a trigger time difference. The output of the time determined occurs 3 cycles later, due to the internal processing.

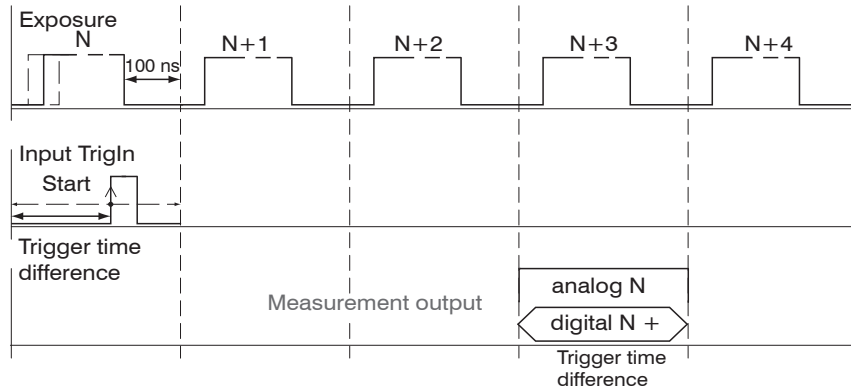

Fig. 44 Definition of the trigger time difference

The start of the cycle does not mean the start of the exposure time. There is only a fixed difference of 100 ns between the start of the cycle and the end of the exposure time.

6.2.3 Reset Counter

The measured value counter can be used to check if the data are output completely or if a package is missing. Counting begins at zero. Time stamps and measured value counter can be reset by pressing the respective button.

6.2.4 Range of Interest Masking

Masking limits the range that the video signal uses for distance or thickness calculations. This feature is used, for example, if ambient light with certain wavelengths (blue, red, IR) causes video signal interference. It is also possible to mask the background if it reaches into the measuring range.

Masking (start and end) is entered into the two boxes on the left (in %). The factory settings are 0 % (start) and 100 % (end).

If you limit the video signal area, a peak is detected only if it lies completely within the masked area, i. e. above the threshold. This can reduce the measuring range.

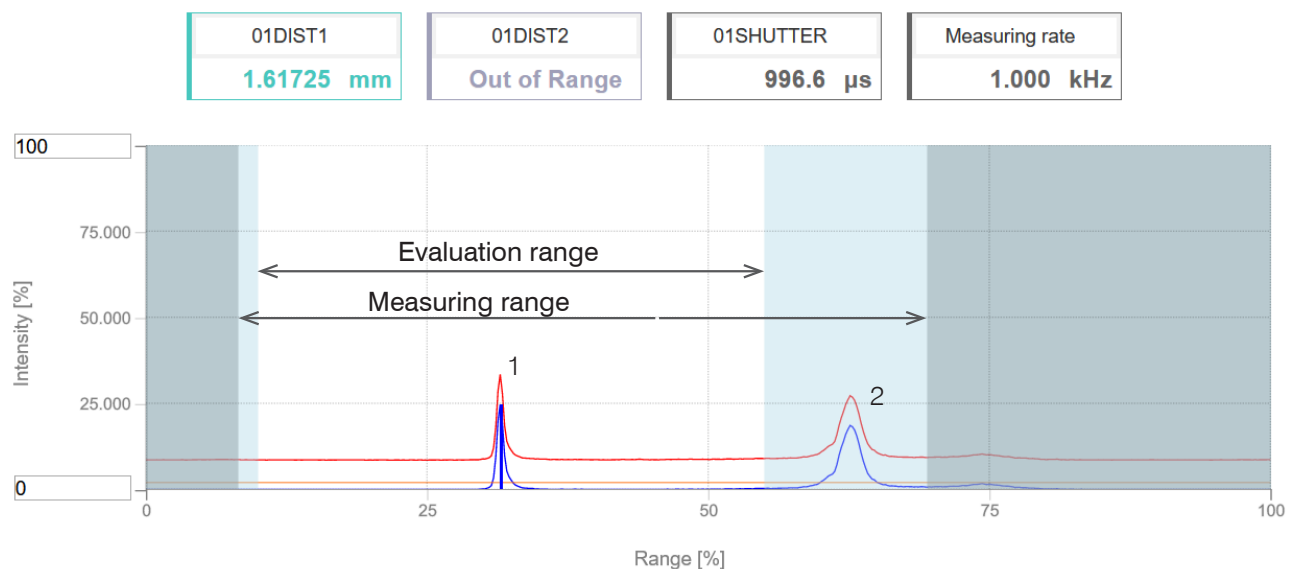

Fig. 45 Limiting the video signal used

The example shown in the figure uses peak (1) for the evaluation while peak (2) is not used.

6.2.5 Exposure Mode

<i>Measurement mode</i>		
<i>Manual mode</i>	Exposure time 1 in μs	IFD2410/2411: Value (3 μs ... 10,000 μs) IFD2415: Value (3 μs ... 10,000 μs)
<i>Alternating two-time mode</i>	Exposure time 1 in μs	IFD2410/2411: Value (1 μs ... 10,000 μs) IFD2415: Value (3 μs ... 10,000 μs)
	Exposure time 2 (shorter) in μs	Value (value is lower than exposure time 1)
<i>Automatic two-time mode</i>	Exposure time 1 in μs	IFD2410/2411: Value (1 μs ... 10,000 μs) IFD2415: Value (3 μs ... 10,000 μs)
	Exposure time 2 (shorter) in μs	Value (value is lower than exposure time 1)

➡ Select the desired exposure type.

Measurement mode. The required or appropriate measuring rate is maintained and only the exposure time is controlled. A smaller control range is used to achieve faster results. This mode also enables the user to work with targets with different reflections that have the same measuring rates. Lasts 1 up to a maximum of 7 measurement cycles (change from no target to good reflective target with 0.1 kHz measuring rate).

Manual mode. No automatic adjustments. Set optimized parameters are maintained. This makes sense for fast changes due to targets with identical surfaces moving in and out or for highly dynamic movements (no overshooting). It is not recommended to use this mode for strongly varying target surfaces. Manual mode can also be used for several layers if the brightest peak should not be captured. The video signal display can acquire suitable measuring rates and exposure times from automatic mode.

Alternating two-time mode. Operating mode with two manually preset exposure times that are always used alternately. Suitable for two very different high peaks when measuring thickness. We recommend using this mode in particular if the smaller peak disappears or the higher peak is overmodulated. Any video averaging which may be set is ignored here.

Automatic two-time mode. Fastest mode with two manually preset exposure times. The more suitable time is automatically selected. We recommend using this mode to measure distances for rapidly changing surface properties, such as mirrored or anti-glare glass.

6.2.6 Peak Separation

6.2.6.1 Peak Modulation

Peak modulation is used e.g. when measuring thin layers. A peak detected with the detection threshold may consist of two or more overlapping peaks. The peak modulation indicates to which degree the video signal must be modulated in order to separate the peak again for the subsequent signal processing.

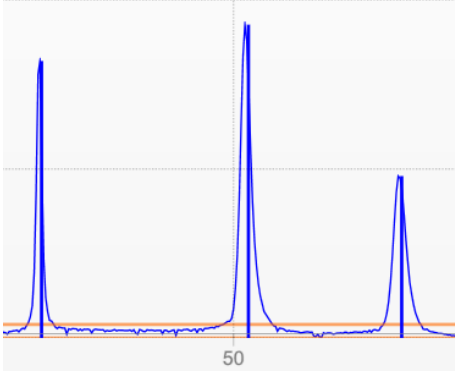

Fig. 46 Separated peaks: Measurement possible

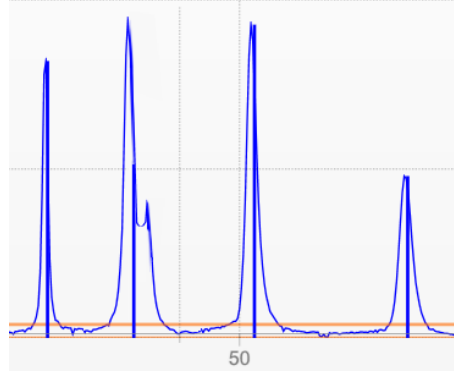

Fig. 47 Peaks interlocking: Measurement inaccuracy likely

The modulation is individually evaluated for each peak detected with the detection threshold.

Default value is 50 % as a compromise between the separability of the peaks and the measurement uncertainty due to mutual peak interference.

- Increase the value when the controller separates peaks which should be processed together.
- Decrease the value when the controller does not separate peaks which should be processed separately.

Example 1: With the default setting, no peak separation is carried out. The controller determines a distance from the center of gravity in the video signal.

Example 2: With a lower peak modulation value, the controller detects two separate peaks in the video signal and calculates the two distances.

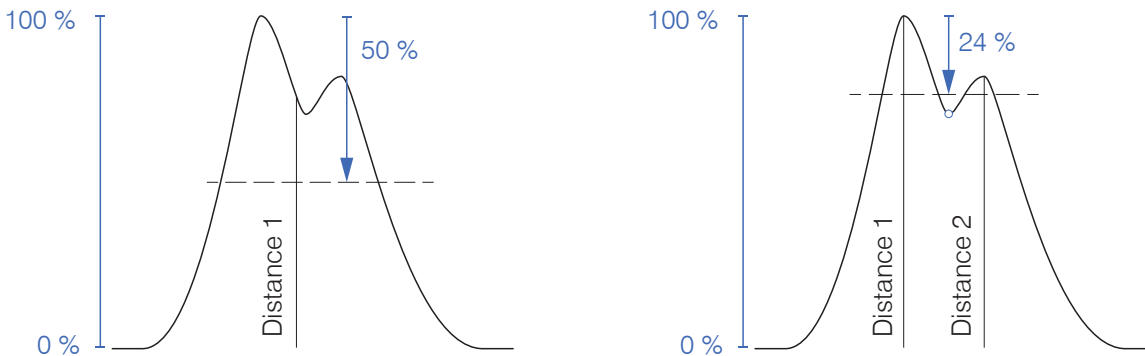

Fig. 48 Examples for peak modulation

Changing the peak modulation is only necessary in special cases. Use this function carefully.

6.2.6.2 Detection Threshold

The detection threshold (in % relative to the dark-corrected signal) defines the intensity as of which a peak in the video signal is included in the analysis. For that reason, it is essential to evaluate the video curve for this determination.

Minimum threshold	Value	Value in %, default 2 %
-------------------	-------	-------------------------

Defining the detection threshold.

- For very weak signals typical of extremely high measuring rates, choose a low detection threshold, as only signal parts above this threshold will be included in the calculation.
- In general, set the threshold high enough to prevent any interfering video signal peaks from being detected.

The detection threshold affects linearity, so it is recommended to adjust it as little as possible.

6.2.7 Number of Peaks, Peak Selection

The number of peaks is equivalent to the number of transitions between different materials of a target within the measuring range.

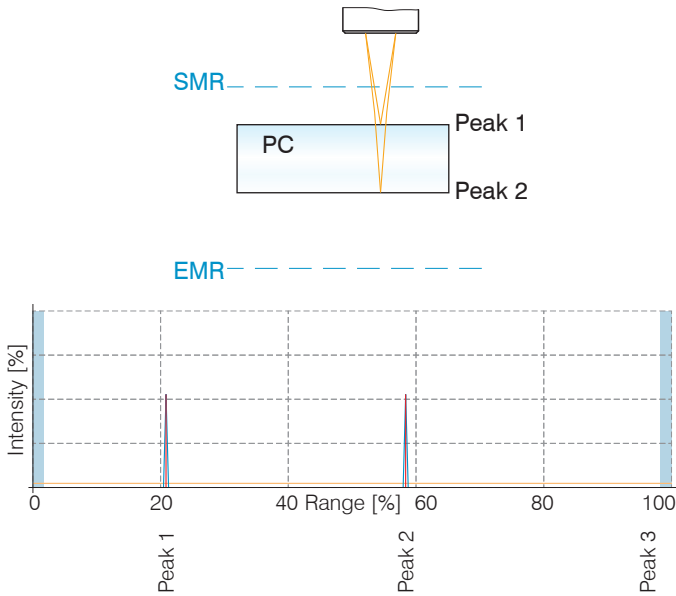

Fig. 49 Transparent target with one layer

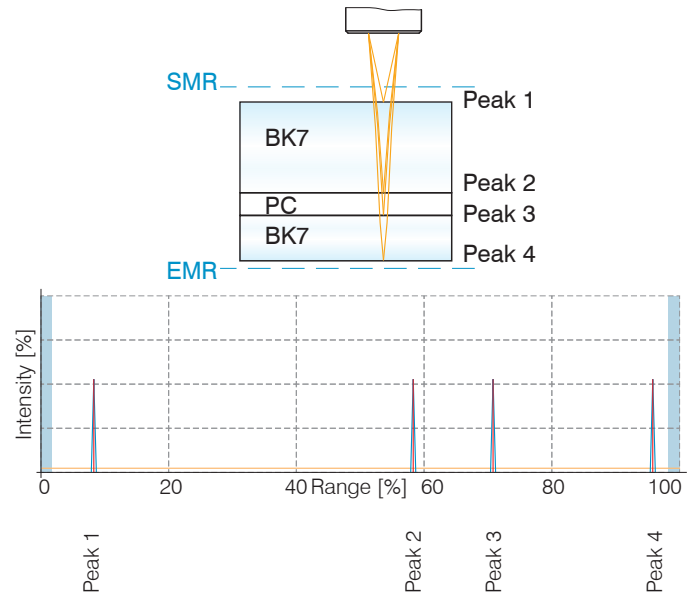

Fig. 50 Transparent target with three layers

This function is used if, before or between the useful peaks, a material has even smaller interfering peaks caused by thin layers on the target. This function should be used with caution and should only be used by product specialists.

The selection of peak/peaks dictates which regions in the signal are used for the distance or thickness measurement. In the case of a target consisting of several transparent layers, the material must be assigned to the individual layers, see Chap. 6.2.8.

The peaks are counted starting at the start of the measuring range toward the end of the measuring range.

Peak selection	<p><i>First peak / Highest peak / Last peak</i></p>	<p><i>Defines which signal in the array signal is used for the evaluation.</i></p> <p><i>First peak: Closest peak to the sensor.</i></p> <p><i>Highest peak: Standard, peak with the highest intensity.</i></p> <p><i>Last peak: Farthest peak from the sensor.</i></p>	
----------------	---	---	--

IFD2410/2411	IFD2415	Measured values	Peak selection
•	•	1 measured value	First peak / Highest peak / Last peak
	•	2 measured values	first and second peak / first and last peak / highest and second highest peak / second to last and last peak
	•	3 measured values	Individual
	•	4 measured values	Individual
	•	5 measured values	Individual
	•	6 measured values	Individual

Fig. 51 Options for peak selection

The determination of the peak heights is performed based on light corrected signal.

The refractivity correction is performed with the standard setting. However, if more than two peaks are within the measuring range, an exact refractivity correction is performed with the same amount of peaks only. If, for example, the first or last peak of 3 peaks sometimes leaves the measuring range, it is better to switch off the refractivity correction, because then the refractivity correction will be applied to a different layer, it will not be possible to clearly assign the material.

6.2.8 Material Selection

Before selecting a material, define the number of layers of the target or the number of peaks to be expected in the video signal, see Chap. 6.2.7. Otherwise, it will not be possible to assign the material.

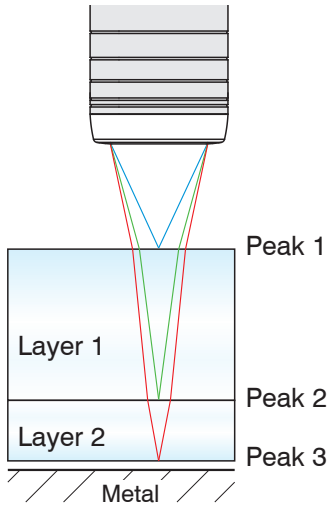

The refractive index needs to be corrected in the controller for an exact distance or thickness measurement.

- Switch to the menu Settings > Data recording > Material selection.
- Activate the refractivity correction. To do so, click the On button in the menu On/off refractivity correction.
- Assign the materials to the individual layers according to the target used.

Fig. 52 Layer structure of a target

The Link to material table button can be used to expand or reduce the material database in the controller. For a new material, a refractive index and the Abbe number v_D are required or three refractive index numbers are required if there are different wavelengths (also approximately the same).

Material selection

On/off refractive correction:

Layer 1:

Layer 2:

Link to material table

pos	material name	definition	nF at 486nm	nd at 587nm	nC at 656nm	VD - Abbe number	description
1	Vacuum	NX	1.000000	1.000000	1.000000		vacuum, air (approximately)
2	Water	NX	1.337121	1.333044	1.331152		a liquid
3	Ethanol	NX	1.361400	1.361400	1.361400		ethyl alcohol, pure alcohol (a liquid)
4	Acrylic	NX	1.497828	1.491668	1.488938		acrylic resin, adhesive, lacquer
5	PMMA	NX	1.497761	1.491756	1.489200		polymethyl methacrylate, acrylic glass (a plastic)

Fig. 53 Selection of material-specific refractivity indices

6.3 Signal Processing, Calculation

6.3.1 Data Source, Parameters, Calculation Programs

One calculation operation can be performed in each calculation block. The calculation program, the data sources and the parameters of the calculation program must be set for this.

Thickness	Calculating the difference	Two signals or results, Signal distance B < Signal distance A
Formula	Distance A - Distance B	
Calculation	Summation	Two signals or results
Formula	Factor 1 * Distance A + Factor 2 * Distance B + Offset	
Median	The measured values are sorted and the mean value is output as median	
Moving averaging	The arithmetic mean is formed	
Recursive averaging	Each new measured value is weighted and added to the sum of the previous mean values.	
Duplicate	Creates a copy of a signal	

Fig. 54 Available calculation programs

Sequence for creating a calculation block, see Fig. 55:

➤ Select a program ①, e.g. average.

➤ Define the parameters ②.

➤ Define the data source(s) ③.

➤ Enter a block name ④.

➤ Click on the Save calculation button.

Fig. 55 Sequence for the program selection

The programs calculation and thickness have two data sources. Averaging programs each have one data source.

Calculation parameters (calculation program)	Factor 1 / 2	Value	-32768.0 ... 32767.0
	Offset	Value	-2147.0 ... 2147.0
Calculation parameters (Averaging)	Averaging type	Recursive / Moving / Median	
	Number of values	Value	Recursive: 2 ... 32000
			Moving: 2 / 4 / 8 / 16 / 32 / 64 / 128 / 256 / 512 / 1024 / 2048 / 4096
Median: 3/5/7/9			

The number of values states over how many sequential measured values in the controller should be averaged before a new measured value is output.

6.3.2 Definitions

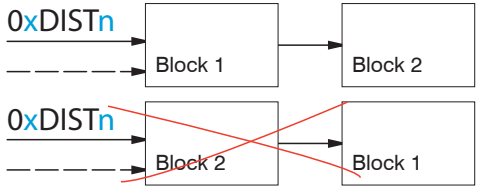
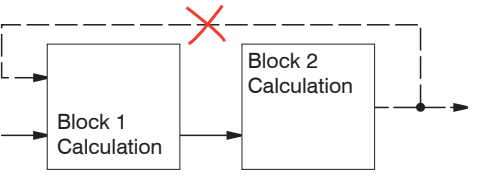
<p>Distance value(s)</p>	<p>01DIST1, 01DIST2, ... 01DIST6</p>
<p>Max. 10 calculation blocks per channel/sensor. The calculation blocks are processed sequentially.</p>	
<p>Feedback couplings (algebraic loops) over one or several blocks are not possible. Only the distance values or the calculated results from the previous calculation blocks can be used as data sources.</p>	
<p>Processing sequence:</p> <ol style="list-style-type: none"> 1. Unlinearized distances 2. Linearization of distances 3. Refractivity correction of distances 4. Error handling in the case of no valid measured value 5. Spike correction of distances 6. Calculation blocks 7. Statistics 	

6.3.3 Measurement Averaging

Measurement averaging is performed after measured values have been calculated, and before they are issued or processed through the relevant interfaces.

Measurement averaging

- improves the resolution,
- allows masking individual interference points, and
- “smoothes” the reading.

i Linearity is not affected by averaging. Averaging has no effect on measuring rate and output rate.

i The internal average value is re-calculated for each measuring cycle.

i The defined type of average value and the number of values must be saved in the controller to ensure they are maintained after it has been switched off.

The controller is delivered with “moving average, averaging value = 16” as factory settings, i.e. averaging is not enabled by default.

Moving Average

The definable number N for successive measurements (window width) is used to calculate the arithmetic average M_{mov} according to the following formula:

$$M_{mov} = \frac{\sum_{k=1}^N MV(k)}{N}$$

MV = measured value,
 N = averaging value,
 k = continuous index (in the window)
 M_{mov} = average value or output value

Each new measured value is added, and the first (oldest) value is removed from the averaging (from the window). This produces short settling times in case of measurement jumps.

Example: $N = 4$

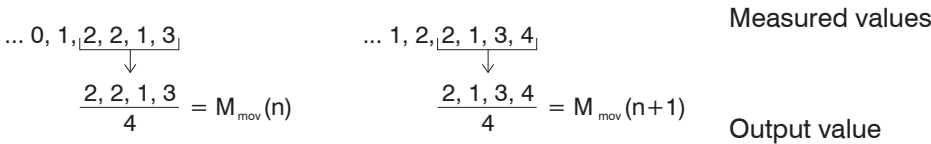

i Moving average in the controller allows only potentials of 2 for N. The highest averaging value is 1024.

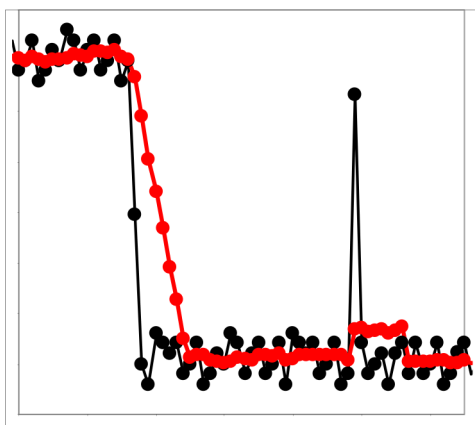

— Signal without averaging
 — Signal with averaging

Application tips

- Smoothing of measured values
- The effect can be finely controlled in comparison with the recursive averaging
- With uniform noise of the measured values without spikes
- In case of a slightly rough surface, in which the roughness should be eliminated
- Also suitable for measured value jumps with relatively short settling times

Fig. 56 Moving average, $N = 8$

Recursive average

Formula:

$$M_{rec}(n) = \frac{MV_{(n)} + (N-1) \times M_{rec(n-1)}}{N}$$

MV = measured value,

N = averaging value, $N = 1 \dots 32768$

n = Measured value index

M_{rec} = average or output value

The weighted value of each new measured value $MV(n)$ is added to the sum of the previous average values $M_{rec}(n-1)$.

Recursive averaging allows for very strong smoothing of the measurements, however it requires long response times for measurement jumps. The recursive average value shows low-pass behavior.

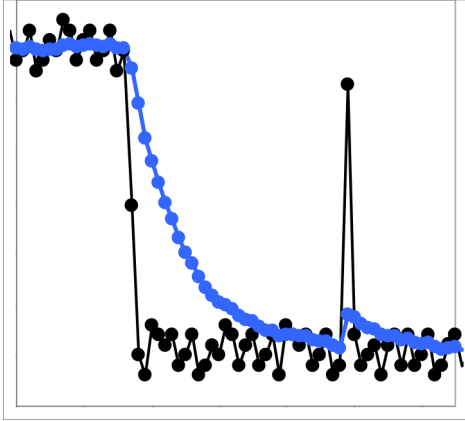

— Signal without averaging
 — Signal with averaging

Fig. 57 Recursive average, $N = 8$

Application tips

- Permits a high degree of smoothing of the measured values. Long transient recovery times in case of measured value jumps (low-pass behavior)
- High degree of smoothing for noise without strong spikes
- To especially smooth signal noise for static measurements
- To eliminate the roughness for dynamic measurements on rough surface, e.g. roughness of paper
- To eliminate structures, e.g., parts with uniform groove structures, knurled turned parts or coarsely milled parts
- Unsuitable for highly dynamic measurements

Median

A median value is formed from a preselected number of measured values.

When creating a median value for the controller, incoming measured values are sorted after each measurement. Then the average value is provided as the median value.

3, 5, 7 or 9 readings are taken into account. This means that individual interference pulses can be suppressed. However, smoothing of the measurement curves is not very strong.

Example: Median value from five readings

... 0 1 2 4 5 1 3 → Sorted measurement values: 1 2 **3** 4 5 Median_(n) = 3
 ... 1 2 4 5 1 3 5 → Sorted measurement values: 1 3 **4** 5 5 Median_(n+1) = 4

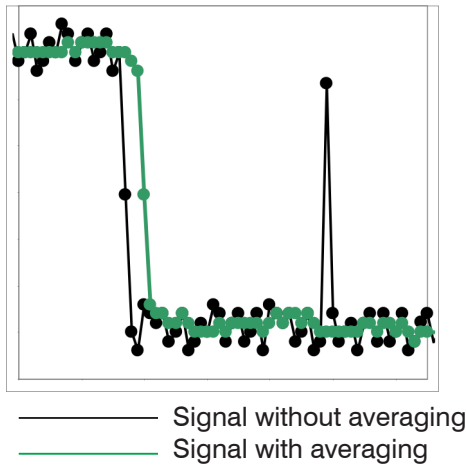

Application tips

- The measured value curve is not smoothed to a great extent; it primarily eliminates spikes
- Suppresses individual interference pulses
- In short, strong signal peaks (spikes)
- Also suitable for edge jumps (only minor influence)
- To eliminate dirt or roughness in a rough, dusty or dirty environment
- Further averaging can be used after the median filter

Fig. 58 Median, N = 7

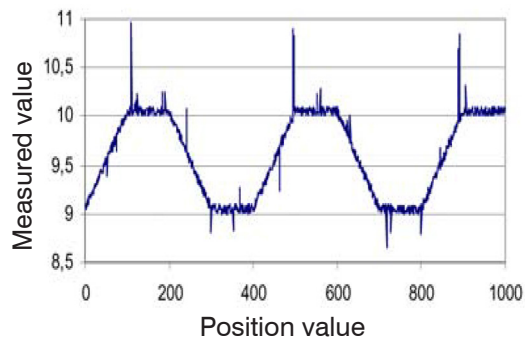

Fig. 59 Profile, original

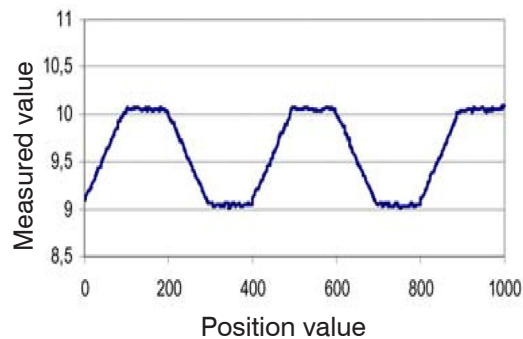

Fig. 60 Profile with median, N = 9

6.4 Post-Processing

6.4.1 Zeroing, Mastering

Use zeroing and mastering to define a nominal value within the measuring range. This shifts the output range. This feature can be useful, for example, when several sensors carry out measurements simultaneously in thickness and planarity measurements. When measuring the thickness of a transparent target, you need to specify the actual thickness of a master object as `Master value`.

Master value in mm	Value	Specify the thickness (or other parameter) of a master object. Value range: -2147.0 ... +2147.0 mm
-----------------------	-------	---

Mastering (setting masters) is used to compensate for mechanical tolerances in the sensor measurement setup or to correct chronological (thermal) changes to the measuring system. The master value, also called calibration value, is defined as the nominal value.

The `master value` is the reading that is issued as result of measuring a master object. Zeroing is a special feature of mastering, since the master value is “0” here.

The mastering/zeroing function is not channel-specific. The controller manages up to 10 master signals. These 10 signals can be applied to any internally determined value, including calculated values.

“Mastering” or “zeroing” requires a target object to be present in the measuring range. “Mastering” and “zeroing” affect both analog and digital outputs, as well as the web interface display.

Position	Signal	Value in mm
1	01DIST1	1.700

- 1 Trigger or undo mastering via multifunction inputs MFI 1/2 through an external source.
- 2 Selection of signals to be mastered via the multifunction inputs (1).
Overview of all existing signals for the function.
- 3 Selection of a signal to assign the master value with (4) and (5).
- 4 Enter master value.
- 5 Button for storing or deleting a signal from (3).
- 6 Apply selection of a specific signal or master to all defined signals (8).
- 7 Start or stop function for signal (6) via software.
- 8 Overview of all existing signals and their master value for the function.

Fig. 61 Mastering dialog, overview of individual master values

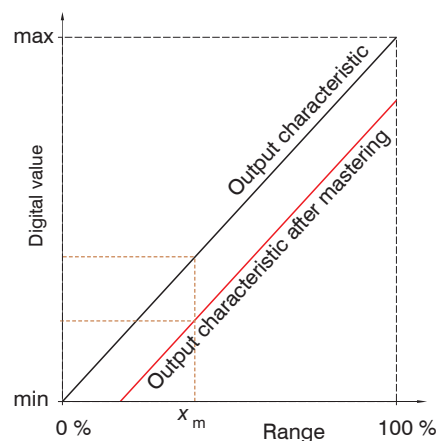

When setting a master, the output characteristic is moved in parallel. Moving the characteristic reduces the relevant measuring range of a sensor (the further master value and master position are located, the greater the reduction).

Mastering / Zeroing Sequence:

- ➡ Place target and sensor into their desired positions to one another.
- ➡ Define the `Master value` (web interface/ASCII).

After setting the master, the controller will issue new readings that relate to the master value. If you click the `Reset master value` button to undo the mastering process, the system reverts to the state that existed before the master was set.

Fig. 62 Moving the characteristic when mastering

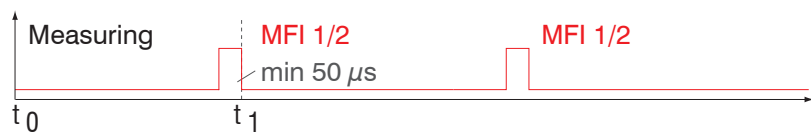

Fig. 63 Flowchart for zeroing, mastering (Multifunction key)

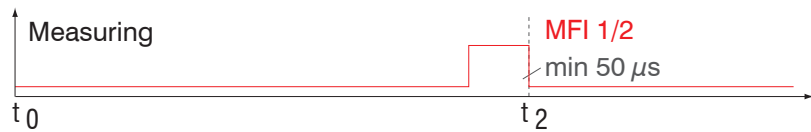

Fig. 64 Flowchart for undoing zeroing/mastering

The zeroing/mastering function can be applied several times in a row.

6.4.2 Statistics

The controller derives the following statistical values from the measurement result:

- Minimum,
- Maximum and
- Peak-to-Peak.

Statistical values are calculated from measured values within the evaluation range. The evaluation range is updated with every new measurement value. Statistical values are displayed in the web interface, the `measurement chart` or are output via the interfaces.

Position	Signal	Statistic value
1	01DIST1	2048
2	01DIST3	2048
3	R1	4096

The statistical values are not channel-specific. The controller manages up to 10 statistical values. These 10 signals can be applied to any internally determined value. This also applies for calculated values.

Fig. 65 Statistics dialog, overview of individual statistic values

- 1 Use the `Reset statistic value` button to reset a certain signal or all statistic signals in order to start a new evaluation cycle (storage period). When a new cycle starts, previous statistical values are deleted.
- 2 Deletes a signal.
- 3 Number of measurement values based on which minimum, maximum and peak-to-peak are determined for a signal. The range of values used for calculation can be between 2 and 16384 (in powers of 2) or include all measured values.
- 4 Selects a signal for the function.
- 5 Overview of all existing signals for the function.

Sequence for creating a statistical evaluation:

- ▶ Change to the tab `Settings > Postprocessing > Statistics`.
- ▶ Choose a signal (4) for which the statistical values should be calculated.
- ▶ Define the evaluation range via the `statistic value`.

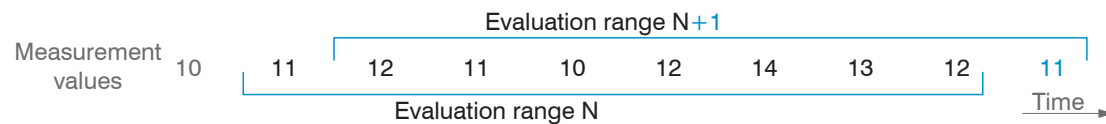

Fig. 66 Dynamic update of evaluation range via measurement values, `statistic value = 8`

6.4.3 Data Reduction, Output Data Rate

Data reduction	Value	<i>Instructs the controller which data are excluded from the output, thus reducing the volume of data transmitted.</i>
Reduction applies to	RS422 / Analog	<i>The interfaces which are provided for the sub-sampling are to be selected with the checkbox.</i>

You can reduce the measurement output in the sensor if you set the output of every nth measured value in the web interface or by command. Data reductions causes only every nth measured value to be output. The other measured values are rejected. The reduction value n can range from 1 (each measured value) to 3,000,000. This allows you to adjust slower processes, such as a PLC, to the fast sensor without having to reduce the measuring rate.

6.4.4 Error Handling (Hold Last Value)

If no valid measured value can be determined, an error is output. Alternatively, if this interferes with further processing, the last valid value can be held, i.e. output repeatedly, for a certain amount of time.

Error handling	Error output, no measured value	<i>Interfaces output an error instead of a value.</i>	
	Hold last value infinitely	<i>Interfaces output the last valid value until a new, valid measured value is available.</i>	
	Hold last value	Value	<i>Possible number of values to be maintained between 1 and 1024. When number = 0, the last value is maintained until a new, valid value is displayed.</i>

6.5 Outputs

6.5.1 Interface RS422

The RS422 interface has a maximum baud rate of 4000 kBaud. The baud rate is set to 115.2 kBaud when the interface is delivered. Use ASCII commands or the web interface to configure.

Transfer settings for controller and PC must match.

Data format: Binary.. Interface parameters: 8 data bits, no parity, one stop bit (8N1). Selectable baud rate.

The RS422 interface transmits 18 bits per output value.

The maximum number of measured values that can be transmitted for a measuring point depends on the measuring rate of the controller and the transmission rate set for the RS422 interface. Use the maximum available transmission rate (baud rate) where possible.

Parallel output of measuring data is not possible via RS422 and EtherCAT.

6.5.2 Ethernet Setup Mode

When using a static IP address it is necessary to enter the values for the IP address, Gateway and Subnet mask; this is not required when DHCP is used.

The controller is set at the factory to the static IP address 169.254.168.150.

In Ethernet setup mode

- EtherCAT communication is not possible,
- RS422-communication and data transmission are possible.

Ethernet setup mode is used to configure the IFD241x via web interface.

6.5.3 RS422

The selection of output data from all internally determined values and from the calculated values from the computing modules is done separately for both interfaces. These data are output in a rigidly defined order.

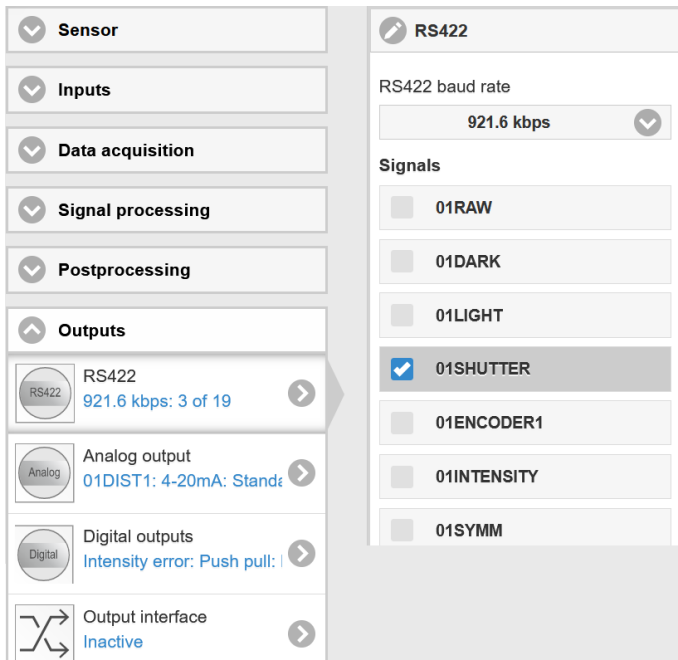

Fig. 67 Selecting the output data

6.5.4 Analog Output

Only one measured value can be transmitted. The resolution of the analog output is 16 bit.

Output signal	01DIST1 / ... 01DIST6 / ...	The data selection depends on the current setting and includes the results from the calculation modules as well as the distance values.	
Output range	4 ... 20 mA / 0 ... 5 V / 0 ... 10 V	Either the voltage or the current output can be used on the IFD241x.	
Scaling	Standard scaling	Scaling to 0 ... Measuring range	
	Two-point scaling	Start of range corresponds to (in mm):	Value
		End of range corresponds to (in mm):	Value

The first value corresponds to the start of the measuring range and the second value to the end of the measuring range. If the analog range needs to be moved, we recommend using the zeroing or mastering function.

Two-point scaling enables the user to specify separate start and end values (in mm) for the sensor’s measuring range. The available output range of the analog output is then spread between the minimum and maximum measured values. This allows for decreasing analog characteristics, see Fig. 68.

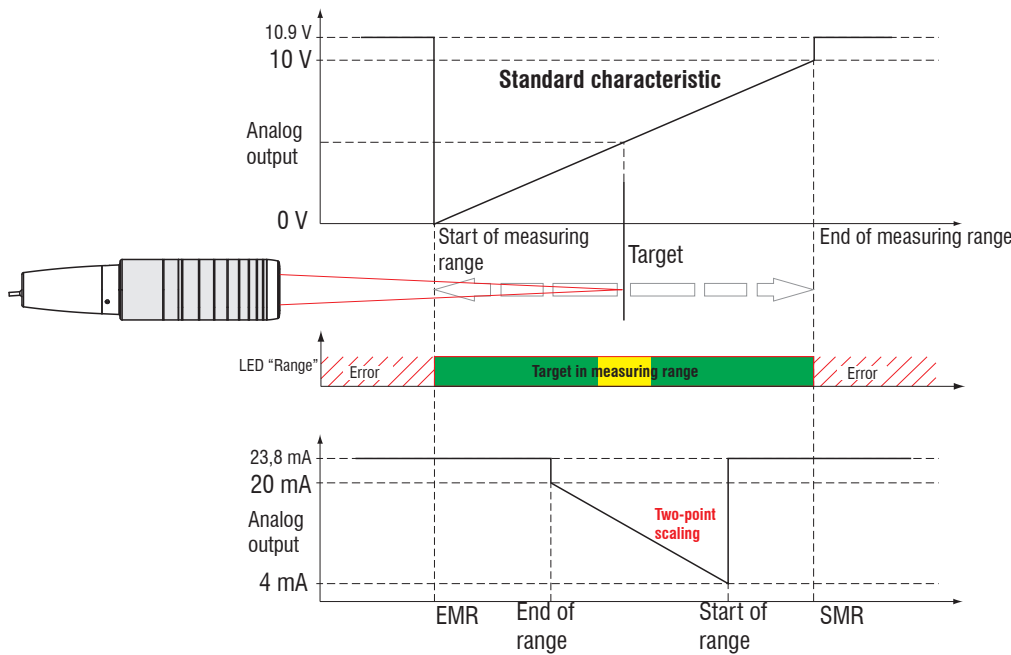

Fig. 68 Scaling the analog signal

6.5.4.1 Calculating Measured Value from Current Output

Current output (without mastering, without two-point scaling)

Variables	Value range	Formula
I_{OUT} = Current [mA]	[3.8; <4] SMR reserve [4; 20] measuring range [>20; 20.2] EMR reserve	$d = \frac{(I_{OUT} - 4)}{16} * MR$
MR = measuring range [mm]	{/1/2/3/6/10}	
d = Distance [mm]	[-0.01MB; 1.01MB]	

Current output (with two-point scaling)

Variables	Value range	Formula
I_{OUT} = Current [mA]	[3.8; <4] SMR reserve [4; 20] measuring range [>20; 20.2] EMR reserve	$d = \frac{(I_{OUT} - 4)}{16} * n - m $
MR = measuring range [mm]	{/1/2/3/6/10}	
m, n = Teach range [mm]	[0; MR]	
d = Distance [mm]	[m; n]	

6.5.4.2 Calculation measured value from Voltage Output

Voltage output (without mastering, without two-point scaling)

Variables	Value range	Formula
U_{OUT} = voltage [V]	[-0.05; <0] SMR reserve [0; 5] measuring range [>5; 5.05] EMR reserve	$d = \frac{V_{OUT}}{5} * MR$
	[-0.1; <0] SMR reserve [0; 10] measuring range [>10; 10.1] EMR reserve	$d = \frac{V_{OUT}}{10} * MR$
MR = measuring range [mm]	{/1/2/3/6/10}	
d = Distance [mm]	[-0.01MB; 1.01MB]	

Current output (with two-point scaling)

Variables	Value range	Formula
U_{OUT} = voltage [V]	[-0.05; <0] SMR reserve [0; 5] measuring range [>5; 5.05] EMR reserve	$d = \frac{V_{OUT}}{5} * n - m $
	[-0.1; <0] SMR reserve [0; 10] measuring range [>10; 10.1] EMR reserve	$d = \frac{V_{OUT}}{10} * n - m $
MR = measuring range [mm]	{/1/2/3/6/10}	
m, n = Teach range [mm]	[0; MR]	
d = Distance [mm]	[m; n]	

6.5.5 Data Output

Output interfaces	RS422 / analog output / switching output	Decides on the interface used for outputting the measured value. The measured values are output in parallel via the interfaces selected.
-------------------	--	--

6.6 System Settings

6.6.1 Web Interface Unit

The web interface supports units in millimeters (mm) and inches in the display of the measurement results. The language in the web interface can be set to German or English. Switch the language in the menu bar.

6.6.2 Key Lock

The key lock prevents unauthorized or unintentional execution of the key functions. A key lock can be set individually for the Multifunction and/or Correct key.

Key Lock	Automatic	Value (1 ... 60 min)	<i>The button function will be blocked after a defined period of time has elapsed.</i>
	Active		<i>The key function is blocked immediately</i>
	Inactive		<i>No key lock</i>

The key lock can only be deactivated with Professional access authorization.

6.6.3 Loading and Saving

This chapter describes how to save a setup with either measurement settings or with device settings. You will also find the functions for importing and exporting the setups here, see Chap. 5.9.

6.6.4 Access Authorization

Assigning passwords prevents unauthorized changes to settings in the system. Password protection is not activated in the delivery state. The controller works on user level Professional. Once the controller has been configured, the password protection should be activated. The standard password for the Professional level is "000".

I A software update will not change the standard password or a user-defined password. The Professional password is independent of the setup and is therefore not loaded or saved together with the setup.

Users have the following functions available:

	User	Professional
Password required	no	yes
View settings	yes	yes
Change settings, change passwords	no	yes
View measured values, video signals	yes	yes
Scale graphs	yes	yes
Restore factory settings	no	yes

Fig. 69 Rights in the user hierarchy

Type the standard password "000" or a user-defined password in the Password field and confirm the entry with Login.

Fig. 70 Switch to user level Professional

The user management enables the assignment of a user-defined password in operating mode Professional.

Password	<i>Value</i>	<i>All passwords are case-sensitive; numbers are allowed. Special characters are not permitted.</i>
User level when restarting	<i>User / Professional</i>	<i>Defines the user level which the system starts in after it has been switched on again. MICRO-EPSILON recommends the selection Professional here.</i>

6.6.5 Reset System

You can reset individual settings to the factory setting in this menu area.

Device settings	<i>The settings for the following commands are reset to the factory settings: ANALOG RANGE, BAUD RATE, ECHO, KEYLOCK, LED.</i>
Measurement settings	<i>Resets the preset to Standard matt and all parameters, except for interface settings, to the factory setting.</i>
Reset material database	<i>All settings for the material table are set to factory setting.</i>
Reset all	<i>Resets the device and measurement settings to factory settings.</i>
Restart sensor	<i>Starts the system with the last settings saved</i>

6.6.6 Light Source

You can switch the light source for the system on or off. This can be done via software or with the multifunctional inputs MF1/2.

6.6.7 Boot Mode

This setting determines the connection protocol when the system is started. EtherCAT is standard. To parameterize the measuring system via web interface, the IFD241x can optionally be operated in Ethernet setup mode. Save the current settings before switching to EtherCAT. The switch only becomes active after the system has been restarted.

Switching between Ethernet setup mode and EtherCAT can also be done using an ASCII command, see [Chap. A 5.3.16.2](#). The selected operating mode is loaded, then the IFD241x is automatically restarted. The measuring system must not be disconnected from the power supply during this time. If the selected boot mode is already active, no action will be executed.

The RS422 interface for sending an ASCII command can be accessed both in Ethernet setup mode and in EtherCAT mode.

7. Thickness Measurement, One-Sided, Transparent Target

7.1 Requirement

For a one-sided thickness measurement of a transparent target, the controller evaluates two signals reflected at the surfaces. Based on these two signals, the controller calculates the distances from the surfaces and, from this, derives the thickness.

➤ Align the sensor perpendicularly to the object to be measured. Make sure that the target is approximately in the mid of the measuring range (SMR + 0.5 x MR).

i The light beam must strike the surface of the object at a perpendicular angle. Otherwise, measurements might be inaccurate.

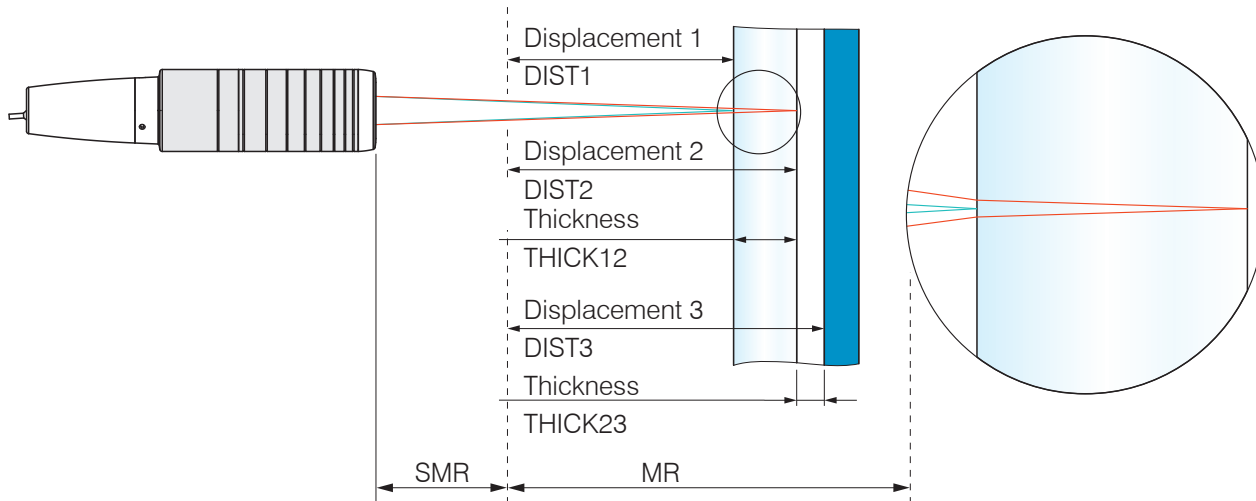

Fig. 71 One-sided thickness measurement on a transparent target

SMR Start of measuring range
 MR Measuring range
 Minimum target thickness See Technical Data
 Maximum target thickness See Technical Data

7.2 Preset

confocalDT IFD2410/2415	confocalDT IFD2411
➤ Switch to the Home menu.	
➤ Select Multilayer airgap in the configuration selection.	➤ Select One-sided thickness measurement in the configuration selection.

This presetting prompts the controller to use the first and second peak in the video signal for the thickness calculation.

Calculation 1 in controller: Thickness difference from DIST2 and DIST1	Calculation 1 in controller: Thickness difference from DIST2 and DIST1
Calculation 2 in controller: Thickness difference from DIST3 and DIST2	---

7.3 Material Selection

Specifying the material is essential for calculating a correct thickness value. To compensate for the spectral change of the index of refraction, at least three refractive indices at different wavelengths or a refractive index and the Abbe number must be known.

➤ Switch to the Settings > Data recording > Material selection menu.

➤ Select the material of the target for Layer 1 and Layer 2 (if applicable).

7.4 Video Signal

If a surface of the target lies outside the measuring range, the controller will send only one signal for the distance, intensity and center of gravity. This may also occur if a signal is below the detection threshold.

Two boundary surfaces are active when the thickness of a transparent material is measured. As a result, two peaks are visible in the video signal, see Fig. 72.

Even if the detection threshold is just below the saddle between the two peaks, the controller can determine both distances and calculate the thickness from them.

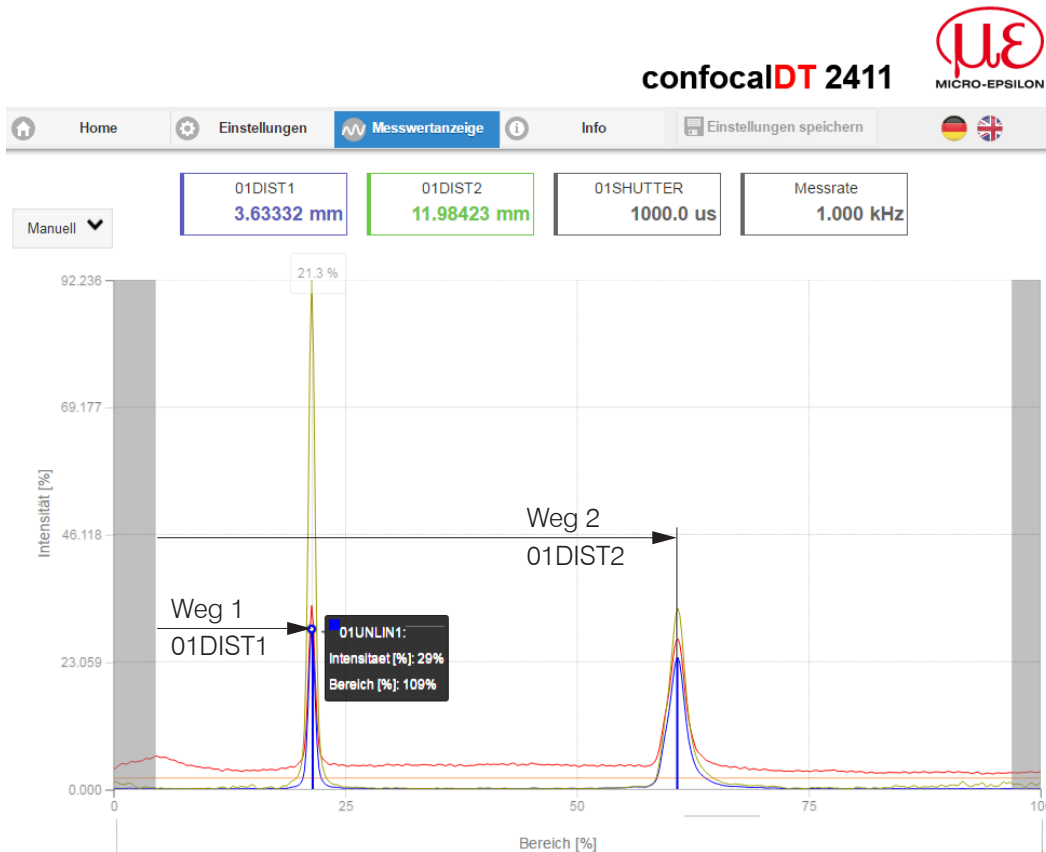

Fig. 72 Video signal web page, One-sided thickness measurement

7.5 Signal Processing

The configuration selection One-sided thickness measurement also contains the presets for thickness calculation from the two distance signals Displacement1 and Displacement2, see Fig. 72.

In the downstream second calculation block Calculation 2, the thickness values undergo a moving averaging with an averaging depth of 16 values.

➡ Adapt the signal processing to your measuring task.

<ul style="list-style-type: none"> ▼ Sensor ▼ Inputs ▼ Data acquisition ▲ Signal processing $\tau = \frac{n-1}{2}$ Calculation 1 Thickness: 01DIST2: 01DI $\tau = \frac{n-1}{2}$ Calculation 2 Moving averaging: Ch01T + Add calc module 	<ul style="list-style-type: none"> ⚙ Calculation 1 Calculation function: Thickness Distance A: 01DIST2 Distance B: 01DIST1 Name: Ch01Thick12 Apply calculation
---	--

7.6 Measurement Chart

➡ Switch to the Measurement chart tab and select Meas as the chart type.

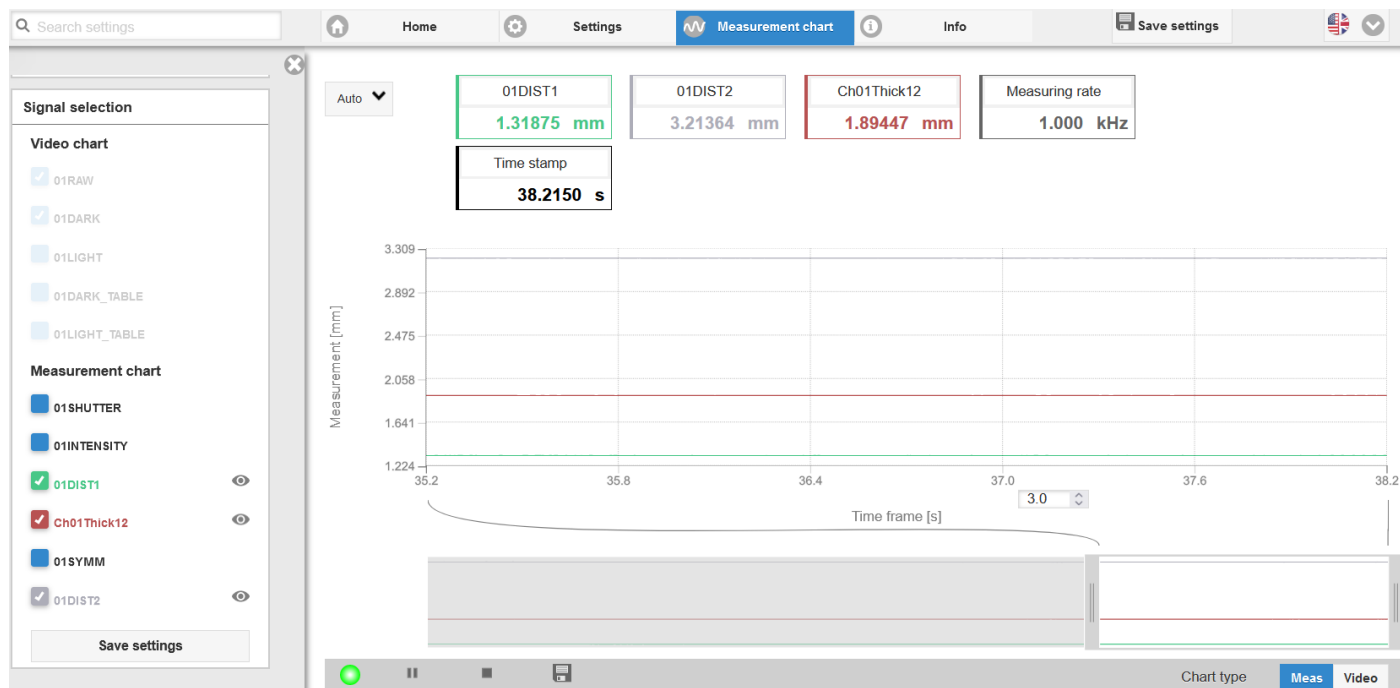

Fig. 73 Measured thickness results based on a one-sided thickness measurement with one sensor

The web page shows the two distances and the thickness (difference between 01DIST2 and 01DIST1) graphically and numerically. Optionally, the intensities of both peaks (Peak 1 = near, Peak 2 = far) can also be displayed.

8. EtherCAT Documentation

8.1 General

From an Ethernet point of view, EtherCAT® is an individual large Ethernet device that sends and receives Ethernet telegrams. An EtherCAT system like this consists of an EtherCAT master and up to 65535 EtherCAT slaves.

Master and slaves communicate via standard Ethernet cabling. On-the-fly processing hardware is used in each slave. The incoming Ethernet frames are processed by the hardware directly. The relevant data is extracted from the frame or inserted. The frame is then sent on to the next EtherCAT® slave device. The fully processed frame is returned from the last slave device. Various protocols can be used at the application level. CANopen over EtherCAT technology (CoE) is supported here. An object dictionary structure with service data objects (SDO) and process data objects (PDO) is used to manage the data in the CANopen protocol. You can get further information from the ® Technology Group (www.ethercat.org) or Beckhoff GmbH, (www.beckhoff.com).

8.2 Introduction

8.2.1 Structure of EtherCAT® Frames

The data in Ethernet frames is transmitted with a special Ether type (0x88A4). An EtherCAT® frame like this consists of one or more EtherCAT® telegrams, each of which is addressed to individual slaves / storage areas. The telegrams are transmitted either directly in the data area of the Ethernet frame or in the data area of the UDP datagram. An EtherCAT® telegram consists of an EtherCAT® header, the data area and the work counter (WC). The work counter is incremented by each addressed EtherCAT® slave that has exchanged the associated data.

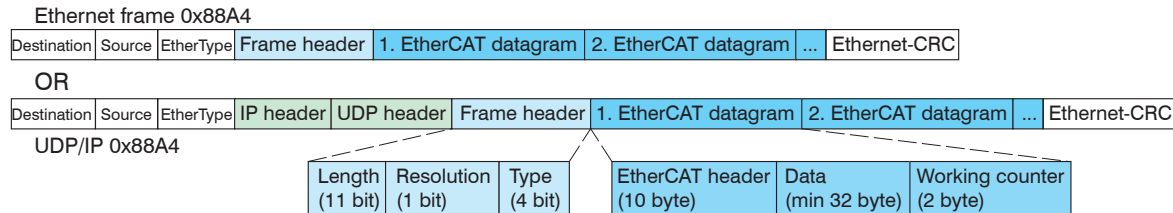

Fig. 74 Structure of EtherCAT® frames

8.2.2 EtherCAT® Services

In EtherCAT®, services are specified for reading and writing data in the physical memory within the slave hardware. The following EtherCAT® services are supported by the slave hardware:

- APRD (Autoincrement physical read, reading of a physical area with auto-increment addressing)
- APWR (Autoincrement physical write, writing of a physical area with auto-increment addressing)
- APRW (Autoincrement physical read write, reading and writing of a physical area with auto-increment addressing)
- FPRD (Configured address read, reading of a physical area with fixed addressing)
- FPWR (Configured address write, writing of a physical area with fixed addressing)
- FPRW (Configured address read write, reading and writing of a physical area with fixed addressing)
- BRD (Broadcast Read, broadcast reading of a physical area for all slaves)
- BWR (Broadcast Write, broadcast writing of a physical area for all slaves)
- LRD (Logical read, reading of a logical storage area)
- LWR (Logical write, writing of a logical storage area)
- LRW (Logical read write, reading and writing of a logical storage area)
- ARMW (Auto increment physical read multiple write, reading of a physical area with auto-increment addressing, multiple writing)
- FRMW (Configured address read multiple write, reading of a physical area with fixed addressing, multiple writing)

8.2.3 Addressing and FMMUs

In order to address a slave in the EtherCAT® system, various methods from the master can be used. The confocalDT IFD241x supports as full slave:

- Position addressing
The slave device is addressed via its physical position in the EtherCAT® segment.
The services used for this are APRD, APWR, APRW.
- Node addressing
The slave device is addressed via a configured node address, which was assigned by the master during the commissioning phase. The services used for this are FPRD, FPWR and FPRW.
- Logical addressing
The slaves are not addressed individually; instead, a segment of the segment-wide logical 4-GB address is addressed. This segment can be used by a number of slaves.
The services used for this are LRD, LWR and LRW.

The local assignment of physical slave memory addresses and logical segment-wide addresses is implemented via the Field Bus Memory Management Units (FMMUs). The configuration of the slave FMMUs is implemented by the master. The FMMU configuration contains a start address of the physical memory in the slave, a logical start address in the global address space, length and type of the data, as well as the direction (input or output) of the process data.

8.2.4 Sync Manager

Sync Managers serve the data consistency during the data exchange between Ether-CAT® master and slaves. Each Sync Manager channel defines an area of the application memory. The confocalDT IFD241x has four channels:

- Sync-Manager-Channel 0: Sync Manager 0 is used for mailbox write transfers (mailbox from master to slave).
- Sync-Manager-Channel 1: Sync Manager 1 is used for mailbox read transfers (mailbox from slave to master).
- Sync-Manager-Channel 2: Sync Manager 2 is usually used for process output data. Not used in IFD241x.
- Sync-Manager-Channel 3: Sync Manager 3 is usually used for process input data. It contains the Tx PDOs that are specified by the PDO assignment object 0x1C13 (hex.).

8.2.5 EtherCAT State Machine

The EtherCAT® state machine is implemented in each EtherCAT®. Directly after switching on the confocalDT IFD241x, the state machine is in the “Initialization” state. In this state, the master has access to the DLL information register of the slave hardware. The mailbox is not yet initialized, i.e. communication with the application (controller software) is not yet possible. During the transition to the pre-operational state, the Sync Manager channels are configured for the mailbox communication. In the “Pre-Operational” state, communication via the mailbox is possible, and it can access the object directory and its objects. In this state, no process data communication occurs. During the transition to the “Safe-Operational” state, the process-data mapping, the Sync Manager channel of the process inputs and the corresponding FMMU are configured by the master. Mailbox communication continues to be possible in the “Safe-Operational” state. The process data communication runs for the inputs. The outputs are in the “safe” state. In the “Operational” state, process data communication runs for the inputs as well as the outputs.

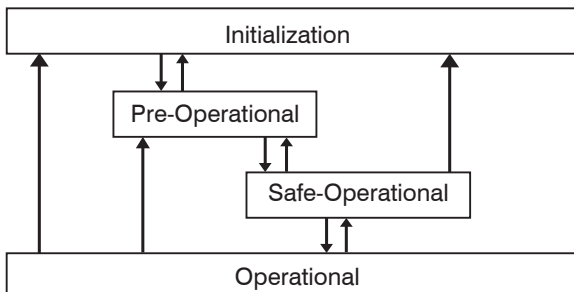

Fig. 75 EtherCAT State Machine

8.2.6 CANopen over EtherCAT

The application level communication protocol in EtherCAT is based on the communication profile CANopen DS 301 and is designated either as “CANopen over EtherCAT” or CoE. The protocol specifies the object directory in the IFD241x, as well as the communication objects for the exchange of process data and acyclic messages. The IFD241x uses the following message types:

- Process Data Object (PDO). The PDO is used for the cyclic I/O communication, therefore for process data.
- Service Data Object (SDO). The SDO is used for acyclic data transmission.

The object directory is described in the chapter CoE Object Directory.

8.2.7 Process Data PDO Mapping

Process Data Objects (PDOs) are used for the exchange of time-critical process data between master and slaves. Tx PDOs are used for the transmission of data from the slaves to the master (inputs). Rx PDOs are used to transmit data from the master to the slaves (outputs); not used in the confocalDT IFD241x. The PDO mapping defines which application objects (measurement data) are transmitted into a PDO.

With the confocalDT IFD2410/2411, a selection can be made from a series of Tx PDO map objects, see [Chap. 8.3.1.7](#).

With the confocalDT IFD2415, a selection can be made from a series of Tx PDO map objects, see [Chap. 8.3.1.8](#).

In EtherCAT, the PDOs are transported in objects of the Sync Manager channel. The IFD241x uses the Sync Manager channel SM3 for input data (Tx data). The PDO assignments of the Sync Manager can only be changed in the “Pre-Operational” state.

Note: Sub-index 0h of the object 0x1A00 contains the number of valid entries within the mapping report. This number also represents the number of application variables (parameters) that should be transmitted/received with the corresponding PDO. The subindices from 1h up to the number of objects contain information about the depicted application variables. The mapping values in the CANopen objects are coded in hexadecimal form.

The following table contains an example of the entry structure of the PDO mapping:

MSB			LSB		
31	16	15	8	7	0
Index e.g. 0x6000 (16 Bit)		Subindex e.g. 0x01		Object length in bits, e.g. 20h = 32 bits	

Fig. 76 Entry structure of the PDO mapping, example

8.2.8 Service Data SDO Service

Service Data Objects (SDOs) are primarily used for the transmission of data that is not time critical, e.g. parameter values.

EtherCAT specifies

- SDO services: these make possible the read/write access to entries in the CoE object directory of the device.
- SDO information services make it possible to read the object directory itself and to access the properties of the objects.

All parameters of the measuring device can be read or changed in this way, or measurements can be transmitted. A desired parameter is addressed via index and subindex within the object directory.

8.3 CoE – Object Directory

The CoE object directory (CANopen over EtherCAT) contains all the configuration data of the IFD241x. The objects in CoE object directory can be accessed using the SDO services. Each object is addressed using a 16-bit index.

8.3.1 Communication Specific Standard Objects

8.3.1.1 Overview

Index (h)	Name	Description
1000	Device type	Device type
1008	Device name	Manufacturer device name
1009	Hardware version	Hardware version
100 A	Software version	Software version
1018	Identity	Device identification
10F8	Timestamp	EtherCAT stack predefined object, not to be confused with the timestamp of the process data
1A00 ... 1B5B		TxPDO mapping, see Chap. 8.3.1.7 . Multiple process data (mappable objects - process data) are combined in the PDO mapping objects in some cases.
1C00	Sync. manager type	Synchronous manager type
1C12	RxPDO assign	Not used with the IFD241x
1C13	TxPDO assign	TxPDO assign
1C32	Sync manager output parameter	Synchronous mode parameter (DC)
1C33	Sync manager input parameter	

Fig. 77 Overview of standard objects

8.3.1.2 Object 1001h: Device Type

1000	VAR	Device type	0x00000000	Unsigned32	ro
------	-----	-------------	------------	------------	----

Provides information about the device profile and the device type used.

8.3.1.3 Object 1008h: Manufacturer Device Name

1008	VAR	Device name	IFC24xx	Visible String	ro
------	-----	-------------	---------	----------------	----

8.3.1.4 Object 1009h: Hardware Version

1009	VAR	Hardware version	xx	Visible String	ro
------	-----	------------------	----	----------------	----

8.3.1.5 Object 100Ah: Software Version

100 A	VAR	Software version	xxx.xxx	Visible String	ro
-------	-----	------------------	---------	----------------	----

8.3.1.6 Object 1018h: Device Identification

1018	RECORD	Identity			
------	--------	----------	--	--	--

Subindices

0	VAR	Number of entries	4	Unsigned8	ro
1	VAR	Vendor ID	0x00000607	Unsigned32	ro
2	VAR	Product code	0x0024E555	Unsigned32	ro
3	VAR	Revision	0x00010000	Unsigned32	ro
4	VAR	Serial number	0x009A4435	Unsigned32	ro

The product code identifies an EtherCAT device in the network. This identification is made up of vendor ID, product code and revision. Serial number contains the serial number of the IFD241x.

8.3.1.7 TxPDO Mapping IFD2410, 2411

0x1A00	Ch01Dist1 TxPDOMap OV1			
	:001 0x6000:001 Ch01Dist1_OV00			
0x1A01	Ch01Dist1 TxPDOMap OV2			
	:001 0x6000:001Ch01Dist1_OV00	:002 0x6000:002 Ch01Dist1_OV01		
0x1A02	Ch01Dist1 TxPDOMap OV4			
	:001 0x6000:001 Ch01Dist1_OV00	:002 0x6000:002 Ch01Dist1_OV01	:003 0x6000:003 Ch01Dist1_OV02	:004 0x6000:004 Ch01Dist1_OV03
0x1A03	Ch01Dist1 TxPDOMap OV8			
	:001 0x6000:001 Ch01Dist1_OV00	:002 0x6000:002 Ch01Dist1_OV01	:003 0x6000:003 Ch01Dist1_OV02	:004 0x6000:004 Ch01Dist1_OV03
	:005 0x6000:005 Ch01Dist1_OV04	:006 0x6000:006 Ch01Dist1_OV05	:007 0x6000:007 Ch01Dist1_OV06	:008 0x6000:008 Ch01Dist1_OV07

Fig. 78 Mapping for distance value DIST1

0x1A10	Ch01Dist2 TxPDOMap OV1			
	:001 0x6001:001 Ch01Dist2_OV00			
0x1A11	Ch01Dist2 TxPDOMap OV2			
	:001 0x6001:001 Ch01Dist2_OV00	:002 0x6001:002 Ch01Dist2_OV01		
0x1A12	Ch01Dist2 TxPDOMap OV4			
	:001 0x6001:001 Ch01Dist2_OV00	:002 0x6001:002 Ch01Dist2_OV01	:003 0x6001:003 Ch01Dist2_OV02	:004 0x6001:004 Ch01Dist2_OV03
0x1A13	Ch01Dist2 TxPDOMap OV8			
	:001 0x6001:001 Ch01Dist2_OV00	:002 0x6001:002 Ch01Dist2_OV01	:003 0x6001:003 Ch01Dist2_OV02	:004 0x6001:004 Ch01Dist2_OV03
	:005 0x6001:005 Ch01Dist2_OV04	:006 0x6001:006 Ch01Dist2_OV05	:007 0x6001:007 Ch01Dist2_OV06	:008 0x6001:008 Ch01Dist2_OV07

Fig. 79 Mapping for distance value DIST2

0x1A30	Ch01Intensity1 TxPDOMap OV1			
	:001 0x6010:001 Ch01Intensity1_OV00			
0x1A31	Ch01Intensity1 TxPDOMap OV2			
	:001 0x6010:001 Ch01Intensity1_OV00	:002 0x6010:002 Ch01Intensity1_OV01		
0x1A32	Ch01Intensity1 TxPDOMap OV4			
	:001 0x6010:001 Ch01Intensity1_OV00	:002 0x6010:002 Ch01Intensity1_OV01	:003 0x6010:003 Ch01Intensity1_OV02	:004 0x6010:004 Ch01Intensity1_OV03
0x1A33	Ch01Intensity1 TxPDOMap OV8			
	:001 0x6010:001 Ch01Intensity1_OV00	:002 0x6010:002 Ch01Intensity1_OV01	:003 0x6010:003 Ch01Intensity1_OV02	:004 0x6010:004 Ch01Intensity1_OV03
	:005 0x6010:005 Ch01Intensity1_OV04	:006 0x6010:006 Ch01Intensity1_OV05	:007 0x6010:007 Ch01Intensity1_OV06	:008 0x6010:008 Ch01Intensity1_OV07

Fig. 80 Mapping for intensity 1 of DIST1

0x1A40	Ch01Intensity2 TxPDOMap OV1			
	:001 0x6011:001 Ch01Intensity2_OV00			
0x1A41	Ch01Intensity2 TxPDOMap OV2			
	:001 0x6011:001 Ch01Intensity2_OV00	:002 0x6011:002 Ch01Intensity2_OV01		
0x1A42	Ch01Intensity2 TxPDOMap OV4			
	:001 0x6011:001 Ch01Intensity2_OV00	:002 0x6011:002 Ch01Intensity2_OV01	:003 0x6011:003 Ch01Intensity2_OV02	:004 0x6011:004 Ch01Intensity2_OV03
0x1A43	Ch01Intensity2 TxPDOMap OV8			
	:001 0x6011:001 Ch01Intensity2_OV00	:002 0x6011:002 Ch01Intensity2_OV01	:003 0x6011:003 Ch01Intensity2_OV02	:004 0x6011:004 Ch01Intensity2_OV03
	:005 0x6011:005 Ch01Intensity2_OV04	:006 0x6011:006 Ch01Intensity2_OV05	:007 0x6011:007 Ch01Intensity2_OV06	:008 0x6011:008 Ch01Intensity2_OV07

Fig. 81 Mapping for intensity 2 of DIST2

0x1A80	Ch01Shutter TxPDOMap OV1			
	:001 0x6030:001 Ch01Shutter_OV00			
0x1A81	Ch01Shutter TxPDOMap OV2			
	:001 0x6030:001 Ch01Shutter_OV00	:002 0x6030:002 Ch01Shutter_OV01		
0x1A82	Ch01Shutter TxPDOMap OV4			
	:001 0x6030:001 Ch01Shutter_OV00	:002 0x6030:002 Ch01Shutter_OV01	:003 0x6030:003 Ch01Shutter_OV02	:004 0x6030:004 Ch01Shutter_OV03
0x1A83	Ch01Shutter TxPDOMap OV8			
	:001 0x6030:001 Ch01Shutter_OV00	:002 0x6030:002 Ch01Shutter_OV01	:003 0x6030:003 Ch01Shutter_OV02	:004 0x6030:004 Ch01Shutter_OV03
	:005 0x6030:005 Ch01Shutter_OV04	:006 0x6030:006 Ch01Shutter_OV05	:007 0x6030:007 Ch01Shutter_OV06	:008 0x6030:008 Ch01Shutter_OV07

Fig. 82 Mapping for exposure time

0x1AC0	Ch01Encoder TxPDOMap OV1			
	:001 0x6050:001 Encoder1_OV00	:002 0x6051:001 Encoder2_OV00	:003 0x6052:001 Encoder3_OV00	
0x1AC1	Ch01Encoder TxPDOMap OV2			
	:001 0x6050:001 Encoder1_OV00	:003 0x6051:001 Encoder2_OV00	:005 0x6052:001 Encoder3_OV00	
0x1AC2	Ch01Encoder TxPDOMap OV4			
	:001 0x6050:001 Encoder1_OV00	:005 0x6051:001 Encoder2_OV00	:009 0x6052:001 Encoder3_OV00	
	:002 0x6050:002 Encoder1_OV01	:006 0x6051:002 Encoder2_OV01	:010 0x6052:002 Encoder3_OV01	
	:003 0x6050:003 Encoder1_OV02	:007 0x6051:003 Encoder2_OV02	:011 0x6052:003 Encoder3_OV02	
0x1AC3	Ch01Encoder TxPDOMap OV8			
	:001 0x6050:001 Encoder1_OV00	:009 0x6051:001 Encoder2_OV00	:017 0x6052:001 Encoder3_OV00	
	:002 0x6050:002 Encoder1_OV01	:010 0x6051:002 Encoder2_OV01	:018 0x6052:002 Encoder3_OV01	
	:003 0x6050:003 Encoder1_OV02	:011 0x6051:003 Encoder2_OV02	:019 0x6052:003 Encoder3_OV02	
	:004 0x6050:004 Encoder1_OV03	:012 0x6051:004 Encoder2_OV03	:020 0x6052:004 Encoder3_OV03	
	:005 0x6050:005 Encoder1_OV04	:013 0x6051:005 Encoder2_OV04	:021 0x6052:005 Encoder3_OV04	
	:006 0x6050:006 Encoder1_OV05	:014 0x6051:006 Encoder2_OV05	:022 0x6052:006 Encoder3_OV05	
	:007 0x6050:007 Encoder1_OV06	:015 0x6051:007 Encoder2_OV06	:023 0x6052:007 Encoder3_OV06	
:008 0x6050:008 Encoder1_OV07	:016 0x6051:008 Encoder2_OV07	:024 0x6052:008 Encoder3_OV07		

Fig. 83 Mapping for encoders 1 to 3

0x1AE0	Counter TxPDOMap OV1			
	:001 0x7000:001 Counter_OV00			
0x1AE1	Counter TxPDOMap OV2			
	:001 0x7000:001 Counter_OV00	:002 0x7000:002 Counter_OV01		
0x1AE2	Counter TxPDOMap OV4			
	:001 0x7000:001 Counter_OV00	:002 0x7000:002 Counter_OV01	:003 0x7000:003 Counter_OV02	:004 0x7000:004 Counter_OV03
0x1AE3	Counter TxPDOMap OV8			
	:001 0x7000:001 Counter_OV00	:002 0x7000:002 Counter_OV01	:003 0x7000:003 Counter_OV02	:004 0x7000:004 Counter_OV03
	:005 0x7000:005 Counter_OV04	:006 0x7000:006 Counter_OV05	:007 0x7000:007 Counter_OV06	:008 0x7000:008 Counter_OV07

Fig. 84 Mapping for measured value counter

0x1AE8	Time stamp TxPDOMap OV1			
	:001 0x7001:001 Time stamp_OV00			
0x1AE9	Time stamp TxPDOMap OV2			
	:001 0x7001:001 Time stamp_OV00	:002 0x7001:002 Time stamp_OV01		
0x1AEA	Time stamp TxPDOMap OV4			
	:001 0x7001:001 Time stamp_OV00	:002 0x7001:002 Time stamp_OV01	:003 0x7001:003 Time stamp_OV02	:004 0x7001:004 Time stamp_OV03
0x1AEB	Time stamp TxPDOMap OV8			
	:001 0x7001:001 Time stamp_OV00	:002 0x7001:002 Time stamp_OV01	:003 0x7001:003 Time stamp_OV02	:004 0x7001:004 Time stamp_OV03
	:005 0x7001:005 Time stamp_OV04	:006 0x7001:006 Time stamp_OV05	:007 0x7001:007 Time stamp_OV06	:008 0x7001:008 Time stamp_OV07

Fig. 85 Mapping for time information

0x1AF0	Frequency TxPDOMap OV1			
	:001 0x7002:001 Frequency_OV00			
0x1AF1	Frequency TxPDOMap OV2			
	:001 0x7002:001 Frequency_OV00	:002 0x7002:002 Frequency_OV01		
0x1AF2	Frequency TxPDOMap OV4			
	:001 0x7002:001 Frequency_OV00	:002 0x7002:002 Frequency_OV01	:003 0x7002:003 Frequency_OV02	:004 0x7002:004 Frequency_OV03
0x1AF3	Frequency TxPDOMap OV8			
	:001 0x7002:001 Frequency_OV00	:002 0x7002:002 Frequency_OV01	:003 0x7002:003 Frequency_OV02	:004 0x7002:004 Frequency_OV03
	:005 0x7002:005 Frequency_OV04	:006 0x7002:006 Frequency_OV05	:007 0x7002:007 Frequency_OV06	:008 0x7002:008 Frequency_OV07

Fig. 86 Mapping for measuring frequency

0x1B00	User calc output 01 TxPDOMap OV1			
	:001 0x7C00:001 User calc 01_OV00			
0x1B01	User calc output 01 TxPDOMap OV2			
	:001 0x7C00:001 User calc 01_OV00	:002 0x7C00:002 User calc 01_OV01		
0x1B02	User calc output 01 TxPDOMap OV4			
	:001 0x7C00:001 User calc 01_OV00	:002 0x7C00:002 User calc 01_OV01	:003 0x7C00:003 User calc 01_OV02	:004 0x7C00:004 User calc 01_OV03
0x1B03	User calc output 01 TxPDOMap OV8			
	:001 0x7C00:001 User calc 01_OV00	:002 0x7C00:002 User calc 01_OV01	:003 0x7C00:003 User calc 01_OV02	:004 0x7C00:004 User calc 01_OV03
	:005 0x7C00:005 User calc 01_OV04	:006 0x7C00:006 User calc 01_OV05	:007 0x7C00:007 User calc 01_OV06	:008 0x7C00:008 User calc 01_OV07

Fig. 87 Mapping for calculation program 1

0x1B08	User calc output 02 TxPDOMap OV1			
	:001 0x7C01:001 User calc 02_OV00			
0x1B09	User calc output 02 TxPDOMap OV2			
	:001 0x7C01:001 User calc 02_OV00	:002 0x7C01:002 User calc 02_OV01		
0x1B0A	User calc output 02 TxPDOMap OV4			
	:001 0x7C01:001 User calc 02_OV00	:002 0x7C01:002 User calc 02_OV01	:003 0x7C01:003 User calc 02_OV02	:004 0x7C01:004 User calc 02_OV03
0x1B0B	User calc output 02 TxPDOMap OV8			
	:001 0x7C01:001 User calc 02_OV00	:002 0x7C01:002 User calc 02_OV01	:003 0x7C01:003 User calc 02_OV02	:004 0x7C01:004 User calc 02_OV03
	:005 0x7C01:005 User calc 02_OV04	:006 0x7C01:006 User calc 02_OV05	:007 0x7C01:007 User calc 02_OV06	:008 0x7C01:008 User calc 02_OV07

Fig. 88 Mapping for calculation program 2

0x1B10	User calc output 03 TxPDOMap OV1			
	:001 0x7C02:001 User calc 03_OV00			
0x1B11	User calc output 03 TxPDOMap OV2			
	:001 0x7C02:001 User calc 03_OV00	:002 0x7C02:002 User calc 03_OV01		
0x1B12	User calc output 03 TxPDOMap OV4			
	:001 0x7C02:001 User calc 03_OV00	:002 0x7C02:002 User calc 03_OV01	:003 0x7C02:003 User calc 03_OV02	:004 0x7C02:004 User calc 03_OV03
0x1B13	User calc output 03 TxPDOMap OV8			
	:001 0x7C02:001 User calc 03_OV00	:002 0x7C02:002 User calc 03_OV01	:003 0x7C02:003 User calc 03_OV02	:004 0x7C02:004 User calc 03_OV03
	:005 0x7C02:005 User calc 03_OV04	:006 0x7C02:006 User calc 03_OV05	:007 0x7C02:007 User calc 03_OV06	:008 0x7C02:008 User calc 03_OV07

Fig. 89 Mapping for calculation program 3

0x1B18	User calc output 04 TxPDOMap OV1			
	:001 0x7C03:001 User calc 04_OV00			
0x1B19	User calc output 04 TxPDOMap OV2			
	:001 0x7C03:001 User calc 04_OV00	:002 0x7C03:002 User calc 04_OV01		
0x1B1A	User calc output 04 TxPDOMap OV4			
	:001 0x7C03:001 User calc 04_OV00	:002 0x7C03:002 User calc 04_OV01	:003 0x7C03:003 User calc 04_OV02	:004 0x7C03:004 User calc 04_OV03
0x1B1B	User calc output 04 TxPDOMap OV8			
	:001 0x7C03:001 User calc 04_OV00	:002 0x7C03:002 User calc 04_OV01	:003 0x7C03:003 User calc 04_OV02	:004 0x7C03:004 User calc 04_OV03
	:005 0x7C03:005 User calc 04_OV04	:006 0x7C03:006 User calc 04_OV05	:007 0x7C03:007 User calc 04_OV06	:008 0x7C03:008 User calc 04_OV07

Fig. 90 Mapping for calculation program 4

0x1B20	User calc output 05 TxPDOMap OV1			
	:001 0x7C04:001 User calc 05_OV00			
0x1B21	User calc output 05 TxPDOMap OV2			
	:001 0x7C04:001 User calc 05_OV00	:002 0x7C04:002 User calc 05_OV01		
0x1B22	User calc output 05 TxPDOMap OV4			
	:001 0x7C04:001 User calc 05_OV00	:002 0x7C04:002 User calc 05_OV01	:003 0x7C04:003 User calc 05_OV02	:004 0x7C04:004 User calc 05_OV03
0x1B23	User calc output 05 TxPDOMap OV8			
	:001 0x7C04:001 User calc 05_OV00	:002 0x7C04:002 User calc 05_OV01	:003 0x7C04:003 User calc 05_OV02	:004 0x7C04:004 User calc 05_OV03
	:005 0x7C04:005 User calc 05_OV04	:006 0x7C04:006 User calc 05_OV05	:007 0x7C04:007 User calc 05_OV06	:008 0x7C04:008 User calc 05_OV07

Fig. 91 Mapping for calculation program 5

0x1B28	User calc output 06 and 07 TxPDOMap OV1			
	:001 0x7C05:001 User calc 06_OV00			
	:002 0x7C06:001 User calc 07_OV00			
0x1B29	User calc output 06 and 07 TxPDOMap OV2			
	:001 0x7C05:001 User calc 06_OV00	:002 0x7C05:002 User calc 06_OV01		
	:003 0x7C06:001 User calc 07_OV00	:004 0x7C06:002 User calc 07_OV01		
0x1B2A	User calc output 06 and 07 TxPDOMap OV4			
	:001 0x7C05:001 User calc 06_OV00	:002 0x7C05:002 User calc 06_OV01	:003 0x7C05:003 User calc 06_OV02	:004 0x7C05:004 User calc 06_OV03
	:005 0x7C06:001 User calc 07_OV00	:006 0x7C06:002 User calc 07_OV01	:007 0x7C06:003 User calc 07_OV02	:008 0x7C06:004 User calc 07_OV03
0x1B2B	User calc output 06 and 07 TxPDOMap OV8			
	:001 0x7C05:001 User calc 06_OV00	:002 0x7C05:002 User calc 06_OV01	:003 0x7C05:003 User calc 06_OV02	:004 0x7C05:004 User calc 06_OV03
	:005 0x7C05:005 User calc 06_OV04	:006 0x7C05:006 User calc 06_OV05	:007 0x7C05:007 User calc 06_OV06	:008 0x7C05:008 User calc 06_OV07
	:009 0x7C06:001 User calc 07_OV00	:010 0x7C06:002 User calc 07_OV01	:011 0x7C06:003 User calc 07_OV02	:012 0x7C06:004 User calc 07_OV03
	:013 0x7C06:005 User calc 07_OV04	:014 0x7C06:006 User calc 07_OV05	:015 0x7C06:007 User calc 07_OV06	:016 0x7C06:008 User calc 07_OV07

Fig. 92 Mapping for calculation programs 6 and 7

0x1B30	User calc output 08 and 09 TxPDOMap OV1			
	:001 0x7C07:001 User calc 08_OV00			
	:002			
	0x7C08:001 User calc 09_OV00			
0x1B31	User calc output 08 and 09 TxPDOMap OV2			
	:001 0x7C07:001 User calc 08_OV00	:002 0x7C07:002 User calc 08_OV01		
	:003 0x7C08:001 User calc 09_OV00	:004 0x7C08:002 User calc 09_OV01		
0x1B32	User calc output 08 and 09 TxPDOMap OV4			
	:001 0x7C07:001 User calc 08_OV00	:002 0x7C07:002 User calc 08_OV01	:003 0x7C07:003 User calc 08_OV02	:004 0x7C07:004 User calc 08_OV03
	:005 0x7C08:001 User calc 09_OV00	:006 0x7C08:002 User calc 09_OV01	:007 0x7C08:003 User calc 09_OV02	:008 0x7C08:004 User calc 09_OV03
0x1B33	User calc output 08 and 09 TxPDOMap OV8			
	:001 0x7C07:001 User calc 08_OV00	:002 0x7C07:002 User calc 08_OV01	:003 0x7C07:003 User calc 08_OV02	:004 0x7C07:004 User calc 08_OV03
	:005 0x7C07:005 User calc 08_OV04	:006 0x7C07:006 User calc 08_OV05	:007 0x7C07:007 User calc 08_OV06	:008 0x7C07:008 User calc 08_OV07
	:009 0x7C08:001 User calc 09_OV00	:010 0x7C08:002 User calc 09_OV01	:011 0x7C08:003 User calc 09_OV02	:012 0x7C08:004 User calc 09_OV03
	:013 0x7C08:005 User calc 09_OV04	:014 0x7C08:006 User calc 09_OV05	:015 0x7C08:007 User calc 09_OV06	:016 0x7C08:008 User calc 09_OV07

Fig. 93 Mapping for calculation programs 8 and 9

0x1B38	User calc output 10 and 11 TxPDOMap OV1			
	:001 0x7C09:001 User calc 10_OV00			
	:002			
	0x7C0A:001 User calc 11_OV00			
0x1B39	User calc output 10 and 11 TxPDOMap OV2			
	:001 0x7C09:001 User calc 10_OV00	:002 0x7C09:002 User calc 10_OV01		
	:003 0x7C0A:001 User calc 11_OV00	:004 0x7C0A:002 User calc 11_OV01		
0x1B3A	User calc output 10 and 11 TxPDOMap OV4			
	:001 0x7C09:001 User calc 10_OV00	:002 0x7C09:002 User calc 10_OV01	:003 0x7C09:003 User calc 10_OV02	:004 0x7C09:004 User calc 10_OV03
	:005 0x7C0A:001 User calc 11_OV00	:006 0x7C0A:002 User calc 11_OV01	:007 0x7C0A:003 User calc 11_OV02	:008 0x7C0A:004 User calc 11_OV03
0x1B3B	User calc output 10 and 11 TxPDOMap OV8			
	:001 0x7C09:001 User calc 10_OV00	:002 0x7C09:002 User calc 10_OV01	:003 0x7C09:003 User calc 10_OV02	:004 0x7C09:004 User calc 10_OV03
	:005 0x7C09:005 User calc 10_OV004	:006 0x7C09:006 User calc 10_OV05	:007 0x7C09:007 User calc 10_OV06	:008 0x7C09:008 User calc 10_OV07
	:009 0x7C0A:001 User calc 11_OV00	:010 0x7C0A:002 User calc 11_OV01	:011 0x7C0A:003 User calc 11_OV02	:012 0x7C0A:004 User calc 11_OV03
	:013 0x7C0A:005 User calc 11_OV04	:014 0x7C0A:006 User calc 11_OV05	:015 0x7C0A:007 User calc 11_OV06	:016 0x7C0A:008 User calc 11_OV07

Fig. 94 Mapping for calculation programs 10 and 11

0x1B40	User calc output 12 and 13 TxPDOMap OV1			
	:001 0x7C0B:001 User calc 12_OV00			
	:002 0x7C0C:001 User calc 13_OV00			
0x1B41	User calc output 12 and 13 TxPDOMap OV2			
	:001 0x7C0B:001 User calc 12_OV00	:002 0x7C0B:002 User calc 12_OV01		
0x1B42	User calc output 12 and 13 TxPDOMap OV4			
	:001 0x7C0B:001 User calc 12_OV00	:002 0x7C0B:002 User calc 12_OV01	:003 0x7C0B:003 User calc 12_OV02	:004 0x7C0B:004 User calc 12_OV03
0x1B43	User calc output 12 and 13 TxPDOMap OV8			
	:001 0x7C0B:001 User calc 12_OV00	:002 0x7C0B:002 User calc 12_OV01	:003 0x7C0B:003 User calc 12_OV02	:004 0x7C0B:004 User calc 12_OV03
	:005 0x7C0B:005 User calc 12_OV004	:006 0x7C0B:006 User calc 12_OV05	:007 0x7C0B:007 User calc 12_OV06	:008 0x7C0B:008 User calc 12_OV07
	:009 0x7C0C:001 User calc 13_OV00	:010 0x7C0C:002 User calc 13_OV01	:011 0x7C0C:003 User calc 13_OV02	:012 0x7C0C:004 User calc 13_OV03
0x1B44	User calc output 14 and 15 TxPDOMap OV1			
	:001 0x7C0D:001 User calc 14_OV00			
	:002 0x7C0E:001 User calc 15_OV00			
	User calc output 14 and 15 TxPDOMap OV2			
0x1B49	User calc output 14 and 15 TxPDOMap OV2			
	:001 0x7C0D:001 User calc 14_OV00	:002 0x7C0D:002 User calc 14_OV01		
0x1B4A	User calc output 14 and 15 TxPDOMap OV4			
	:001 0x7C0D:001 User calc 14_OV00	:002 0x7C0D:002 User calc 14_OV01	:003 0x7C0D:003 User calc 14_OV02	:004 0x7C0D:004 User calc 14_OV03
0x1B4B	User calc output 14 and 15 TxPDOMap OV8			
	:001 0x7C0D:001 User calc 14_OV00	:002 0x7C0D:002 User calc 14_OV01	:003 0x7C0D:003 User calc 14_OV02	:004 0x7C0D:004 User calc 14_OV03
	:005 0x7C0D:005 User calc 14_OV004	:006 0x7C0D:006 User calc 14_OV05	:007 0x7C0D:007 User calc 14_OV06	:008 0x7C0D:008 User calc 14_OV07
	:009 0x7C0E:001 User calc 15_OV00	:010 0x7C0E:002 User calc 15_OV01	:011 0x7C0E:003 User calc 15_OV02	:012 0x7C0E:004 User calc 15_OV03
0x1B4C	User calc output 14 and 15 TxPDOMap OV8			
	:013 0x7C0E:005 User calc 15_OV04	:014 0x7C0E:006 User calc 15_OV05	:015 0x7C0E:007 User calc 15_OV06	:016 0x7C0E:008 User calc 15_OV07

Fig. 95 Mapping for calculation programs 12 and 13

0x1B48	User calc output 14 and 15 TxPDOMap OV1			
	:001 0x7C0D:001 User calc 14_OV00			
	:002 0x7C0E:001 User calc 15_OV00			
0x1B49	User calc output 14 and 15 TxPDOMap OV2			
	:001 0x7C0D:001 User calc 14_OV00	:002 0x7C0D:002 User calc 14_OV01		
0x1B4A	User calc output 14 and 15 TxPDOMap OV4			
	:001 0x7C0D:001 User calc 14_OV00	:002 0x7C0D:002 User calc 14_OV01	:003 0x7C0D:003 User calc 14_OV02	:004 0x7C0D:004 User calc 14_OV03
0x1B4B	User calc output 14 and 15 TxPDOMap OV8			
	:001 0x7C0D:001 User calc 14_OV00	:002 0x7C0D:002 User calc 14_OV01	:003 0x7C0D:003 User calc 14_OV02	:004 0x7C0D:004 User calc 14_OV03
	:005 0x7C0D:005 User calc 14_OV004	:006 0x7C0D:006 User calc 14_OV05	:007 0x7C0D:007 User calc 14_OV06	:008 0x7C0D:008 User calc 14_OV07
	:009 0x7C0E:001 User calc 15_OV00	:010 0x7C0E:002 User calc 15_OV01	:011 0x7C0E:003 User calc 15_OV02	:012 0x7C0E:004 User calc 15_OV03
0x1B4C	User calc output 14 and 15 TxPDOMap OV8			
	:013 0x7C0E:005 User calc 15_OV04	:014 0x7C0E:006 User calc 15_OV05	:015 0x7C0E:007 User calc 15_OV06	:016 0x7C0E:008 User calc 15_OV07

Fig. 96 Mapping for calculation programs 14 and 15

0x1B50	User calc output 16 and 17 TxPDOMap OV1			
	:001 0x7C0F:001 User calc 16_OV00			
	:002			
	0x7C10:001 User calc 17_OV00			
0x1B51	User calc output 16 and 17 TxPDOMap OV2			
	:001 0x7C0F:001 User calc 16_OV00	:002 0x7C0F:002 User calc 16_OV01		
	:003 0x7C10:001 User calc 17_OV00	:004 0x7C10:002 User calc 17_OV01		
0x1B52	User calc output 16 and 17 TxPDOMap OV4			
	:001 0x7C0F:001 User calc 16_OV00	:002 0x7C0F:002 User calc 16_OV01	:003 0x7C0F:003 User calc 16_OV02	:004 0x7C0F:004 User calc 16_OV03
	:005 0x7C10:001 User calc 17_OV00	:006 0x7C10:002 User calc 17_OV01	:007 0x7C10:003 User calc 17_OV02	:008 0x7C10:004 User calc 17_OV03
0x1B53	User calc output 16 and 17 TxPDOMap OV8			
	:001 0x7C0F:001 User calc 16_OV00	:002 0x7C0F:002 User calc 16_OV01	:003 0x7C0F:003 User calc 16_OV02	:004 0x7C0F:004 User calc 16_OV03
	:005 0x7C0F:005 User calc 16_OV004	:006 0x7C0F:006 User calc 16_OV05	:007 0x7C0F:007 User calc 16_OV06	:008 0x7C0F:008 User calc 16_OV07
	:009 0x7C10:001 User calc 17_OV00	:010 0x7C10:002 User calc 17_OV01	:011 0x7C10:003 User calc 17_OV02	:012 0x7C10:004 User calc 17_OV03
	:013 0x7C10:005 User calc 17_OV04	:014 0x7C10:006 User calc 17_OV05	:015 0x7C10:007 User calc 17_OV06	:016 0x7C10:008 User calc 17_OV07

Fig. 97 Mapping for calculation programs 16 and 17

0x1B58	User calc output 18 and 19 TxPDOMap OV1			
	:001 0x7C11:001 User calc 18_OV00			
	:002			
	0x7C12:001 User calc 19_OV00			
0x1B59	User calc output 18 and 19 TxPDOMap OV2			
	:001 0x7C11:001 User calc 18_OV00	:002 0x7C11:002 User calc 18_OV01		
	:003 0x7C12:001 User calc 19_OV00	:004 0x7C12:002 User calc 19_OV01		
0x1B5A	User calc output 18 and 17 TxPDOMap OV4			
	:001 0x7C11:001 User calc 18_OV00	:002 0x7C11:002 User calc 18_OV01	:003 0x7C11:003 User calc 18_OV02	:004 0x7C11:004 User calc 16_OV03
	:005 0x7C12:001 User calc 19_OV00	:006 0x7C12:002 User calc 19_OV01	:007 0x7C12:003 User calc 19_OV02	:008 0x7C12:004 User calc 17_OV03
0x1B5B	User calc output 18 and 17 TxPDOMap OV8			
	:001 0x7C11F:001 User calc 18_OV00	:002 0x7C11:002 User calc 18_OV01	:003 0x7C11:003 User calc 18_OV02	:004 0x7C11:004 User calc 18_OV03
	:005 0x7C11:005 User calc 18_OV004	:006 0x7C11:006 User calc 18_OV05	:007 0x7C11:007 User calc 18_OV06	:008 0x7C11:008 User calc 18_OV07
	:009 0x7C12:001 User calc 19_OV00	:010 0x7C12:002 User calc 19_OV01	:011 0x7C12:003 User calc 19_OV02	:012 0x7C12:004 User calc 19_OV03
	:013 0x7C12:005 User calc 19_OV04	:014 0x7C12:006 User calc 19_OV05	:015 0x7C12:007 User calc 19_OV06	:016 0x7C12:008 User calc 19_OV07

Fig. 98 Mapping for calculation programs 18 and 19

8.3.1.8 TxPDO Mapping IFD2415

0x1A00	Ch01Dist1 TxPDOMap OV1			
	:001 0x6000:001 Ch01Dist1_OV00			
0x1A01	Ch01Dist1 TxPDOMap OV2			
	:001 0x6000:001 Ch01Dist1_OV00	:002 0x6000:002 Ch01Dist1_OV01		
0x1A02	Ch01Dist1 TxPDOMap OV4			
	:001 0x6000:001 Ch01Dist1_OV00	:002 0x6000:002 Ch01Dist1_OV01	:003 0x6000:003 Ch01Dist1_OV02	:004 0x6000:004 Ch01Dist1_OV03
0x1A03	Ch01Dist1 TxPDOMap OV8			
	:001 0x6000:001 Ch01Dist1_OV00	:002 0x6000:002 Ch01Dist1_OV01	:003 0x6000:003 Ch01Dist1_OV02	:004 0x6000:004 Ch01Dist1_OV03
	:005 0x6000:005 Ch01Dist1_OV04	:006 0x6000:006 Ch01Dist1_OV05	:007 0x6000:007 Ch01Dist1_OV06	:008 0x6000:008 Ch01Dist1_OV07

Fig. 99 Mapping for distance value DIST1

0x1A10	Ch01Dist2 TxPDOMap OV1			
	:001 0x6001:001 Ch01Dist2_OV00			
0x1A11	Ch01Dist2 TxPDOMap OV2			
	:001 0x6001:001 Ch01Dist2_OV00	:002 0x6001:002 Ch01Dist2_OV01		
0x1A12	Ch01Dist2 TxPDOMap OV4			
	:001 0x6001:001 Ch01Dist2_OV00	:002 0x6001:002 Ch01Dist2_OV01	:003 0x6001:003 Ch01Dist2_OV02	:004 0x6001:004 Ch01Dist2_OV03
0x1A13	Ch01Dist2 TxPDOMap OV8			
	:001 0x6001:001 Ch01Dist2_OV00	:002 0x6001:002 Ch01Dist2_OV01	:003 0x6001:003 Ch01Dist2_OV02	:004 0x6001:004 Ch01Dist2_OV03
	:005 0x6001:005 Ch01Dist2_OV04	:006 0x6001:006 Ch01Dist2_OV05	:007 0x6001:007 Ch01Dist2_OV06	:008 0x6001:008 Ch01Dist2_OV07

Fig. 100 Mapping for distance value DIST2

0x1A20	Ch01Dist3 bis Dist6 TxPDOMap OV1			
	:001 0x6002:001 Ch01Dist3_OV00	:002 0x6003:001 Ch01Dist4_OV00	:003 0x6004:001 Ch01Dist5_OV00	:004 0x6005:001 Ch01Dist6_OV00
0x1A21	Ch01Dist3 bis Dist6 TxPDOMap OV2			
	:001 0x6002:001 Ch01Dist3_OV00	:003 0x6003:001 Ch01Dist4_OV00	:005 0x6004:001 Ch01Dist5_OV00	:007 0x6005:001 Ch01Dist6_OV00
	:002 0x6002:002 Ch01Dist3_OV01	:004 0x6003:002 Ch01Dist4_OV01	:006 0x6004:002 Ch01Dist5_OV01	:008 0x6005:002 Ch01Dist6_OV01
0x1A22	Ch01Dist3 bis Dist6 TxPDOMap OV4			
	:001 0x6002:001 Ch01Dist3_OV00	:005 0x6003:001 Ch01Dist4_OV00	:009 0x6004:001 Ch01Dist5_OV00	:013 0x6005:001 Ch01Dist6_OV00
	:002 0x6002:002 Ch01Dist3_OV01	:006 0x6003:002 Ch01Dist4_OV01	:010 0x6004:002 Ch01Dist5_OV01	:014 0x6005:002 Ch01Dist6_OV01
	:003 0x6002:003 Ch01Dist3_OV02	:007 0x6003:003 Ch01Dist4_OV02	:011 0x6004:003 Ch01Dist5_OV02	:015 0x6005:003 Ch01Dist6_OV02
	:004 0x6002:004 Ch01Dist3_OV03	:008 0x6003:004 Ch01Dist4_OV03	:012 0x6004:004 Ch01Dist5_OV03	:016 0x6005:004 Ch01Dist6_OV03
0x1A23	Ch01Dist3 bis Dist6 TxPDOMap OV8			
	:001 0x6002:001 Ch01Dist3_OV00	:009 0x6003:001 Ch01Dist4_OV00	:017 0x6004:001 Ch01Dist5_OV00	:025 0x6005:001 Ch01Dist6_OV00
	:002 0x6002:002 Ch01Dist3_OV01	:010 0x6003:002 Ch01Dist4_OV01	:018 0x6004:002 Ch01Dist5_OV01	:026 0x6005:002 Ch01Dist6_OV01
	:003 0x6002:003 Ch01Dist3_OV02	:011 0x6003:003 Ch01Dist4_OV02	:019 0x6004:003 Ch01Dist5_OV02	:027 0x6005:003 Ch01Dist6_OV02
	:004 0x6002:004 Ch01Dist3_OV03	:012 0x6003:004 Ch01Dist4_OV03	:020 0x6004:004 Ch01Dist5_OV03	:028 0x6005:004 Ch01Dist6_OV03
	:005 0x6002:005 Ch01Dist3_OV04	:013 0x6003:005 Ch01Dist4_OV04	:021 0x6004:005 Ch01Dist5_OV04	:029 0x6005:005 Ch01Dist6_OV04
	:006 0x6002:006 Ch01Dist3_OV05	:014 0x6003:006 Ch01Dist4_OV05	:022 0x6004:006 Ch01Dist5_OV05	:030 0x6005:006 Ch01Dist6_OV05
	:007 0x6002:007 Ch01Dist3_OV06	:015 0x6003:007 Ch01Dist4_OV06	:023 0x6004:007 Ch01Dist5_OV06	:031 0x6005:007 Ch01Dist6_OV06
	:008 0x6002:008 Ch01Dist3_OV07	:016 0x6003:008 Ch01Dist4_OV07	:024 0x6004:008 Ch01Dist5_OV07	:032 0x6005:008 Ch01Dist6_OV07

Fig. 101 Mapping for distance values DIST3 to DIST6

0x1A30	Ch01Intensity1 TxPDOMap OV1			
	:001 0x6010:001 Ch01Intensity1_OV00			
0x1A31	Ch01Intensity1 TxPDOMap OV2			
	:001 0x6010:001 Ch01Intensity1_OV00	:002 0x6010:002 Ch01Intensity1_OV01		
0x1A32	Ch01Intensity1 TxPDOMap OV4			
	:001 0x6010:001 Ch01Intensity1_OV00	:002 0x6010:002 Ch01Intensity1_OV01	:003 0x6010:003 Ch01Intensity1_OV02	:004 0x6010:004 Ch01Intensity1_OV03
0x1A33	Ch01Intensity1 TxPDOMap OV8			
	:001 0x6010:001 Ch01Intensity1_OV00	:002 0x6010:002 Ch01Intensity1_OV01	:003 0x6010:003 Ch01Intensity1_OV02	:004 0x6010:004 Ch01Intensity1_OV03
	:005 0x6010:005 Ch01Intensity1_OV04	:006 0x6010:006 Ch01Intensity1_OV05	:007 0x6010:007 Ch01Intensity1_OV06	:008 0x6010:008 Ch01Intensity1_OV07

Fig. 102 Mapping for intensity 1 of DIST1

0x1A40	Ch01Intensity2 TxPDOMap OV1			
	:001 0x6011:001 Ch01Intensity2_OV00			
0x1A41	Ch01Intensity2 TxPDOMap OV2			
	:001 0x6011:001 Ch01Intensity2_OV00	:002 0x6011:002 Ch01Intensity2_OV01		
0x1A42	Ch01Intensity2 TxPDOMap OV4			
	:001 0x6011:001 Ch01Intensity2_OV00	:002 0x6011:002 Ch01Intensity2_OV01	:003 0x6011:003 Ch01Intensity2_OV02	:004 0x6011:004 Ch01Intensity2_OV03
0x1A43	Ch01Intensity2 TxPDOMap OV8			
	:001 0x6011:001 Ch01Intensity2_OV00	:002 0x6011:002 Ch01Intensity2_OV01	:003 0x6011:003 Ch01Intensity2_OV02	:004 0x6011:004 Ch01Intensity2_OV03
	:005 0x6011:005 Ch01Intensity2_OV04	:006 0x6011:006 Ch01Intensity2_OV05	:007 0x6011:007 Ch01Intensity2_OV06	:008 0x6011:008 Ch01Intensity2_OV07

Fig. 103 Mapping for intensity 2 of DIST2

0x1A50	Channel 1 intensity 3 bis 6 TxPDOMap OV1			
	:001 0x6012:001 Intensity3_OV00	:002 0x6013:001 Intensity4_OV00	:003 0x6014:001 Intensity5_OV00	:004 0x6015:001 Intensity6_OV00
0x1A51	Channel 1 intensity 3 bis 6 OV2			
	:001 0x6012:001 Intensity3_OV00	:003 0x6013:001 Intensity4_OV00	:005 0x6014:001 Intensity5_OV00	:007 0x6015:001 Intensity6_OV00
	:002 0x6012:002 Intensity3_OV01	:004 0x6013:002 Intensity4_OV01	:006 0x6014:002 Intensity5_OV01	:008 0x6015:002 Intensity6_OV01
0x1A52	Channel 1 intensity 3 bis 6 OV4			
	:001 0x6012:001 Intensity3_OV00	:005 0x6013:001 Intensity4_OV00	:009 0x6014:001 Intensity5_OV00	:013 0x6015:001 Intensity6_OV00
	:002 0x6012:002 Intensity3_OV01	:006 0x6013:002 Intensity4_OV01	:010 0x6014:002 Intensity5_OV01	:014 0x6015:002 Intensity6_OV01
	:003 0x6012:003 Intensity3_OV02	:007 0x6013:003 Intensity4_OV02	:011 0x6014:003 Intensity5_OV02	:015 0x6015:003 Intensity6_OV02
	:004 0x6012:004 Intensity3_OV03	:008 0x6013:004 Intensity4_OV03	:012 0x6014:004 Intensity5_OV03	:016 0x6015:004 Intensity6_OV03
0x1A53	Channel 1 intensity 3 bis 6 OV8			
	:001 0x6012:001 Intensity3_OV00	:009 0x6013:001 Intensity4_OV00	:017 0x6014:001 Intensity5_OV00	:025 0x6015:001 Intensity6_OV00
	:002 0x6012:002 Intensity3_OV01	:010 0x6013:002 Intensity4_OV01	:018 0x6014:002 Intensity5_OV01	:026 0x6015:002 Intensity6_OV01
	:003 0x6012:003 Intensity3_OV02	:011 0x6013:003 Intensity4_OV02	:019 0x6014:003 Intensity5_OV02	:027 0x6015:003 Intensity6_OV02
	:004 0x6012:004 Intensity3_OV03	:012 0x6013:004 Intensity4_OV03	:020 0x6014:004 Intensity5_OV03	:028 0x6015:004 Intensity6_OV03
	:005 0x6012:005 Intensity3_OV04	:013 0x6013:005 Intensity4_OV04	:021 0x6014:005 Intensity5_OV04	:029 0x6015:005 Intensity6_OV04
	:006 0x6012:006 Intensity3_OV05	:014 0x6013:006 Intensity4_OV05	:022 0x6014:006 Intensity5_OV05	:030 0x6015:006 Intensity6_OV05
	:007 0x6012:007 Intensity3_OV06	:015 0x6013:007 Intensity4_OV06	:023 0x6014:007 Intensity5_OV06	:031 0x6015:007 Intensity6_OV06
	:008 0x6012:008 Intensity3_OV07	:016 0x6013:008 Intensity4_OV07	:024 0x6014:008 Intensity5_OV07	:032 0x6015:008 Intensity6_OV07

Fig. 104 Mapping for intensities 3 to 6 from DIST3 to DIST6

0x1A80	Ch01Shutter TxPDOMap OV1			
	:001 0x6030:001 Ch01Shutter_OV00			
0x1A81	Ch01Shutter TxPDOMap OV2			
	:001 0x6030:001 Ch01Shutter_OV00	:002 0x6030:002 Ch01Shutter_OV01		
0x1A82	Ch01Shutter TxPDOMap OV4			
	:001 0x6030:001 Ch01Shutter_OV00	:002 0x6030:002 Ch01Shutter_OV01	:003 0x6030:003 Ch01Shutter_OV02	:004 0x6030:004 Ch01Shutter_OV03
0x1A83	Ch01Shutter TxPDOMap OV8			
	:001 0x6030:001 Ch01Shutter_OV00	:002 0x6030:002 Ch01Shutter_OV01	:003 0x6030:003 Ch01Shutter_OV02	:004 0x6030:004 Ch01Shutter_OV03
	:005 0x6030:005 Ch01Shutter_OV04	:006 0x6030:006 Ch01Shutter_OV05	:007 0x6030:007 Ch01Shutter_OV06	:008 0x6030:008 Ch01Shutter_OV07

Fig. 105 Mapping for exposure time

0x1A90	CH01 Peak symmetry 1 TxPDOMap OV1			
	:001 0x6060:001 Peak sym 1_OV00			
0x1A91	CH01 Peak symmetry 1 TxPDOMap OV2			
	:001 0x6060:001 Peak sym 1_OV00	:002 0x6060:002 Peak sym 1_OV01		
0x1A92	CH01 Peak symmetry 1 TxPDOMap OV4			
	:001 0x6060:001 Peak sym 1_OV00	:002 0x6060:002 Peak sym 1_OV01	:003 0x6060:003 Peak sym 1_OV02	:004 0x6060:004 Peak sym 1_OV03
0x1A93	CH01 Peak symmetry 1 TxPDOMap OV8			
	:001 0x6060:001 Peak sym 1_OV00	:002 0x6060:002 Peak sym 1_OV01	:003 0x6060:003 Peak sym 1_OV02	:004 0x6060:004 Peak sym 1_OV03
	:005 0x6060:005 Peak sym 1_OV04	:006 0x6060:006 Peak sym 1_OV05	:007 0x6060:007 Peak sym 1_OV06	:008 0x6060:008 Peak sym 1_OV07

Fig. 106 Mapping for peak symmetry 1

0x1AA0	CH01 Peak symmetry 2 TxPDOMap OV1			
	:001 0x6061:001 Peak sym 2_OV00			
0x1AA1	CH01 Peak symmetry 2 TxPDOMap OV2			
	:001 0x6061:001 Peak sym 2_OV00	:002 0x6061:002 Peak sym 2_OV01		
0x1AA2	CH01 Peak symmetry 2 TxPDOMap OV4			
	:001 0x6061:001 Peak sym 2_OV00	:002 0x6061:002 Peak sym 2_OV01	:003 0x6061:003 Peak sym 2_OV02	:004 0x6061:004 Peak sym 2_OV03
0x1AA3	CH01 Peak symmetry 2 TxPDOMap OV8			
	:001 0x6061:001 Peak sym 2_OV00	:002 0x6061:002 Peak sym 2_OV01	:003 0x6061:003 Peak sym 2_OV02	:004 0x6061:004 Peak sym 2_OV03
	:005 0x6061:005 Peak sym 2_OV04	:006 0x6061:006 Peak sym 2_OV05	:007 0x6061:007 Peak sym 2_OV06	:008 0x6061:008 Peak sym 2_OV07

Fig. 107 Mapping for peak symmetry 2

0x1AB0	CH01 Peak symmetry 3 bis 6 TxPDOMap OV1			
	:001 0x6062:001 Peak sym 3_OV00	:002 0x6063:001 Peak sym 4_OV00	:003 0x6064:001 Peak sym 5_OV00	:004 0x6065:001 Peak sym 6_OV00
0x1AB1	CH01 Peak symmetry 3 bis 6 OV2			
	:001 0x6062:001 Peak sym 3_OV00	:003 0x6063:001 Peak sym 4_OV00	:005 0x6064:001 IPeak sym 5_OV00	:007 0x6065:001 Peak sym 6_OV00
	:002 0x6062:002 Peak sym 3_OV01	:004 0x6063:002 Peak sym 4_OV01	:006 0x6064:002 IPeak sym 5_OV01	:008 0x6065:002 Peak sym 6_OV01
0x1AB2	CH01 Peak symmetry 3 bis 6 OV4			
	:001 0x6062:001 Peak sym 3_OV00	:005 0x6063:001 Peak sym 4_OV00	:009 0x6064:001 Peak sym 5_OV00	:013 0x6065:001 Peak sym 6_OV00
	:002 0x6062:002 Peak sym 3_OV01	:006 0x6063:002 Peak sym 4_OV01	:010 0x6064:002 Peak sym 5_OV01	:014 0x6065:002 Peak sym 6_OV01
	:003 0x6062:003 Peak sym 3_OV02	:007 0x6063:003 Peak sym 4_OV02	:011 0x6064:003 Peak sym 5_OV02	:015 0x6065:003 Peak sym 6_OV02
	:004 0x6062:004 Peak sym 3_OV03	:008 0x6063:004 Peak sym 4_OV03	:012 0x6064:004 Peak sym 5_OV03	:016 0x6065:004 Peak sym 6_OV03
0x1AB3	CH01 Peak symmetry 3 bis 6 OV8			
	:001 0x6062:001 Peak sym 3_OV00	:009 0x6063:001 Peak sym 4_OV00	:017 0x6064:001 Peak sym 5_OV00	:025 0x6065:001 Peak sym 6_OV00
	:002 0x6062:002 Peak sym 3_OV01	:010 0x6063:002 Peak sym 4_OV01	:018 0x6064:002 Peak sym 5_OV01	:026 0x6065:002 Peak sym 6_OV01
	:003 0x6062:003 Peak sym 3_OV02	:011 0x6063:003 Peak sym 4_OV02	:019 0x6064:003 Peak sym 5_OV02	:027 0x6065:003 Peak sym 6_OV02
	:004 0x6062:004 Peak sym 3_OV03	:012 0x6063:004 Peak sym 4_OV03	:020 0x6064:004 Peak sym 5_OV03	:028 0x6065:004 Peak sym 6_OV03
	:005 0x6062:005 Peak sym 3_OV04	:013 0x6063:005 Peak sym 4_OV04	:021 0x6064:005 Peak sym 5_OV04	:029 0x6065:005 Peak sym 6_OV04
	:006 0x6062:006 Peak sym 3_OV05	:014 0x6063:006 Peak sym 4_OV05	:022 0x6064:006 Peak sym 5_OV05	:030 0x6065:006 Peak sym 6_OV05
	:007 0x6062:007 Peak sym 3_OV06	:015 0x6063:007 Peak sym 4_OV06	:023 0x6064:007 Peak sym 5_OV06	:031 0x6065:007 Peak sym 6_OV06
	:008 0x6062:008 Peak sym 3_OV07	:016 0x6063:008 Peak sym 4_OV07	:024 0x6064:008 Peak sym 5_OV07	:032 0x6065:008 Peak sym 6_OV07

Fig. 108 Mapping for peak symmetries 3 to 6

0x1AC0	Ch01Encoder TxPDOMap OV1			
	:001 0x6050:001 Encoder1_OV00	:002 0x6051:001 Encoder2_OV00	:003 0x6052:001 Encoder3_OV00	
0x1AC1	Ch01Encoder TxPDOMap OV2			
	:001 0x6050:001 Encoder1_OV00	:003 0x6051:001 Encoder2_OV00	:005 0x6052:001 Encoder3_OV00	
	:002 0x6050:002 Encoder1_OV01	:004 0x6051:002 Encoder2_OV01	:006 0x6052:002 Encoder3_OV01	
0x1AC2	Ch01Encoder TxPDOMap OV4			
	:001 0x6050:001 Encoder1_OV00	:005 0x6051:001 Encoder2_OV00	:009 0x6052:001 Encoder3_OV00	
	:002 0x6050:002 Encoder1_OV01	:006 0x6051:002 Encoder2_OV01	:010 0x6052:002 Encoder3_OV01	
	:003 0x6050:003 Encoder1_OV02	:007 0x6051:003 Encoder2_OV02	:011 0x6052:003 Encoder3_OV02	
0x1AC3	Ch01Encoder TxPDOMap OV8			
	:001 0x6050:001 Encoder1_OV00	:009 0x6051:001 Encoder2_OV00	:017 0x6052:001 Encoder3_OV00	
	:002 0x6050:002 Encoder1_OV01	:010 0x6051:002 Encoder2_OV01	:018 0x6052:002 Encoder3_OV01	
	:003 0x6050:003 Encoder1_OV02	:011 0x6051:003 Encoder2_OV02	:019 0x6052:003 Encoder3_OV02	
	:004 0x6050:004 Encoder1_OV03	:012 0x6051:004 Encoder2_OV03	:020 0x6052:004 Encoder3_OV03	
	:005 0x6050:005 Encoder1_OV04	:013 0x6051:005 Encoder2_OV04	:021 0x6052:005 Encoder3_OV04	
	:006 0x6050:006 Encoder1_OV05	:014 0x6051:006 Encoder2_OV05	:022 0x6052:006 Encoder3_OV05	
	:007 0x6050:007 Encoder1_OV06	:015 0x6051:007 Encoder2_OV06	:023 0x6052:007 Encoder3_OV06	
:008 0x6050:008 Encoder1_OV07	:016 0x6051:008 Encoder2_OV07	:024 0x6052:008 Encoder3_OV07		

Fig. 109 Mapping for encoders 1 to 3

0x1AE0	Counter TxPDOMap OV1			
	:001 0x7000:001 Counter_OV00			
0x1AE1	Counter TxPDOMap OV2			
	:001 0x7000:001 Counter_OV00	:002 0x7000:002 Counter_OV01		
0x1AE2	Counter TxPDOMap OV4			
	:001 0x7000:001 Counter_OV00	:002 0x7000:002 Counter_OV01	:003 0x7000:003 Counter_OV02	:004 0x7000:004 Counter_OV03
0x1AE3	Counter TxPDOMap OV8			
	:001 0x7000:001 Counter_OV00	:002 0x7000:002 Counter_OV01	:003 0x7000:003 Counter_OV02	:004 0x7000:004 Counter_OV03
	:005 0x7000:005 Counter_OV04	:006 0x7000:006 Counter_OV05	:007 0x7000:007 Counter_OV06	:008 0x7000:008 Counter_OV07

Fig. 110 Mapping for measured value counter

0x1AE8	Time stamp TxPDOMap OV1			
	:001 0x7001:001 Time stamp_OV00			
0x1AE9	Time stamp TxPDOMap OV2			
	:001 0x7001:001 Time stamp_OV00	:002 0x7001:002 Time stamp_OV01		
0x1AEA	Time stamp TxPDOMap OV4			
	:001 0x7001:001 Time stamp_OV00	:002 0x7001:002 Time stamp_OV01	:003 0x7001:003 Time stamp_OV02	:004 0x7001:004 Time stamp_OV03
0x1AEB	Time stamp TxPDOMap OV8			
	:001 0x7001:001 Time stamp_OV00	:002 0x7001:002 Time stamp_OV01	:003 0x7001:003 Time stamp_OV02	:004 0x7001:004 Time stamp_OV03
	:005 0x7001:005 Time stamp_OV04	:006 0x7001:006 Time stamp_OV05	:007 0x7001:007 Time stamp_OV06	:008 0x7001:008 Time stamp_OV07

Fig. 111 Mapping for time information

0x1AF0	Frequency TxPDOMap OV1			
	:001 0x7002:001 Frequency_OV00			
0x1AF1	Frequency TxPDOMap OV2			
	:001 0x7002:001 Frequency_OV00	:002 0x7002:002 Frequency_OV01		
0x1AF2	Frequency TxPDOMap OV4			
	:001 0x7002:001 Frequency_OV00	:002 0x7002:002 Frequency_OV01	:003 0x7002:003 Frequency_OV02	:004 0x7002:004 Frequency_OV03
0x1AF3	Frequency TxPDOMap OV8			
	:001 0x7002:001 Frequency_OV00	:002 0x7002:002 Frequency_OV01	:003 0x7002:003 Frequency_OV02	:004 0x7002:004 Frequency_OV03
	:005 0x7002:005 Frequency_OV04	:006 0x7002:006 Frequency_OV05	:007 0x7002:007 Frequency_OV06	:008 0x7002:008 Frequency_OV07

Fig. 112 Mapping for measuring frequency

0x1B00	User calc output 01 TxPDOMap OV1			
	:001 0x7C00:001 User calc 01_OV00			
0x1B01	User calc output 01 TxPDOMap OV2			
	:001 0x7C00:001 User calc 01_OV00	:002 0x7C00:002 User calc 01_OV01		
0x1B02	User calc output 01 TxPDOMap OV4			
	:001 0x7C00:001 User calc 01_OV00	:002 0x7C00:002 User calc 01_OV01	:003 0x7C00:003 User calc 01_OV02	:004 0x7C00:004 User calc 01_OV03
0x1B03	User calc output 01 TxPDOMap OV8			
	:001 0x7C00:001 User calc 01_OV00	:002 0x7C00:002 User calc 01_OV01	:003 0x7C00:003 User calc 01_OV02	:004 0x7C00:004 User calc 01_OV03
	:005 0x7C00:005 User calc 01_OV04	:006 0x7C00:006 User calc 01_OV05	:007 0x7C00:007 User calc 01_OV06	:008 0x7C00:008 User calc 01_OV07

Fig. 113 Mapping for calculation program 1

0x1B08	User calc output 02 TxPDOMap OV1			
	:001 0x7C01:001 User calc 02_OV00			
0x1B09	User calc output 02 TxPDOMap OV2			
	:001 0x7C01:001 User calc 02_OV00	:002 0x7C01:002 User calc 02_OV01		
0x1B0A	User calc output 02 TxPDOMap OV4			
	:001 0x7C01:001 User calc 02_OV00	:002 0x7C01:002 User calc 02_OV01	:003 0x7C01:003 User calc 02_OV02	:004 0x7C01:004 User calc 02_OV03
0x1B0B	User calc output 02 TxPDOMap OV8			
	:001 0x7C01:001 User calc 02_OV00	:002 0x7C01:002 User calc 02_OV01	:003 0x7C01:003 User calc 02_OV02	:004 0x7C01:004 User calc 02_OV03
	:005 0x7C01:005 User calc 02_OV04	:006 0x7C01:006 User calc 02_OV05	:007 0x7C01:007 User calc 02_OV06	:008 0x7C01:008 User calc 02_OV07

Fig. 114 Mapping for calculation program 2

0x1B10	User calc output 03 TxPDOMap OV1			
	:001 0x7C02:001 User calc 03_OV00			
0x1B11	User calc output 03 TxPDOMap OV2			
	:001 0x7C02:001 User calc 03_OV00	:002 0x7C02:002 User calc 03_OV01		
0x1B12	User calc output 03 TxPDOMap OV4			
	:001 0x7C02:001 User calc 03_OV00	:002 0x7C02:002 User calc 03_OV01	:003 0x7C02:003 User calc 03_OV02	:004 0x7C02:004 User calc 03_OV03
0x1B13	User calc output 03 TxPDOMap OV8			
	:001 0x7C02:001 User calc 03_OV00	:002 0x7C02:002 User calc 03_OV01	:003 0x7C02:003 User calc 03_OV02	:004 0x7C02:004 User calc 03_OV03
	:005 0x7C02:005 User calc 03_OV04	:006 0x7C02:006 User calc 03_OV05	:007 0x7C02:007 User calc 03_OV06	:008 0x7C02:008 User calc 03_OV07

Fig. 115 Mapping for calculation program 3

0x1B18	User calc output 04 TxPDOMap OV1			
	:001 0x7C03:001 User calc 04_OV00			
0x1B19	User calc output 04 TxPDOMap OV2			
	:001 0x7C03:001 User calc 04_OV00	:002 0x7C03:002 User calc 04_OV01		
0x1B1A	User calc output 04 TxPDOMap OV4			
	:001 0x7C03:001 User calc 04_OV00	:002 0x7C03:002 User calc 04_OV01	:003 0x7C03:003 User calc 04_OV02	:004 0x7C03:004 User calc 04_OV03
0x1B1B	User calc output 04 TxPDOMap OV8			
	:001 0x7C03:001 User calc 04_OV00	:002 0x7C03:002 User calc 04_OV01	:003 0x7C03:003 User calc 04_OV02	:004 0x7C03:004 User calc 04_OV03
	:005 0x7C03:005 User calc 04_OV04	:006 0x7C03:006 User calc 04_OV05	:007 0x7C03:007 User calc 04_OV06	:008 0x7C03:008 User calc 04_OV07

Fig. 116 Mapping for calculation program 4

0x1B20	User calc output 05 TxPDOMap OV1			
	:001 0x7C04:001 User calc 05_OV00			
0x1B21	User calc output 05 TxPDOMap OV2			
	:001 0x7C04:001 User calc 05_OV00	:002 0x7C04:002 User calc 05_OV01		
0x1B22	User calc output 05 TxPDOMap OV4			
	:001 0x7C04:001 User calc 05_OV00	:002 0x7C04:002 User calc 05_OV01	:003 0x7C04:003 User calc 05_OV02	:004 0x7C04:004 User calc 05_OV03
0x1B23	User calc output 05 TxPDOMap OV8			
	:001 0x7C04:001 User calc 05_OV00	:002 0x7C04:002 User calc 05_OV01	:003 0x7C04:003 User calc 05_OV02	:004 0x7C04:004 User calc 05_OV03
	:005 0x7C04:005 User calc 05_OV04	:006 0x7C04:006 User calc 05_OV05	:007 0x7C04:007 User calc 05_OV06	:008 0x7C04:008 User calc 05_OV07

Fig. 117 Mapping for calculation program 5

0x1B28	User calc output 06 and 07 TxPDOMap OV1			
	:001 0x7C05:001 User calc 06_OV00			
	:002 0x7C06:001 User calc 07_OV00			
0x1B29	User calc output 06 and 07 TxPDOMap OV2			
	:001 0x7C05:001 User calc 06_OV00	:002 0x7C05:002 User calc 06_OV01		
	:003 0x7C06:001 User calc 07_OV00	:004 0x7C06:002 User calc 07_OV01		
0x1B2A	User calc output 06 and 07 TxPDOMap OV4			
	:001 0x7C05:001 User calc 06_OV00	:002 0x7C05:002 User calc 06_OV01	:003 0x7C05:003 User calc 06_OV02	:004 0x7C05:004 User calc 06_OV03
	:005 0x7C06:001 User calc 07_OV00	:006 0x7C06:002 User calc 07_OV01	:007 0x7C06:003 User calc 07_OV02	:008 0x7C06:004 User calc 07_OV03
0x1B2B	User calc output 06 and 07 TxPDOMap OV8			
	:001 0x7C05:001 User calc 06_OV00	:002 0x7C05:002 User calc 06_OV01	:003 0x7C05:003 User calc 06_OV02	:004 0x7C05:004 User calc 06_OV03
	:005 0x7C05:005 User calc 06_OV04	:006 0x7C05:006 User calc 06_OV05	:007 0x7C05:007 User calc 06_OV06	:008 0x7C05:008 User calc 06_OV07
	:009 0x7C06:001 User calc 07_OV00	:010 0x7C06:002 User calc 07_OV01	:011 0x7C06:003 User calc 07_OV02	:012 0x7C06:004 User calc 07_OV03
	:013 0x7C06:005 User calc 07_OV04	:014 0x7C06:006 User calc 07_OV05	:015 0x7C06:007 User calc 07_OV06	:016 0x7C06:008 User calc 07_OV07

Fig. 118 Mapping for calculation programs 6 and 7

0x1B30	User calc output 08 and 09 TxPDOMap OV1			
	:001 0x7C07:001 User calc 08_OV00			
	:002			
	0x7C08:001 User calc 09_OV00			
0x1B31	User calc output 08 and 09 TxPDOMap OV2			
	:001 0x7C07:001 User calc 08_OV00	:002 0x7C07:002 User calc 08_OV01		
	:003 0x7C08:001 User calc 09_OV00	:004 0x7C08:002 User calc 09_OV01		
0x1B32	User calc output 08 and 09 TxPDOMap OV4			
	:001 0x7C07:001 User calc 08_OV00	:002 0x7C07:002 User calc 08_OV01	:003 0x7C07:003 User calc 08_OV02	:004 0x7C07:004 User calc 08_OV03
	:005 0x7C08:001 User calc 09_OV00	:006 0x7C08:002 User calc 09_OV01	:007 0x7C08:003 User calc 09_OV02	:008 0x7C08:004 User calc 09_OV03
0x1B33	User calc output 08 and 09 TxPDOMap OV8			
	:001 0x7C07:001 User calc 08_OV00	:002 0x7C07:002 User calc 08_OV01	:003 0x7C07:003 User calc 08_OV02	:004 0x7C07:004 User calc 08_OV03
	:005 0x7C07:005 User calc 08_OV04	:006 0x7C07:006 User calc 08_OV05	:007 0x7C07:007 User calc 08_OV06	:008 0x7C07:008 User calc 08_OV07
	:009 0x7C08:001 User calc 09_OV00	:010 0x7C08:002 User calc 09_OV01	:011 0x7C08:003 User calc 09_OV02	:012 0x7C08:004 User calc 09_OV03
	:013 0x7C08:005 User calc 09_OV04	:014 0x7C08:006 User calc 09_OV05	:015 0x7C08:007 User calc 09_OV06	:016 0x7C08:008 User calc 09_OV07

Fig. 119 Mapping for calculation programs 8 and 9

0x1B38	User calc output 10 and 11 TxPDOMap OV1			
	:001 0x7C09:001 User calc 10_OV00			
	:002			
	0x7C0A:001 User calc 11_OV00			
0x1B39	User calc output 10 and 11 TxPDOMap OV2			
	:001 0x7C09:001 User calc 10_OV00	:002 0x7C09:002 User calc 10_OV01		
	:003 0x7C0A:001 User calc 11_OV00	:004 0x7C0A:002 User calc 11_OV01		
0x1B3A	User calc output 10 and 11 TxPDOMap OV4			
	:001 0x7C09:001 User calc 10_OV00	:002 0x7C09:002 User calc 10_OV01	:003 0x7C09:003 User calc 10_OV02	:004 0x7C09:004 User calc 10_OV03
	:005 0x7C0A:001 User calc 11_OV00	:006 0x7C0A:002 User calc 11_OV01	:007 0x7C0A:003 User calc 11_OV02	:008 0x7C0A:004 User calc 11_OV03
0x1B3B	User calc output 10 and 11 TxPDOMap OV8			
	:001 0x7C09:001 User calc 10_OV00	:002 0x7C09:002 User calc 10_OV01	:003 0x7C09:003 User calc 10_OV02	:004 0x7C09:004 User calc 10_OV03
	:005 0x7C09:005 User calc 10_OV004	:006 0x7C09:006 User calc 10_OV05	:007 0x7C09:007 User calc 10_OV06	:008 0x7C09:008 User calc 10_OV07
	:009 0x7C0A:001 User calc 11_OV00	:010 0x7C0A:002 User calc 11_OV01	:011 0x7C0A:003 User calc 11_OV02	:012 0x7C0A:004 User calc 11_OV03
	:013 0x7C0A:005 User calc 11_OV04	:014 0x7C0A:006 User calc 11_OV05	:015 0x7C0A:007 User calc 11_OV06	:016 0x7C0A:008 User calc 11_OV07

Fig. 120 Mapping for calculation programs 10 and 11

0x1B40	User calc output 12 and 13 TxPDOMap OV1			
	:001 0x7C0B:001 User calc 12_OV00			
	:002			
	0x7C0C:001 User calc 13_OV00			
0x1B41	User calc output 12 and 13 TxPDOMap OV2			
	:001 0x7C0B:001 User calc 12_OV00	:002 0x7C0B:002 User calc 12_OV01		
	:003 0x7C0C:001 User calc 13_OV00	:004 0x7C0C:002 User calc 13_OV01		
0x1B42	User calc output 12 and 13 TxPDOMap OV4			
	:001 0x7C0B:001 User calc 12_OV00	:002 0x7C0B:002 User calc 12_OV01	:003 0x7C0B:003 User calc 12_OV02	:004 0x7C0B:004 User calc 12_OV03
	:005 0x7C0C:001 User calc 13_OV00	:006 0x7C0C:002 User calc 13_OV01	:007 0x7C0C:003 User calc 13_OV02	:008 0x7C0C:004 User calc 13_OV03
0x1B43	User calc output 12 and 13 TxPDOMap OV8			
	:001 0x7C0B:001 User calc 12_OV00	:002 0x7C0B:002 User calc 12_OV01	:003 0x7C0B:003 User calc 12_OV02	:004 0x7C0B:004 User calc 12_OV03
	:005 0x7C0B:005 User calc 12_OV004	:006 0x7C0B:006 User calc 12_OV05	:007 0x7C0B:007 User calc 12_OV06	:008 0x7C0B:008 User calc 12_OV07
	:009 0x7C0C:001 User calc 13_OV00	:010 0x7C0C:002 User calc 13_OV01	:011 0x7C0C:003 User calc 13_OV02	:012 0x7C0C:004 User calc 13_OV03
	:013 0x7C0C:005 User calc 13_OV04	:014 0x7C0C:006 User calc 13_OV05	:015 0x7C0C:007 User calc 13_OV06	:016 0x7C0C:008 User calc 13_OV07

Fig. 121 Mapping for calculation programs 12 and 13

0x1B48	User calc output 14 and 15 TxPDOMap OV1			
	:001 0x7C0D:001 User calc 14_OV00			
	:002			
	0x7C0E:001 User calc 15_OV00			
0x1B49	User calc output 14 and 15 TxPDOMap OV2			
	:001 0x7C0D:001 User calc 14_OV00	:002 0x7C0D:002 User calc 14_OV01		
	:003 0x7C0E:001 User calc 15_OV00	:004 0x7C0E:002 User calc 15_OV01		
0x1B4A	User calc output 14 and 15 TxPDOMap OV4			
	:001 0x7C0D:001 User calc 14_OV00	:002 0x7C0D:002 User calc 14_OV01	:003 0x7C0D:003 User calc 14_OV02	:004 0x7C0D:004 User calc 14_OV03
	:005 0x7C0E:001 User calc 15_OV00	:006 0x7C0E:002 User calc 15_OV01	:007 0x7C0E:003 User calc 15_OV02	:008 0x7C0E:004 User calc 15_OV03
0x1B4B	User calc output 14 and 15 TxPDOMap OV8			
	:001 0x7C0D:001 User calc 14_OV00	:002 0x7C0D:002 User calc 14_OV01	:003 0x7C0D:003 User calc 14_OV02	:004 0x7C0D:004 User calc 14_OV03
	:005 0x7C0D:005 User calc 14_OV004	:006 0x7C0D:006 User calc 14_OV05	:007 0x7C0D:007 User calc 14_OV06	:008 0x7C0D:008 User calc 14_OV07
	:009 0x7C0E:001 User calc 15_OV00	:010 0x7C0E:002 User calc 15_OV01	:011 0x7C0E:003 User calc 15_OV02	:012 0x7C0E:004 User calc 15_OV03
	:013 0x7C0E:005 User calc 15_OV04	:014 0x7C0E:006 User calc 15_OV05	:015 0x7C0E:007 User calc 15_OV06	:016 0x7C0E:008 User calc 15_OV07

Fig. 122 Mapping for calculation programs 14 and 15

0x1B50	User calc output 16 and 17 TxPDOMap OV1			
	:001 0x7C0F:001 User calc 16_OV00			
	:002			
	0x7C10:001 User calc 17_OV00			
0x1B51	User calc output 16 and 17 TxPDOMap OV2			
	:001 0x7C0F:001 User calc 16_OV00	:002 0x7C0F:002 User calc 16_OV01		
	:003 0x7C10:001 User calc 17_OV00	:004 0x7C10:002 User calc 17_OV01		
0x1B52	User calc output 16 and 17 TxPDOMap OV4			
	:001 0x7C0F:001 User calc 16_OV00	:002 0x7C0F:002 User calc 16_OV01	:003 0x7C0F:003 User calc 16_OV02	:004 0x7C0F:004 User calc 16_OV03
	:005 0x7C10:001 User calc 17_OV00	:006 0x7C10:002 User calc 17_OV01	:007 0x7C10:003 User calc 17_OV02	:008 0x7C10:004 User calc 17_OV03
0x1B53	User calc output 16 and 17 TxPDOMap OV8			
	:001 0x7C0F:001 User calc 16_OV00	:002 0x7C0F:002 User calc 16_OV01	:003 0x7C0F:003 User calc 16_OV02	:004 0x7C0F:004 User calc 16_OV03
	:005 0x7C0F:005 User calc 16_OV004	:006 0x7C0F:006 User calc 16_OV05	:007 0x7C0F:007 User calc 16_OV06	:008 0x7C0F:008 User calc 16_OV07
	:009 0x7C10:001 User calc 17_OV00	:010 0x7C10:002 User calc 17_OV01	:011 0x7C10:003 User calc 17_OV02	:012 0x7C10:004 User calc 17_OV03
	:013 0x7C10:005 User calc 17_OV04	:014 0x7C10:006 User calc 17_OV05	:015 0x7C10:007 User calc 17_OV06	:016 0x7C10:008 User calc 17_OV07

Fig. 123 Mapping for calculation programs 16 and 17

0x1B58	User calc output 18 and 19 TxPDOMap OV1			
	:001 0x7C11:001 User calc 18_OV00			
	:002			
	0x7C12:001 User calc 19_OV00			
0x1B59	User calc output 18 and 19 TxPDOMap OV2			
	:001 0x7C11:001 User calc 18_OV00	:002 0x7C11:002 User calc 18_OV01		
	:003 0x7C12:001 User calc 19_OV00	:004 0x7C12:002 User calc 19_OV01		
0x1B5A	User calc output 18 and 17 TxPDOMap OV4			
	:001 0x7C11:001 User calc 18_OV00	:002 0x7C11:002 User calc 18_OV01	:003 0x7C11:003 User calc 18_OV02	:004 0x7C11:004 User calc 16_OV03
	:005 0x7C12:001 User calc 19_OV00	:006 0x7C12:002 User calc 19_OV01	:007 0x7C12:003 User calc 19_OV02	:008 0x7C12:004 User calc 17_OV03
0x1B5B	User calc output 18 and 17 TxPDOMap OV8			
	:001 0x7C11F:001 User calc 18_OV00	:002 0x7C11:002 User calc 18_OV01	:003 0x7C11:003 User calc 18_OV02	:004 0x7C11:004 User calc 18_OV03
	:005 0x7C11:005 User calc 18_OV004	:006 0x7C11:006 User calc 18_OV05	:007 0x7C11:007 User calc 18_OV06	:008 0x7C11:008 User calc 18_OV07
	:009 0x7C12:001 User calc 19_OV00	:010 0x7C12:002 User calc 19_OV01	:011 0x7C12:003 User calc 19_OV02	:012 0x7C12:004 User calc 19_OV03
	:013 0x7C12:005 User calc 19_OV04	:014 0x7C12:006 User calc 19_OV05	:015 0x7C12:007 User calc 19_OV06	:016 0x7C12:008 User calc 19_OV07

Fig. 124 Mapping for calculation programs 18 and 19

8.3.1.9 Example of TxPDO Mapping

In object 0x1C13, it is selected which PDOs are to be transferred. The PDO mapping objects are selected. The selection process takes place before switching from PreOP to SafeOP mode.

Example 1: Startup procedure to output distance 1 from channel 1 (01DIST1):

- Distance 1 is expressed in 0x6000. In order to transfer 0x6000 in the PDO, the PDO mapping object 0x1A00 must be selected in 0x1C13.

Object	Value	Description
0x1C13:00	0x00	clear sm pdos (0x1C13)
0x1C13:01	0x1A00	download pdo 0x1C13:01 index
0x1C13:00	0x01	download pdo 0x1C13 count

Example 2: Startup procedure to output distance 1, the exposure time and the encoders.

- Distance 1 is expressed in 0x6000. In order to transfer 0x6000 in the PDO, the PDO mapping object 0x1A00 must be selected in 0x1C13.
- The shutter speed is expressed in 0x6030. In order to transfer 0x6030 in the PDO, PDO mapping object 0x1A80 must be selected in 0x1C13.
- Encoder 1 is output in 0x6050, encoder 2 in 0x6051 and encoder 3 in 0x6052. The process data is summarized in 0x1AC0, for transfer in the PDO, it must be selected in 0x1C13.

Object	Value	Description
0x1C13:00	0x00	clear sm pdos (0x1C13)
0x1C13:01	0x1A00	download pdo 0x1C13:01 index
0x1C13:02	0x1A80	download pdo 0x1C13:02 index
0x1C13:03	0x1AC0	download pdo 0x1C13:03 index
0x1C13:00	0x03 (3)	download pdo 0x1C13 count

8.3.1.10 Object 1C00h: Synchronous Manager Type

1C00	RECORD	Sync manager type			ro
------	--------	-------------------	--	--	----

Subindices

0	VAR	Number of entries	4	Unsigned8	ro
1	VAR	Sync manager 1	0x01	Unsigned8	ro
2	VAR	Sync manager 2	0x02	Unsigned8	ro
3	VAR	Sync manager 3	0x03	Unsigned8	ro
4	VAR	Sync manager 4	0x04	Unsigned8	ro

8.3.1.11 Object 1C12h: RxPDO Assign

1C12	ARRAY	RxPDO assign			rw
------	-------	--------------	--	--	----

Subindices

0	VAR	Number of entries	0	Unsigned8	ro
---	-----	-------------------	---	-----------	----

No RxPDOs can be selected because none are present. The object is implemented as a dummy to enable the EtherCAT master to set the RxPDOs to 0.

8.3.1.12 Object 1C13h: TxPDO Assign

1C13	ARRAY	TxPDO assign			rw
------	-------	--------------	--	--	----

Subindices

0	VAR	Number of entries	n	Unsigned8	rw
1	VAR	Subindex 001	0x1A00	Unsigned16	rw
2	VAR	Subindex 002		Unsigned16	rw
..					
n	VAR	Subindex n	-	Unsigned16	rw

Object for selecting the PDOs (TxPDO maps), see [Chap. 8.3.1.7](#).

8.3.1.13 Object 1C32h: Sync Manager Output Parameters

See description Input Parameters, see [Chap. 8.3.1.14](#).

8.3.1.14 Object 1C33h: Sync Manager Input Parameters

1C33	RECORD	SM input parameter			
Subindices					
0	VAR	Number of entries	9	Unsigned8	ro
1	VAR	Synchronization type	x	Unsigned16	ro
2	VAR	Cycle time	x	Unsigned32	ro
4	VAR	Synchronization types supported	0x4007	Unsigned16	ro
5	VAR	Minimum cycle time	1250000	Unsigned32	ro
6	VAR	Calc and copy time	x	Unsigned32	ro
8	VAR	Get cycle time	x	Unsigned16	rw
9	VAR	Delay time	x	Unsigned32	ro
0C	VAR	Cycle time too small counter	x	Unsigned16	ro
20	VAR	Sync error	x	BOOL	ro

- Synchronization type: synchronization currently selected, [see Fig. 125](#)
 - Cycle time: cycle time currently set in ns
 - Freerun: cycle time derived from the measuring rate,
 - SM2, SM3: cycle time derived from the measuring rate,
 - Sync0 synchronization, the Sync0 cycle time set by the master.
 - Synchronization types supported: The following are supported:
 - Freerun, SM2 / SM3 and Sync0 synchronization
 - Minimum cycle time: The minimum cycle time is derived from the maximum measuring rate and is 125 μ s for IFD2410 or IFD2411 and 40 μ s for IFD2415.
 - Calc and Copy Time: The Calc and Copy time is the time after the input latch (input data are available in the slave) until the input data is copied into the Sync-Manager-3 area (transfer of the data to Industrial Ethernet). The Calc and Copy Time from 0x1C33 is only calculated if the Distributed Clocks are enabled. The value is recalculated each time it is read. Since the sensor does not have output data, the Calc and copy time of 0x1C32 always returns to 0.
 - Delay time: The delay time is the hardware-related delay until the input latch is reached.
- The delay time from 0x1C33 is only calculated if the Distributed Clocks are activated. The value is recalculated each time it is read. Since the sensor does not have output data, the Delay time from 0x1C32 always returns to 0.
- Cycle Time Too Small Counter: This counter is incremented if the cycle time is too low, so that the input data could not be provided for the next SM event.
 - Sync Error
 - 0: No errors.
 - 1: A synchronization occurred. The Cycle Time Too Small Counter has been incremented.

The set synchronization depends on the combination of 0x1C33:001 and 0x1C32:001. The synchronization changes during a transition from the PreOP state to the SafeOP state. If the combination is invalid, an error message is displayed when the state is changed. Process data communication will then not be possible.

0x1C32 Synchronization Type	0x1C33 Synchronization Type	Synchronization
0x00	0x00	Free Run
0x01	0x22	SM2
0xyy	0x01	SM3
0x02	0x02	Sync0

Fig. 125 Example of synchronization

An activation of the Distributed Clocks does not automatically change the Sync0 mode. The synchronization can only be changed by writing the objects 0x1C32 and 0x1C33.

8.3.2 Manufacturer Specific Objects

8.3.2.1 Overview

Index (h)	Name	IFD2410	IFD2411	IFD2415	Description
3001	User level	•	•	•	Login, logout, change password
3005	Controller information	•	•	•	Information on the IFD241x (further)
3011	Correction ch 1	•	•	•	Dark correction
3020	Basic settings	•	•	•	Load, save, factory setting
3021	Preset settings	•	•	•	
3022	Measurement settings	•	•	•	Measurement settings
303F	Sensor error	•	•	•	Error IFD241x Channel 1
3101	Reset	•	•	•	Restart IFD241x
3105	Factory reset	•	•	•	Factory settings
3107	Counter reset	•	•	•	Reset counter
3133	LED on/off ch 1	•	•	•	LED light source channel 1
3150	Sensor ch 1	•	•	•	Error IFD241x channel 1
3152	Select sensor		•		Sensor selection
3153	Sensor table		•		Sensor table
3156	Multilayer options ch 1	•	•	•	
3161	Peak position ch 1	•	•	•	Peak selection channel 1
3162	Peak options ch 1	•	•	•	Peak options channel 1
31B0	Digital interfaces	•	•	•	Digital Interfaces
31B1	Enable output	•	•	•	Interface selection
31B2	Outhold	•	•	•	Error handling
31B3	Outreduce settings	•	•	•	Data reduction
31D0	Analog output	•	•	•	Analog output, scaling
31F3	Switching output 1	•		•	Switching output 1/2
31F4	Switching output 2	•		•	
31F5	RS422 output	•	•	•	Data output with RS422
3250	Shutter mode ch 1	•	•	•	Exposure mode channel 1
3251	Measuring rate	•	•	•	Measuring Rate
34A0	Keylock	•	•	•	Lock key on IFD241x
35A0	Encoder	•	•	•	Encoder settings
35B0	Trigger settings	•	•	•	Triggering settings
35B1	Synchronization	•	•	•	Synchronization, terminating resistor
3711	Range of interest ch 1	•	•	•	Range of interest masking
3800	Material info and edit	•	•	•	Material information
3802	Material table edit	•	•	•	Edit material table
3803	Material table	•	•	•	Materials present in the material table
3804	Material selection ch 1	•	•	•	Select material
Index (h)	Name	IFD2410	IFD2411	IFD2415	Description
39FF-3A09	Mastering y	•	•	•	Master value, mastering
3A10-3A12	Statistic y	•	•	•	Statistics
3C00-3C09	Comp y ch 1	•	•	•	Measured value calculation Channel 1
3CBF	Sys signals	•	•	•	
3E00	User calc	•	•	•	

Invalid entries when reading and writing manufacturer-specific objects can result in errors. These errors are described in the SDO abort codes, see [Chap. 8.5](#). If an error occurs while writing a value, you may be able to retrieve error details in object 303F.

8.3.2.2 Object 3001h: User Level

3001	RECORD	User level			
Subindices					
0	VAR	Number of entries	7	Unsigned8	ro
1	VAR	Actual user	x	Unsigned8	ro
2	VAR	Login		Visible string	wo
3	VAR	Logout	FALSE	BOOL	rw
4	VAR	User level when restarting	x	Unsigned8	rw
5	VAR	Password old		Visible string	wo
6	VAR	Password new		Visible string	wo
7	VAR	Password repeat		Visible string	wo

For more information, please refer to the Login section, see [Chap. 6.6.4](#).

Actual user, standard user:

0 - Operator

1 - Professional

Modifying the user level will also change the access rights for objects. On the user level, once you log out, all RW objects change to read-only (= ro), and write-only objects (= wo) will no longer be available.

To change the password, you need to complete the three passwords fields (Old, New and Repeat) in this particular order. The maximum password length is 31 characters.

8.3.2.3 Object 3005h: Information on the IFD241x (further)

3005	RECORD	Controller info			ro
Subindices					
0	VAR	Number of entries	8	Unsigned8	ro
1	VAR	Name	IFC24xx,	Visible String	ro
5	VAR	Serial no.	xxxxxxx	Visible String	ro
6	VAR	Option No	xxx	Visible String	ro
8	VAR	Article No.	xxxxxxx	Visible String	ro

For more information, please refer to the Controller Information section, see [Chap. A 5.3.1.2](#).

8.3.2.4 Object 3011h: Correction, Channel 1

3011	RECORD	Correction channel 1			ro
Subindices					
0	VAR	Number of entries	3	Unsigned8	ro
1	VAR	Dark correction start	FALSE	BOOL	wo
3	VAR	Dark correction state	x	Unsigned32	ro

Writing 1 (True) to subindex 1 triggers a dark correction. Subindex 3 shows the state of the correction; the possible values are:

- 0: no correction active
- 1: Correction active
- 100: Error during the correction process

Once correction has been initiated, the status changes from 0 to 1. If no error occurs, the status changes back to 0 when correction is completed. No settings may be changed while a correction is active.

For more information, please refer to the Dark Correction section, see [Chap. A 5.3.4.3](#).

8.3.2.5 Object 3020h: Load, Save, Factory Setting

3020	RECORD	Basic settings			ro
------	--------	----------------	--	--	----

Subindices

0	VAR	Number of entries	3	Unsigned8	ro
1	VAR	READ		BOOL	wo
2	VAR	STORE		BOOL	wo
3	VAR	SETDEFAULT		BOOL	wo

- READ: Loading the last basic settings saved
- STORE: Saves the current settings
- SETDEFAULT: Resets the basic settings to factory settings

8.3.2.6 Object 3021h: Preset

3021	RECORD	Preset			ro
------	--------	--------	--	--	----

Subindices

0	VAR	Number of entries	3	Unsigned8	ro
1	VAR	Mode	x	Unsigned8	rw
2	VAR	List		Visual string	ro
3	VAR	Named read		Visual string	wo

Mode:

- 0 – STATIC
- 1 – BALANCED
- 2 – DYNAMIC

For more information, please refer to the Measurement Settings section, see [Chap. 8.3.2.7](#).

8.3.2.7 Object 3022h: Measurement Settings

3022	RECORD	Measurement settings			ro
------	--------	----------------------	--	--	----

Subindices

0	VAR	Number of entries	7	Unsigned8	
1	VAR	Current		Visual string	ro
2	VAR	Named read		Visual string	wo
3	VAR	Named store		Visual string	wo
4	VAR	Named delete		Visual string	wo
5	VAR	Initial meassettings		Visual string	rw
6	VAR	List		Visual string	ro
7	VAR	Set default		BOOL	wo

- Current: Current measurement settings (MEASSETTINGS CURRENT)
- Named read: Loads a measurement setting from the `list` / sub-index 6 (MEASSETTINGS READ)
- Named store: Saves the current measurement setting. You can assign a name or number (MEASSETTINGS STORE)
- Named delete: Deletes a measurement setting from the `list`/sub-index 6 (MEASSETTINGS DELETE)
- Initial meassettings: Measurement setting that is initially loaded when the IFD241x is reset (MEASSETTINGS INITIAL)
- List: List of saved measurement settings (MEASSETTINGS LIST)
- Set default: Corresponds to the SETDEFAULT MEASSETTINGS command

For more information, please refer to the Measurement Settings section, see [Chap. A 5.3.8.6](#).

8.3.2.8 Object 303Fh: Error IFD241x

303F	RECORD	Sensor error			ro
Subindices					
0	VAR	Number of entries	2	Unsigned8	ro
1	VAR	Error number	x	Unsigned16	ro
2	VAR	Error description	x	Visible String	ro

For more information, please refer to the Error Messages section.

- Sensor error number: Outputs the error during communication
- Sensor error description: Error as plain text

8.3.2.9 Object 3101h: Reset

3101	VAR	Reset	FALSE	BOOL	rw
------	-----	-------	-------	------	----

The IFD241x is restarted.

8.3.2.10 Object 3105h: Factory Settings

3105	VAR	Factory reset		BOOL	wo
------	-----	---------------	--	------	----

Complete reset to factory settings. Corresponds to the SETDEFAULT ALL command.

8.3.2.11 Object 3107h: Reset Counter

3107	RECORD	Counter reset			ro
Subindices					
0	VAR	Number of entries	2	Unsigned8	ro
1	VAR	Reset timestamp		BOOL	wo
2	VAR	Reset counter		BOOL	wo

Setting sub-index 1 to 1 will reset the timestamp (0x7001). Setting sub-index 2 to 1 will reset the measured value counter (0x7000).

8.3.2.12 Object 3133h: LED Light Source Channel 1

3133	RECORD	LED on/off ch1			ro
Subindices					
0	VAR	Number of entries	2	Unsigned8	ro
1	VAR	LED on/off	x	BOOL	rw
2	VAR	LED source	x	Unsigned8	rw

LED on/off:

- 0 – Off
- 1 – On

Permits switching the LED light source on or off and is equivalent to the LED command.

8.3.2.13 Object 3150h: Error IFD241x Channel 1

3150	RECORD	Sensor ch1			ro
Subindices					
0	VAR	Number of entries	3	Unsigned8	ro
1	VAR	Sensor info	IFS24xx-xx	Visible String	ro
2	VAR	Sensor range	xx.xxxxxx	FLOAT32	ro
3	VAR	Sensor serial no.	xxxxxxx	Visible String	ro

For more information, please refer to the Sensor section, see [Chap. A 5.3.4](#).

8.3.2.14 Object 3152h: Sensor Selection Channel 1

Object is valid for the IFD2411.

3152	RECORD	Select sensor ch1			ro
Subindices					
0	VAR	Number of entries	4	Unsigned8	ro
1	VAR	Select sensor		Unsigned8	rw
2	VAR	Sensor name	IFS24xx-xx	Visible String	ro
3	VAR	Measurement range	xx.xxxxxx	FLOAT32	ro
4	VAR	Sensor serial no.	xxxxxxx	Visible String	ro

For more information, please refer to the Select Sensor section, see [Chap. A 5.3.4](#).

8.3.2.15 Object 3153h: Sensor Table

Object is valid for the IFD2411.

3153	RECORD	Select table ch1			ro
Subindices					
0	VAR	Number of entries	6	Unsigned8	ro
1	VAR	Position		Unsigned8	rw
2	VAR	Get next position		BOOL	ro
3	VAR	Get previous position		BOOL	ro
4	VAR	Sensor name	IFS24xx-xx	Visible String	ro
5	VAR	Measurement range	xx.xxxxxx	FLOAT32	ro
6	VAR	Sensor serial no.	xxxxxxx	Visible String	ro

8.3.2.16 Object 3156h: Multilayer Options for Channel 1

3156	RECORD	Multilayer options ch1			ro
Subinzes					
0	VAR	Number of entries	2	Unsigned8	ro
1	VAR	Peak count		Unsigned32	rw
2	VAR	Disable refractivity correction	FALSE	BOOL	rw

Includes the options for thickness and multilayer measurements.

Sub-index 1 corresponds to the PEAKCOUNT command.

Sub-index 2 corresponds to the REFRACCORR command.

Disable refractivity correction: Disables the refractivity correction

8.3.2.17 Object 3161h: Peak Selection Channel 1

3161	VAR	Peak position	0	Unsigned8	rw
------	-----	---------------	---	-----------	----

The peak(s) that are evaluated in the distance/thickness measurement mode can be set using this command.

Standard: first peak / first and second peak

In order to receive transparent measuring results, the standard setting should only be changed where absolutely required.

0	first and last peak
1	second-last and last peak
2	first and second peak
3	highest and second highest peak

8.3.2.18 Object 3162h: Peak Options Channel 1

3162	RECORD	Peak options ch1			ro
Subindices					
0	VAR	Number of entries	2	Unsigned8	ro
1	VAR	Min threshold		FLOAT32	rw
2	VAR	Peak modulation		FLOAT32	rw

Min threshold: Peak detection threshold, corresponds to the MIN_THRESHOLD command.

8.3.2.19 Object 31B0h: Digital Interfaces

31B0	RECORD	Digital interfaces			ro
Subindices					
0	VAR	Number of entries	2	Unsigned8	ro
2	VAR	RS422 baud rate	x	Unsigned32	rw

Subindex 2 is equivalent to the BAUDRATE command. Only the preset baud rates can be specified:

RS422 baud rate: 9600, 115200, 230400, 460800, 691200, 921600, 1500000, 2000000, 3500000, 4000000

8.3.2.20 Object 31B1h: Interface Selection

31B1	RECORD	Enable output			ro
Subindices					
0	VAR	Number of entries	5	Unsigned8	ro
1	VAR	RS422	x	BOOL	rw
3	VAR	Analog out		BOOL	rw
4	VAR	Switching outputs		BOOL	rw
5	VAR	Industrial Ethernet		BOOL	rw

Corresponds to the OUTPUT command. Parallel output of measured values via the respective interface can be switched on and off.

8.3.2.21 Object 31B2h: Error Handling

31B2	RECORD	Outhold			ro
Subindices					
0	VAR	Number of entries	2	Unsigned8	ro
1	VAR	Error handling type		Unsigned8	rw
2	VAR	Error handling values		Unsigned32	rw

8.3.2.22 Object 31B3h: Data Reduction

31B3	RECORD	Outreduce settings			ro
Subindices					
0	VAR	Number of entries	3	Unsigned8	ro
2	VAR	Reduction analog		BOOL	rw
3	VAR	Reduction RS422		BOOL	rw
4	VAR	Reduction factor		Unsigned32	rw

8.3.2.23 Object 31D0h: Analog Output

31D0	RECORD	Analog output			ro
Subindices					
0	VAR	Number of entries	55	Unsigned8	ro
1	VAR	Analog output	x	Unsigned8	rw
2	VAR	Analog signal	x	Visible string	rw
4	VAR	Type of scaling	x	Unsigned8	rw
5	VAR	Two-point-scaling start	x.x	FLOAT32	rw
6	VAR	Two-point-scaling end	x.x	FLOAT32	rw
50	VAR	Available signals part 0		Visible string	ro
51	VAR	Available signals part 1		Visible string	ro
52	VAR	Available signals part 2		Visible string	ro
53	VAR	Available signals part 3		Visible string	ro
54	VAR	Available signals part 4		Visible string	ro
55	VAR	Available signals part 5		Visible string	ro

For more information, please refer to the Analog Output section, see [Chap. A 5.3.15](#).

Analog output:

- 0 - Voltage 0 ... 5 V
- 1 - Voltage 0 ... 10 V
- 7 - Current 4 ... 20 mA

Signal: Data can only be selected in accordance with the selected measuring program – for distance measurements, only distance 1 can be selected.

You can, for example, select 01DIST1. `Available signals` lists the available signals.

Type of scaling:

- 0 - Standard scaling
- 1 - Two-point scaling

8.3.2.24 Object 31F3h: Switching Output 1

Object is valid for IFD2410/2415.

31F3	RECORD	Switching output			ro
Subindices					
0	VAR	Number of entries	55	Unsigned8	ro
1	VAR	Output level		Unsigned8	rw
2	VAR	Error out		Unsigned8	rw
3	VAR	Limit signal		Visible string	rw
5	VAR	Lower limit value		FLOAT32	rw
6	VAR	Upper limit value		FLOAT32	rw
7	VAR	Compare to		Unsigned8	rw
8	VAR	Error hysteresis		FLOAT32	rw
50	VAR	Available signals part 0		Visible string	ro
51	VAR	Available signals part 1		Visible string	ro
52	VAR	Available signals part 2		Visible string	ro
53	VAR	Available signals part 3		Visible string	ro
54	VAR	Available signals part 4		Visible string	ro
55	VAR	Available signals part 5		Visible string	ro

For more information, please refer to the Switching Output section, see [Chap. A 5.3.14](#).

Output level:

- 0 - PNP
- 1 - NPN
- 2 - Push-pull
- 3 - Push-pull, negated

Error out:

- 1 - 01ER1
- 2 - 01ER2
- 3 - 01ER12
- 4 - 02ER1
- 5 - 02ER2
- 6 - 02ER12
- 7 - 0102ER12
- 8 - ERRORLIMIT

Use `Limit signal` to select a measured value signal that will be used for the comparison.

`Available signals` contains a list of the available signals.

Compare to:

- 1 - Lower
- 2 - Upper
- 3 - Both

Object 31F4h includes the settings for switching output 2.

8.3.2.25 Object 31F5h: RS422 Output

31F5	RECORD	RS422 output			ro
Subindices					
0	VAR	Number of entries	93	Unsigned8	ro
1	VAR	RS422 add output signal		Unsigned8	rw
2	VAR	RS422 remove output signal		Unsigned8	rw
3	VAR	RS422 reset output signals		Visible string	rw
50	VAR	RS422 available signals part 0		FLOAT32	ro
51	VAR	RS422 available signals part 1		FLOAT32	ro
...					
63	VAR	RS422 available signals part 12		FLOAT32	
81	VAR	Outputinfo RS422 part 0		Visible string	ro
82	VAR	Outputinfo RS422 part 1		Visible string	ro
...					
93	VAR	Outputinfo RS422 part 12		Visible string	ro

8.3.2.26 Object 3250h: Exposure Mode Channel 1

3250	RECORD	Shutter mode ch1			
Subindices					
0	VAR	Number of entries	4	Unsigned8	ro
1	VAR	Shutter mode	x	Unsigned8	rw
3	VAR	Shutter time 1	x.xx	FLOAT32	rw
4	VAR	Shutter time 2	x.xx	FLOAT32	rw

For more information, please refer to the Exposure Mode, see [Chap. 6.2.5](#), Exposure Mode, see [Chap. A 5.3.9.4](#), and Exposure Time, see [Chap. A 5.3.9.6](#).

Shutter mode:

- 1 - Measurement mode
- 2 - Manual mode
- 3 - Two-time mode alternating
- 4 - Two-time mode automatic

Object 3250h includes the exposure settings for channel 2.

8.3.2.27 Object 3251h: Measuring Rate

3251	RECORD	Measuring rate		FLOAT32	rw
------	--------	----------------	--	---------	----

For more information, please refer to the Measuring Rate section, see [Chap. A 5.3.9.5](#).

8.3.2.28 Object 34A0h: Keylock

34A0	RECORD	Keylock			ro
Subindices					
0	VAR	Number of entries	2	Unsigned8	ro
1	VAR	Mode	0	Unsigned8	rw
2	VAR	Key lock countdown [min]	0	Unsigned8	rw

Mode:

- 0 - Inactive
- 1 - Active
- 2 - Automatic mode / Active after delay

8.3.2.29 Object 35A0h: Encoder

Encoder 2/3 is possible with IFD2410/2415.

35A0	RECORD	RS422 output			ro
Subindices					
0	VAR	Number of entries	17	Unsigned8	ro
1	VAR	Encoder 1 reference signal		Unsigned8	rw
2	VAR	Encoder 1 interpolation		Unsigned8	rw
3	VAR	Encoder 1 initial value		Unsigned32	rw
4	VAR	Encoder 1 maximum value		Unsigned32	rw
5	VAR	Encoder 1 set value		BOOL	wo
6	VAR	Encoder 2 reference signal		Unsigned8	rw
7	VAR	Encoder 2 interpolation		Unsigned8	rw
8	VAR	Encoder 2 initial value		Unsigned32	rw
9	VAR	Encoder 2 maximum value		Unsigned32	rw
10	VAR	Encoder 2 set value		BOOL	wo
11	VAR	Encoder 3 reference signal		Unsigned8	rw
12	VAR	Encoder 3 interpolation		Unsigned8	rw
13	VAR	Encoder 3 initial value		Unsigned32	rw
14	VAR	Encoder 3 maximum value		Unsigned32	rw
15	VAR	Encoder 3 set value		BOOL	wo
16	VAR	Set encoder		Unsigned8	wo
17	VAR	Reset encoder		Unsigned8	wo

For more information, please refer to the Encoder Inputs, see [Chap. 6.1.2](#) and Encoder section see [Chap. A 5.3.6](#).

Encoder reference signal:

- 0 - None, the encoder's reference marker has no effect
- 1 - One, specified once
- 3 - Ever, set for all markers

Encoder interpolation:

- 1 - Single interpolation
- 2 - Dual interpolation
- 3 - Quadruple interpolation

Encoder initial value:

0 ... $2^{32}-1$

Encoder maximal value:

0 ... $2^{32}-1$

8.3.2.30 Object 35B0 Triggering

35B0	RECORD	Trigger			ro
Subindices					
0	VAR	Number of entries	11	Unsigned8	ro
1	VAR	Trigger at		Unsigned8	rw
2	VAR	Trigger source		Unsigned8	rw
3	VAR	Trigger mode		Unsigned8	rw
4	VAR	Trigger level		Unsigned8	rw
5	VAR	Trigger count type		Unsigned8	rw
6	VAR	Trigger count value		Unsigned16	rw
7	VAR	Trigger software		BOOL	ro
8	VAR	Trigger encoder minimum		Unsigned32	rw
9	VAR	Trigger encoder maximum		Unsigned32	rw
10	VAR	Trigger encoder step size		Unsigned32	rw
11	VAR	MFI level		Unsigned8	rw

8.3.2.31 Object 35B1 Synchronization

35B1	RECORD	Synchronization			ro
Subindices					
0	VAR	Number of entries	2	Unsigned8	ro
1	VAR	Sync mode		Unsigned8	rw
2	VAR	Termination		BOOL	rw

8.3.2.32 Object 3711h: Range of Interest Masking Channel 1

3711	RECORD	Range of interest ch1			
Subindices					
0	VAR	Number of entries	12	Unsigned8	ro
11	VAR	Range of interest start	x	Unsigned16	rw
12	VAR	Range of interest end	x	Unsigned16	rw

For more information, please refer to the section Range of Interest Masking, see [Chap. 6.2.4](#), see [Chap. A 5.3.9.7](#).

8.3.2.33 Object 3800h: Material Information

3800	RECORD	Material info and edit			
Subindices					
0	VAR	Number of entries	7	Unsigned8	ro
1	VAR	Name	xxxxx	Visible string	rw
2	VAR	Description	xxxxxx	Visible string	rw
3	VAR	Type of refraction	xx	Unsigned8	rw
4	VAR	nd value	x.xxxx	FLOAT32	rw
5	VAR	nF value	x.xxxx	FLOAT32	rw
6	VAR	nC value	x.xxxx	FLOAT32	rw
7	VAR	Abbe number	x.xxxx	FLOAT32	rw

For more information, please refer to the Material Database section, see [Chap. 6.2.8](#), see [Chap. A 5.3.10](#).

Material name: Currently selected material for a thickness measurement

Material description: Description of the currently selected material

nd, nf and nC: Refractivity index of the currently selected material at 587 nm, 486 nm and 656 nm

Abbe number: Abbe number for the currently selected material

In Professional mode, the current material can also be edited here. Specified settings are saved immediately.

8.3.2.34 Object 3802h: Edit Material Table

3802	RECORD	Material table edit			
------	--------	---------------------	--	--	--

Subindices

0	VAR	Number of entries	4	Unsigned8	ro
1	VAR	Material delete	x	Visible string	wo
2	VAR	Reset materials	x	BOOL	wo
3	VAR	New material	x	BOOL	wo
4	VAR	Select material for edit		Visible string	rw

Material delete: Specify the name of a material to be deleted from the material table

Reset materials: Resets the material table to the factory settings

New material: Creates a new material in the material table. The newly created material (“NewMaterial”) is edited in object 3800h “Material info”.

Sub-index 4 selects the material that is to be edited in object 0x3800.

8.3.2.35 Object 3803h: Existing Materials

3803	RECORD	Material table			
------	--------	----------------	--	--	--

Subindices

0	VAR	Number of entries	5	Unsigned8	ro
1	VAR	Existing materials part 0		Visible string	ro
2	VAR	Existing materials part 1		Visible string	ro
3	VAR	Existing materials part 2		Visible string	ro
4	VAR	Existing materials part 3		Visible string	ro
5	VAR	Existing materials part 4		Visible string	ro

Provides a list of all available materials.

8.3.2.36 Object 3804h: Select Material for Channel 1

3804	RECORD	Material selection ch1			
------	--------	------------------------	--	--	--

Subindices

0	VAR	Number of entries	1	Unsigned8	ro
1	VAR	Material 1	xx	Visible string	rw

8.3.2.37 Object 3A00h: Mastering, Zeroing

3A00	RECORD	Master 1			
------	--------	----------	--	--	--

Subindices

0	VAR	Number of entries	55	Unsigned8	ro
1	VAR	Enable	xx	BOOL	rw
2	VAR	Signal	xx	Visible string	rw
4	VAR	Set/reset	xx	BOOL	rw
5	VAR	Value	xx	FLOAT32	rw
50	VAR	Available signals part 0		Visible string	ro
51	VAR	Available signals part 1		Visible string	ro
52	VAR	Available signals part 2		Visible string	ro
53	VAR	Available signals part 3		Visible string	ro
54	VAR	Available signals part 4		Visible string	ro
55	VAR	Available signals part 5		Visible string	ro

Masters a signal or sets it to zero; there are ten such objects (3A00h to 3A09). Sub-index 2 specifies which signal is to be mastered. Sub-index 4 corresponds to the MASTER command.

8.3.2.38 Object 3A10h: Statistics

3A10	RECORD	Statistic 1			
Subindices					
0	VAR	Number of entries	55	Unsigned8	ro
1	VAR	Enable		BOOL	rw
2	VAR	Signal		Visible string	rw
4	VAR	Infinite		BOOL	rw
5	VAR	Depth		Unsigned16	rw
6	VAR	Reset		BOOL	wo
50	VAR	Available signals part 0		Visible string	
51	VAR	Available signals part 1		Visible string	
52	VAR	Available signals part 2		Visible string	
53	VAR	Available signals part 3		Visible string	
54	VAR	Available signals part 4		Visible string	
55	VAR	Available signals part 5		Visible string	

Objects 3A10h to 3A12h generate three statistics signals.

Sub-index 50 ... 55 Corresponds to the command META_STATISTICSIGNAL.

Sub-index 6 corresponds to the STATISTIC command.

3 signals are generated for each statistics object activated. They are listed in object 0x3E00. The statistics function can also be applied to user signals.

Example: You want distance 1 (channel 1) to output the minimum and the maximum measured values using all previous distance values.

Activating a statistics object

3A10:01(Enable) to TRUE. Distance 1 (01DIST1) is selected as signal by default. If you would like to display statistics for a different signal, you will need to select the required signal in sub-index 2.

- Settings for all previous distance values
3A10:04 (Infinite) to True (STATISTICSIGNAL – INFINITE)

Assigning a user-defined signal to the PDO

The newly generated signal names appear in object 0x3E00h:

3E00:0	User calc	RO	> 60 <		
3E00:01	User calc 01	RO	01DIST1_MIN	7C00:0	UserCalcOutput01 RO > 1 <
3E00:02	User calc 02	RO	01DIST1_PEAK	7C01:0	UserCalcOutput02 RO > 1 <
3E00:03	User calc 03	RO	01DIST1_MAX	7C02:0	UserCalcOutput03 RO > 1 <
3E00:04	User calc 04	RO		7C03:0	UserCalcOutput04 RO > 1 <
3E00:05	User calc 05	RO		7C04:0	UserCalcOutput05 RO > 1 <
3E00:06	User calc 06	RO		7C05:0	UserCalcOutput06 RO > 1 <
3E00:07	User calc 07	RO		7C06:0	UserCalcOutput07 RO > 1 <
3E00:08	User calc 08	RO		7C07:0	UserCalcOutput08 RO > 1 <
3E00:09	User calc 09	RO			

The minimum distance is output in 0x7C00h and the maximum distance is output in 0x7C02h.

Select PDO

UserCalcOutput01 – 0x7C00h is selected with object 1B00h, and 0x7C02h is output with object 1B10h

1B00	UserCalc01 TxPDOMap	
	UserCalcOutput01	0x7C00
1B08	UserCalc02 TxPDOMap	
	UserCalcOutput02	0x7C01
1B10	UserCalc03 TxPDOMap	
	UserCalcOutput03	0x7C02

Extract from TxPDO Mapping, see [Chap. 8.3.1.7](#)

Therefore, the following selections need to be made in 0x1C13h, 0x1B00h and 0x1B10h before PreOp is switched to SafeOp:

0x00 (0)1B00	clear sm pdos (0x1C13)
0x1B00 (6912)	download pdo 0x1C13:01 index
0x1B10 (6928)	download pdo 0x1C13:02 index
0x02 (2)	download pdo 0x1C13 count

8.3.2.39 Object 3C00h: Measured Value Calculation Channel 1

3C00	RECORD	Comp y ch1			
Subindices					
0	VAR	Number of entries	55	Unsigned8	ro
1	VAR	Type		Unsigned8	rw
2	VAR	Name1		Visible string	rw
4	VAR	Signal1		Visible string	rw
5	VAR	Signal2		Visible string	rw
13	VAR	Factor1		FLOAT32	rw
14	VAR	Factor2		FLOAT32	rw
17	VAR	Offset		FLOAT32	rw
18	VAR	Parameter		Unsigned32	rw
50	VAR	Available signals part 0		Visible string	ro
51	VAR	Available signals part 1		Visible string	ro
52	VAR	Available signals part 2		Visible string	ro
53	VAR	Available signals part 3		Visible string	ro
54	VAR	Available signals part 4		Visible string	ro
55	VAR	Available signals part 5		Visible string	ro

Objects 3C00h to 3C09 generate 10 calculation modules for channel 1.

Type:

- 1 - Moving average (MOVING)
- 2 - Recursive average (RECURSIVE)
- 3 - Median (MEDIAN)
- 4 - Calculating two signals (CALC)

As soon as the type is changed, default settings are loaded for the selected type. You can only select signals from the corresponding channel.

Depending on the type, all other object entries have different meanings:

- Moving average (MOVING):

4	Signal1	Signal to which the filter will be applied (default 01DIST1)
18	Param1	Averaging value (default: 2)

Value range for Param1: 2 | 4 | 8 | 16 | 32 | 64 | 128 | 256 | 512 | 1024 | 2048 | 4096

- Recursive average (RECURSIVE):

4	Signal1	Signal to which the filter will be applied (default 01DIST1)
18	Param1	Averaging value (default: 2)

Value range for Param1: 2 ... 32000

- Median (MEDIAN)

4	Signal1	Signal to which the filter will be applied (default 01DIST1)
18	Param1	Averaging value (default: 3)

Value range for Param1: 3 | 5 | 7 | 9

- Calculating two signals (CALC)

2	Name	Name of the generated signal
4	Signal1	(default chx: 01DIST1)
5	Signal2	(default chx: 01DIST2)
13	Factor1	(default chx/sys: -1.0)
14	Factor2	(default chx/sys: 1.0)
18	Offset	(default chx/sys: 0.0)

$(\langle \text{factor1} \rangle * \langle \text{signal1} \rangle) + (\langle \text{factor2} \rangle * \langle \text{signal2} \rangle) + \langle \text{offset} \rangle$

Value range for offset (mm): -2147.0 ... 2147.0

i The object index determines the processing sequence and corresponds to the ID parameter for the ASCII command.

Example: Signal 01DIST1 is to be filtered using a median filter and an average value filter; the sequence is median filter first, then average value filter.

0x2C00:

1	Type	3 (Median)
4	Signal1	01DIST1
18	Param1	<Averaging value>

0x2C01:

1	Type	2 (Recursive average)
4	Signal1	01DIST1
18	Param1	<Averaging value>

Filters can also be applied to user signals.

8.3.2.40 Object 3CBFh: Sys Signals

3CBF	RECORD	Sys signals			
------	--------	-------------	--	--	--

Subindices

0	VAR	Number of entries	2	Unsigned8	ro
1	VAR	Range lower		FLOAT32	rw
2	VAR	Range upper		FLOAT32	rw

Reference to the SYSSIGNALRANGE command.

8.3.2.41 Object 3E00: User Signals

3E00	RECORD	User calc			
------	--------	-----------	--	--	--

Subindices

0	VAR	Number of entries	19	Unsigned8	ro
1	VAR	User calc 01		Visible string	ro
2	VAR	User calc 02		Visible string	ro
...					
13 _{hex}	VAR	User calc 18		Visible string	ro

Names of the user signals that are output in the 0x7C0xh objects. The sequence specifies the order of the PDO data. The PDOs are selected via the 0x1B0xh objects.

8.4 Mappable Objects – Process Data

Displays all individually available process data.

The objects 0x60xx, 0x700x and 0x7Cxx are structured as follows:

[INDEX]	[NAME]			
0	Subindex 0		Uin8	Read
1	Subindex 1		[DATA TYPE]	READ

Objects 0x60xx: Process data for channel 1.

Objects 0x700x: System process data (process data that are not available per channel).

Objects 0x7Cxx: Calculated process data.

- The process data for the objects are not yet available after switching on. Only a successful change of status from PreOP to SafeOP makes the process data available which were selected through object 0x1C13h or the mapping objects for the PDO output. If the status is changed from SafeOP to OP, all previously selected process data will still be available.

8.4.1 Object 6000, 6001: Distance Value

6000	RECORD	Channel 1 Distance 1			

Subindices

0	Number of entries	8	Unsigned8	ro
1	Channel 1 distance 1_OV00		Unsigned32	ro
2	Channel 1 distance 1_OV01		Unsigned32	ro
3	Channel 1 distance 1_OV02		Unsigned32	ro
4	Channel 1 distance 1_OV03		Unsigned32	ro
5	Channel 1 distance 1_OV04		Unsigned32	ro
6	Channel 1 distance 1_OV05		Unsigned32	ro
7	Channel 1 distance 1_OV06		Unsigned32	ro
8	Channel 1 distance 1_OV07		Unsigned32	ro

Object 0x6001 contains the value for the second distance value Distance 2 (DIST2).

For IFD2415, there are the additional objects for additional distance values

- 0x6002 contains Distance 3 (DIST3),
- 0x6003 contains Distance 4 (DIST4),
- 0x6004 contains Distance 5 (DIST5) and
- 0x6005 contains Distance 6 (DIST6).

8.4.2 Object 6010, 6011: Intensity

6010	RECORD	Channel 1 Intensity 1			

Subindices

0	Number of entries	8	Unsigned8	ro
1	Channel 1 intensity 1_OV00		Unsigned32	ro
2	Channel 1 intensity 1_OV01		Unsigned32	ro
3	Channel 1 intensity 1_OV02		Unsigned32	ro
4	Channel 1 intensity 1_OV03		Unsigned32	ro
5	Channel 1 intensity 1_OV04		Unsigned32	ro
6	Channel 1 intensity 1_OV05		Unsigned32	ro
7	Channel 1 intensity 1_OV06		Unsigned32	ro
8	Channel 1 intensity 1_OV07		Unsigned32	ro

Object 0x6011 contains the value for the second intensity value Intensity 2 of DIST2.

For IFD2415, there are the additional objects for additional intensity values

- 0x6012 contains Intensity 3 (DIST3),
- 0x6013 contains Intensity 4 (DIST4),
- 0x6014 contains Intensity 5 (DIST5) and
- 0x6015 contains Intensity 6 (DIST6).

8.4.3 Object 6030: Exposure Time

6030	RECORD	Channel 1 shutter			
Subindices					
0		Number of entries	8	Unsigned8	ro
1		Channel 1 shutter_OV00		Unsigned32	ro
2		Channel 1 shutter_OV01		Unsigned32	ro
3		Channel 1 shutter_OV02		Unsigned32	ro
4		Channel 1 shutter_OV03		Unsigned32	ro
5		Channel 1 shutter_OV04		Unsigned32	ro
6		Channel 1 shutter_OV05		Unsigned32	ro
7		Channel 1 shutter_OV06		Unsigned32	ro
8		Channel 1 shutter_OV07		Unsigned32	ro

8.4.4 Object 6050, 6051, 6052: Encoder

6050	RECORD	Channel 1 Encoder 1			
Subindices					
0		Number of entries	8	Unsigned8	ro
1		Channel 1 encoder 1_OV00		Unsigned32	ro
2		Channel 1 encoder 1_OV01		Unsigned32	ro
3		Channel 1 encoder 1_OV02		Unsigned32	ro
4		Channel 1 encoder 1_OV03		Unsigned32	ro
5		Channel 1 encoder 1_OV04		Unsigned32	ro
6		Channel 1 encoder 1_OV05		Unsigned32	ro
7		Channel 1 encoder 1_OV06		Unsigned32	ro
8		Channel 1 encoder 1_OV07		Unsigned32	ro

Object 0x6051 contains the values for encoder 2.

Object 0x6052 contains the values for encoder 3.

8.4.5 Object 6060: Peak Symmetry

The object is valid for the IFD2415.

6060	RECORD	Channel 1 Peak Symmetry			
Subindices					
0		Number of entries	8	Unsigned8	ro
1		Channel 1 peak symmetry 1_OV00		Unsigned32	ro
2		Channel 1 peak symmetry 1_OV01		Unsigned32	ro
3		Channel 1 peak symmetry 1_OV02		Unsigned32	ro
4		Channel 1 peak symmetry 1_OV03		Unsigned32	ro
5		Channel 1 peak symmetry 1_OV04		Unsigned32	ro
6		Channel 1 peak symmetry 1_OV05		Unsigned32	ro
7		Channel 1 peak symmetry 1_OV06		Unsigned32	ro
8		Channel 1 peak symmetry 1_OV07		Unsigned32	ro

Object 0x6060 contains the peak symmetry of DIST1.

The following objects contain additional symmetry values

- 0x6061 contains Peak symmetry 2 (DIST2),
- 0x6062 contains Peak symmetry 3 (DIST3),
- 0x6063 contains Peak symmetry 4 (DIST4),
- 0x6064 contains Peak symmetry 5 (DIST5),
- 0x6065 contains Peak symmetry 6 (DIST6).

8.4.6 Object 7000: Measured Value Counter

7000	RECORD	Counter			
Subindices					
0		Number of entries	8	Unsigned8	ro
1		Counter_OV00		Unsigned32	ro
2		Counter_OV01		Unsigned32	ro
3		Counter_OV02		Unsigned32	ro
4		Counter_OV03		Unsigned32	ro
5		Counter_OV04		Unsigned32	ro
6		Counter_OV05		Unsigned32	ro
7		Counter_OV06		Unsigned32	ro
8		Counter_OV07		Unsigned32	ro

8.4.7 Object 7001: Timestamp

7001	RECORD	Time stamp			
Subindices					
0		Number of entries	8	Unsigned8	ro
1		Time stamp_OV00		Unsigned32	ro
2		Time stamp_OV01		Unsigned32	ro
3		Time stamp_OV02		Unsigned32	ro
4		Time stamp_OV03		Unsigned32	ro
5		Time stamp_OV04		Unsigned32	ro
6		Time stamp_OV05		Unsigned32	ro
7		Time stamp_OV06		Unsigned32	ro
8		Time stamp_OV07		Unsigned32	ro

8.4.8 Object 7002: Measuring Rate

7002	RECORD	Frequency			
Subindices					
0		Number of entries	8	Unsigned8	ro
1		Frequency_OV00		Unsigned32	ro
2		Frequency_OV01		Unsigned32	ro
3		Frequency_OV02		Unsigned32	ro
4		Frequency_OV03		Unsigned32	ro
5		Frequency_OV04		Unsigned32	ro
6		Frequency_OV05		Unsigned32	ro
7		Frequency_OV06		Unsigned32	ro
8		Frequency_OV07		Unsigned32	ro

8.4.9 Object 7C00: Calculated Process Data

7C00	RECORD	User calc output			
Subindices					
0		Number of entries	8	Unsigned8	ro
1		User calc output 01_OV00		Unsigned32	ro
2		User calc output 01_OV01		Unsigned32	ro
3		User calc output 01_OV02		Unsigned32	ro
4		User calc output 01_OV03		Unsigned32	ro
5		User calc output 01_OV04		Unsigned32	ro
6		User calc output 01_OV05		Unsigned32	ro
7		User calc output 01_OV06		Unsigned32	ro
8		User calc output 01_OV07		Unsigned32	ro

The following objects contain additional process data:

0x7C01	User calc output 02	0x7C02	User calc output 03	0x7C03	User calc output 04
0x7C04	User calc output 05	0x7C05	User calc output 06	0x7C06	User calc output 07
0x7C07	User calc output 08	0x7C08	User calc output 09	0x7C09	User calc output 10
0x7C0A	User calc output 11	0x7C0B	User calc output 12	0x7C0C	User calc output 13
0x7C0D	User calc output 14	0x7C0E	User calc output 15	0x7C0F	User calc output 16
0x7C10	User calc output 17	0x7C11	User calc output 18	0x7C12	User calc output 19

8.5 Error Codes for SDO Services

If an SDO requirement is evaluated as negative, a corresponding error code is added to the “Abort SDO Transfer Protocol”.

Hexadecimal error code	Meaning
0503 0000	Toggle bit did not change.
0504 0000	SDO protocol timeout expired
0504 0001	Invalid command entered
0504 0005	Insufficient memory
0601 0000	Access to object (parameter) not supported
0601 0001	Attempt to read a “write-only parameter”
0601 0002	Attempt to write a “read-only parameter”
0602 0000	Object (parameter) is not listed in the object directory
0604 0041	Object (parameter) cannot be mapped to PDO
0604 0042	Number or length of the transfer objects exceeds the PDO length
0604 0043	General parameter incompatibility
0604 0047	General internal device incompatibility
0606 0000	Access denied due to a hardware error
0607 0010	Incorrect data type or length of the service parameter does not match
0607 0012	Incorrect data type or the service parameter is too long
0607 0013	Incorrect data type or the service parameter is too short
0609 0011	Sub-index does not exist
0609 0030	Invalid value for the parameter (only for write access)
0609 0031	Value of parameter too high
0609 0032	Value of parameter too low
0609 0036	Maximum value is below minimum value.
0800 0000	General error
0800 0020	Unable to transfer data to the application or unable to save data
0800 0021	Unable to transfer data to the application or unable to save data. Cause: local control
0800 0022	Unable to transfer data to the application or unable to save data. Cause: device state
0800 0023	Dynamic generation of the object directory failed or no object directory available

8.6 Oversampling

In operation without oversampling, the last acquired data record containing measured values is transmitted to the EtherCAT Master with each fieldbus cycle, see [Chap. 8.3.1.7](#). Therefore, many data records with measured values are not available for long fieldbus cycle periods. Configurable oversampling ensures that all (or selected) measurement data records are gathered and transmitted together to the master during the next fieldbus cycle.

The oversampling factor specifies how many samples are transmitted per bus cycle. For example, an oversampling factor of 2 means that 2 samples are transmitted per bus cycle.

With TxPDO mapping, the base index of the PDO mapping objects is included with oversampling factor 1. Use the following list to determine the index for selecting a different oversampling factor:

- Base index + 1: Oversampling factor 2
- Base index + 2: Oversampling factor 4
- Base index + 3: Oversampling factor 8

You can only select mapping objects with the same oversampling factor in 0x1C13h.

Example:

- The fieldbus/EtherCAT master operates at a cycle time of 1 ms because the higher-level PLC works with a cycle time of 1 ms, for example. This means that every 1 ms, one EtherCAT frame is sent to the IFD241x to pick up process data. If the measuring frequency in the IFD241x is set to 4 kHz, you need to specify an oversampling of 4.
- Startup procedure to output distance 1 for channel 1 (01DIST1) and distance 2 for channel 1 (01DIST2) with an oversampling factor of 4.
 - Distance 1 for channel 1 is output in object 6000h. In order to transfer this object in the PDO, the PDO mapping object 0x1A00 must be selected in object 0x1C13:01h. However, 0x1A02 (base index 0x1A00 + 2) must be selected for the 4-fold oversampling.

1A01:0	Ch01Dist1 TxPDOMap OV2	RO	> 2 <
1A02:0	Ch01Dist1 TxPDOMap OV4	RO	> 4 <
1A02:01	Subindex 001	RO	0x6000:01, 32
1A02:02	Subindex 002	RO	0x6000:01, 32
1A02:03	Subindex 003	RO	0x6000:01, 32
1A02:04	Subindex 004	RO	0x6000:01, 32
1A03:0	Ch01Dist1 TxPDOMap OV8	RO	> 8 <

- Distance 2 for channel 1 is output in object 6001h. In order to transfer this object in the PDO, the PDO mapping object 0x1A10 must be selected in object 0x1C13:02h. However, 0x1A12 (base index 0x1A10 + 2) must be selected for the 4-fold oversampling.

Sync Manager:

SM	Size	Type	Flags
0	256	MboxOut	
1	256	MboxIn	
2	0	Outputs	
3	32	Inputs	

PDO Zuordnung (0x1C13):

- 0x1A00 (excluded by 0x1A02)
- 0x1A01 (excluded by 0x1A02)
- 0x1A02
- 0x1A03 (excluded by 0x1A02)
- 0x1A08
- 0x1A09
- 0x1A0A
- 0x1A0B
- 0x1A10 (excluded by 0x1A12)
- 0x1A11 (excluded by 0x1A12)
- 0x1A12
- 0x1A13 (excluded by 0x1A12)

Download

PDO Zuordnung

PDO Konfiguration

PDO Liste:

Index	Size	Name
0x1A00	4.0	Ch01Dist1 OV1
0x1A01	8.0	Ch01Dist1 OV2
0x1A02	16.0	Ch01Dist1 OV4
0x1A03	32.0	Ch01Dist1 OV8
0x1A08	4.0	Ch02Dist1 OV1
0x1A09	8.0	Ch02Dist1 OV2
0x1A0A	16.0	Ch02Dist1 OV4
0x1A0B	32.0	Ch02Dist1 OV8
0x1A10	4.0	Ch01Dist2 OV1
0x1A11	8.0	Ch01Dist2 OV2
0x1A12	16.0	Ch01Dist2 OV4
0x1A13	32.0	Ch01Dist2 OV8
0x1A18	4.0	Ch02Dist2 OV1

PDO Inhalt (0x1A00):

Index	Size	Offs	Name
0x6000:01	4.0	0.0	CH01DIST
		4.0	

Predefined PDO Assignment: (keine)

Lade PDO Info aus dem Gerät

Sync Unit Zuordnung...

To ensure that no samples are lost due to the asynchronous nature between the master cycle and slave cycle, the master cycle time should always be less than the time for building a block from n samples.

An entire block with the specified samples is only made available to the EtherCAT side after all specified samples have been written to the block. If the time for filling a block is less than the master cycle time, individual blocks will not be transferred. It can indeed happen that the next block is already being filled with samples before the previously filled block is picked up in a master cycle.

Time for n samples < master cycle time

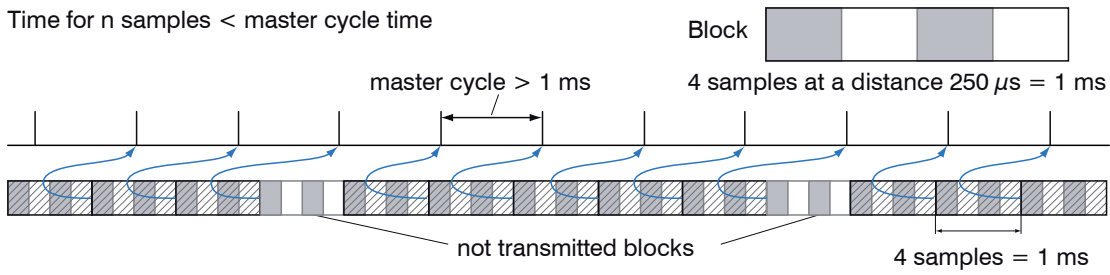

But if you select a number of samples sufficiently large that the time for filling a block is greater than the master cycle time, each block will be picked up in a master cycle. However, individual blocks (and therefore samples) will be transferred two or more times. This can be detected on the master side by transferring the timestamp or counter (see object 0x7000).

Time for n samples > master cycle time

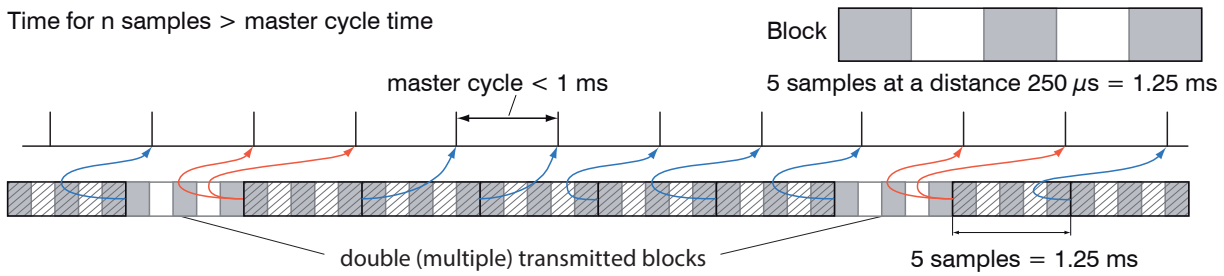

8.7 Calculation

8.7.1 Setting a Filter

The function for an average or median filter has already been explained, see [Chap. 8.3.2.39](#).

8.7.2 Thickness Calculation

Sequence for outputting a thickness (distance 1 to distance 2) in the PDO:

Steps 1 and 2 are not required when using the `Single side thickness` preset. To activate this preset, `Single side thickness` must be written to object 3022:01h, see [Chap. 8.3.2.7](#). Please note that this also modifies other settings.

➤ Step 1: Set the number of expected peaks to 2.

2156:0	Multilayer options ch 1	RO	> 2 <
2156:01	Peak count	RW	0x02 (2)
2156:02	Disable refractivity correction	RW	FALSE

➤ Step 2: Set up the calculation for object 2C00.

To do so, set sub-index 1 to 4h. The name for the generated signal is `THICK12`.

Formula for the calculation: $THICK12 = -1.0 \times 01DIST1 + 1.0 \times 01DIST2 + 0.0$ The factors and the offset must be defined accordingly:

2C00:0	Comp 1 ch1	RO	> 25 <
2C00:01	Type	RW	0x0004 (4)
2C00:02	Name	RW	THICK12
2C00:03	Signal1	RW	01DIST1
2C00:04	Signal2	RW	01DIST2
2C00:0D	Factor1	RW	-1.000000 (-1.000000e+000)
2C00:0E	Factor2	RW	1.000000 (1.000000e+000)
2C00:17	Offset	RW	0.000000 (0.000000e+000)
2C00:18	Param1	RW	0x00000000 (0)

➤ Step 3: Assigning a user-defined signal to a PDO

2E00h now includes the new signal name (all user-defined signals are displayed starting with sub-index 1).

2E00:0	User calc	RO	> 40 <
2E00:01	User calc 01	RO	THICK12
2E00:02	User calc 02	RO	
2E00:03	User calc 03	RO	
2E00:04	User calc 04	RO	
2E00:05	User calc 05	RO	
2E00:06	User calc 06	RO	
2E00:07	User calc 07	RO	
2E00:08	User calc 08	RO	
2E00:09	User calc 09	RO	
2E00:0A	User calc 10	RO	
7C00:0	UserCalcOutput01	RO	> 1 <
7C01:0	UserCalcOutput02	RO	> 1 <
7C02:0	UserCalcOutput03	RO	> 1 <
7C03:0	UserCalcOutput04	RO	> 1 <
7C04:0	UserCalcOutput05	RO	> 1 <
7C05:0	UserCalcOutput06	RO	> 1 <
7C06:0	UserCalcOutput07	RO	> 1 <
7C07:0	UserCalcOutput08	RO	> 1 <
7C08:0	UserCalcOutput09	RO	> 1 <
7C09:0	UserCalcOutput10	RO	> 1 <

➤ Step 4: Select PDO.

UserCalcOutput01 – 0x7C00h is selected with 0x1B00h:

1B00	UserCalc01 TxPDOMap
	UserCalcOutput01
	0x7C00
1B08	UserCalc02 TxPDOMap

Before PreOp is changed to SafeOp, the following must be selected in 0x1C13h and 0x1B00h:

0x1C13:00	0x00 (0)	clear sm pdos (0x1C13)
0x1C13:01	0x1B00 (6912)	download pdo 0x1C13:01 index
0x1C13:00	0x01 (1)	download pdo 0x1C13 count

8.8 Operational Modes

8.8.1 Free Run

There is no synchronization between the sensor and EtherCAT master. The PDOs are updated based on the internal measuring rate. The measuring rate is set using object 0x3251h. PDO frames may be lost or duplicated. Seamless transmission of the PDO frames to the EtherCAT master is only ensured if oversampling and measuring rate are in the correct ratio to the bus cycle, see [Chap. 8.6](#). You can use the measured value counter in 0x7000h or 0x1AE0h so that measured values are not evaluated twice because there is no synchronization.

8.8.2 Distributed Clocks SYNC0 Synchronization

Synchronization between the IFD241x and EtherCAT master takes place via the Sync0 cycle time. The PDOs are updated based on the Sync0 cycle time, which replaces the internal measuring rate. In this mode, an EtherCAT master can synchronize the data recording to the EtherCAT cycle time and synchronize the measurement data of multiple systems.

Note that even though the measurements in the IFD241x are synchronized to the Sync0 cycle time, the transmission of the values to the EtherCAT master is once again asynchronous with the bus cycle. Synchronous transmission of the values to the EtherCAT master is only ensured if oversampling and Sync0 cycle time are in the correct ratio to the bus cycle, see [Chap. 8.6](#).

Predefined SYNC0 cycle times are available in the ESI-XML file. However, any desired cycle time can be set within the limits of

- 10000000 ns to 125000 ns for the IFD2410 and IFD2411
- 10000000 ns to 50000 ns for the IFD2415

this parameter.

8.8.3 SM2/SM3 Synchronization

The sensor supplies current data to the EtherCAT master with every SM2 or SM3 event. Please note that the data of the PDOs are updated with the internal measuring rate independent of the bus cycle. This can cause PDO frames to be lost or duplicated. Seamless transmission of the PDO frames to the EtherCAT master is only ensured if oversampling and measuring rate are in the correct ratio to the bus cycle, see [Chap. 8.6](#).

8.9 Update

Two options are available to update the firmware of the IFD241x:

- Update via EoE (Ethernet over EtherCAT) or Telnet
- Update via FoE (File Access over EtherCAT)

8.9.1 Update via FoE

It is possible to perform an update of the IFD241x via FoE. For this purpose, a *.mef file is transferred to the sensor via FoE. To do so, the name and password of the file must correspond as follows:

Name: `confocalDT241x.mef`

Password: `0x00000000`

The IFD241x checks the beginning of the file during transmission. If the file is not in the correct format, the IFD241x will abort the transfer. After the file has been completely transferred, the IFD241x automatically starts the update, which disconnects the EtherCAT master.

8.9.2 Update via EoE

An update is performed via a *.meu file. The firmware update tool `Update_Sensor.exe` is required for this.

The current firmware is available at www.micro-epsilon.de/service/download/software.

To execute an update, you have to check Ethernet in the firmware update tool and enter the IP address, which you have configured via the EtherCAT master. With `Refresh` you can check if the sensor can be found on this IP address. Then select the *.meu file via `...` and confirm with `Send update`. First, the update is transmitted to the IFD241x. After transmission has been completed, the installation will start automatically. Do not disconnect the IFD241x from the power supply. The message `All updates successful` is displayed after the installation is complete. The IFD241x is ready for operation again.

8.10 Meaning of LEDs in EtherCAT Operation

LED	Color	Status	Meaning
RUN	Green	Off	Slave is in "Init" status
	Green	flashes uniformly	Slave is in "Pre-Operational" status
	Green	flashes briefly	Slave is in "Safe-Operational" status
	Green	flashes rapidly	Slave is in "Initialization" or "Bootstrap" status
	Green	illuminated	Slave is in "Operational" status
ERR	Red	Off	no error
	Red	flashes uniformly	invalid configuration
	Red	flashes briefly	Unintentional change in status
	Red	flashes twice	Application watchdog timeout
	Red	flickers	Boot error
	Red	illuminated	PDI watchdog timeout

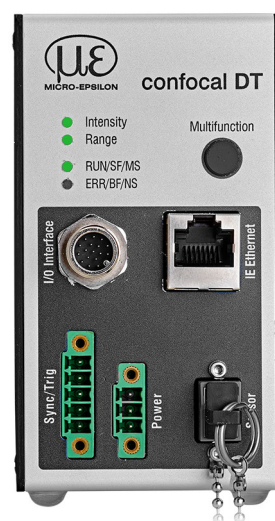

8.11 EtherCAT Configuration with the Beckhoff TwinCAT® Manager

The Beckhoff TwinCAT Manager can be used as EtherCAT master on the PC.

The device description files (EtherCAT® Slave Information) can be found online at www.micro-epsilon.de/download/software/:

- Micro-Epsilon_IFC241x.xml for IFD2411
- Micro-Epsilon_IFD241x.xml for IFD2410/2415

- Copy the device description file into the directory C:\TwinCAT\3.1\Config\Io\EtherCAT before the measuring device can be configured using EtherCAT®.
- Delete any existing older files.

EtherCAT® slave information files are XML files which specify the characteristics of the slave device for the EtherCAT® Master and contain information on the communication objects supported.

- Restart the TwinCAT Manager after copying.

Search for a device:

- Select the tab I/O Devices, then Scan.
- Confirm with OK.
- Select a network card on which you want to search for EtherCAT® slaves.

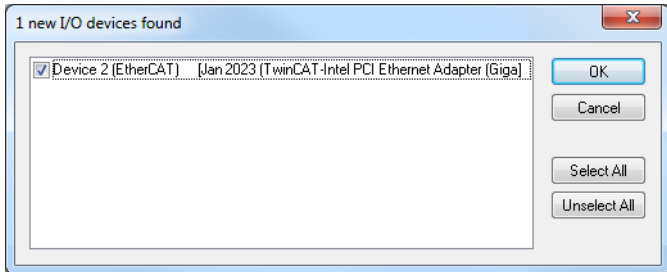

- Confirm with OK.

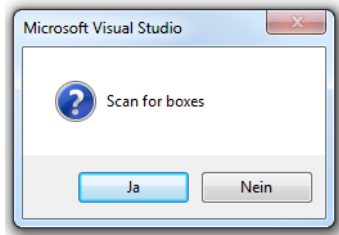

The "Scan for boxes" window appears (EtherCAT® slaves).

- Confirm with Yes.

The IFD241x is now listed in a list.

- Now confirm the Activate Free Run window with Yes.

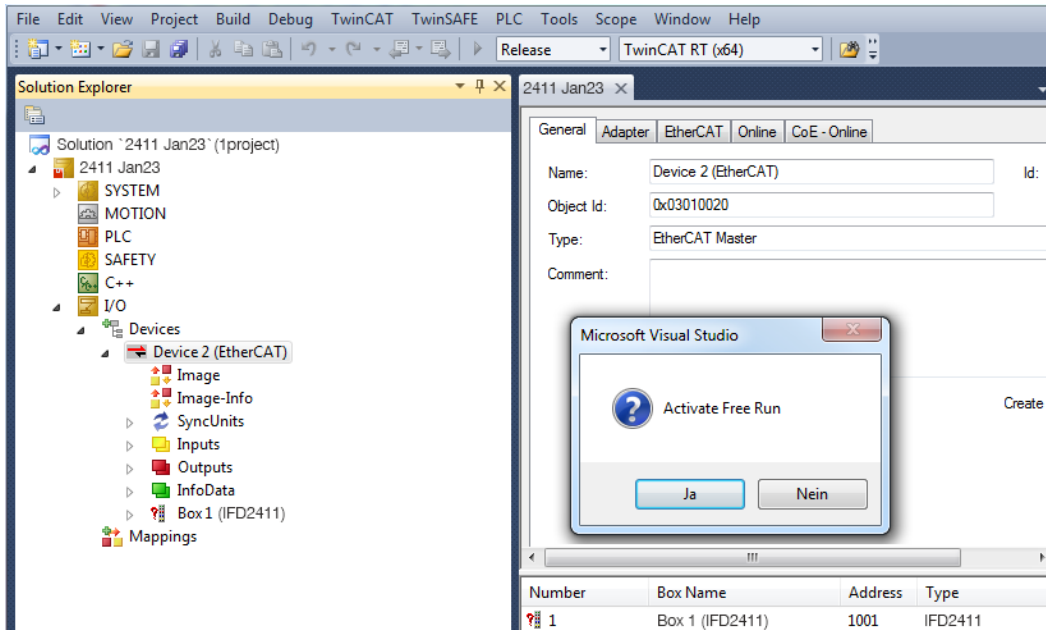

The current status should be at least PREOP, SAFEOP or OP on the Online page.

In the event that ERR PREOP appears in `Current Status`, the cause is reported in the message window. This will be the case if the settings for the PDO mapping in the IFD241x are different from the settings in the ESI file (device description file).

In the delivery state for the measuring device, only one measured value (distance 1) is set as the output variable (both in the IFD241x and in the ESI file).

Further data can be selected in the Process Data tab.

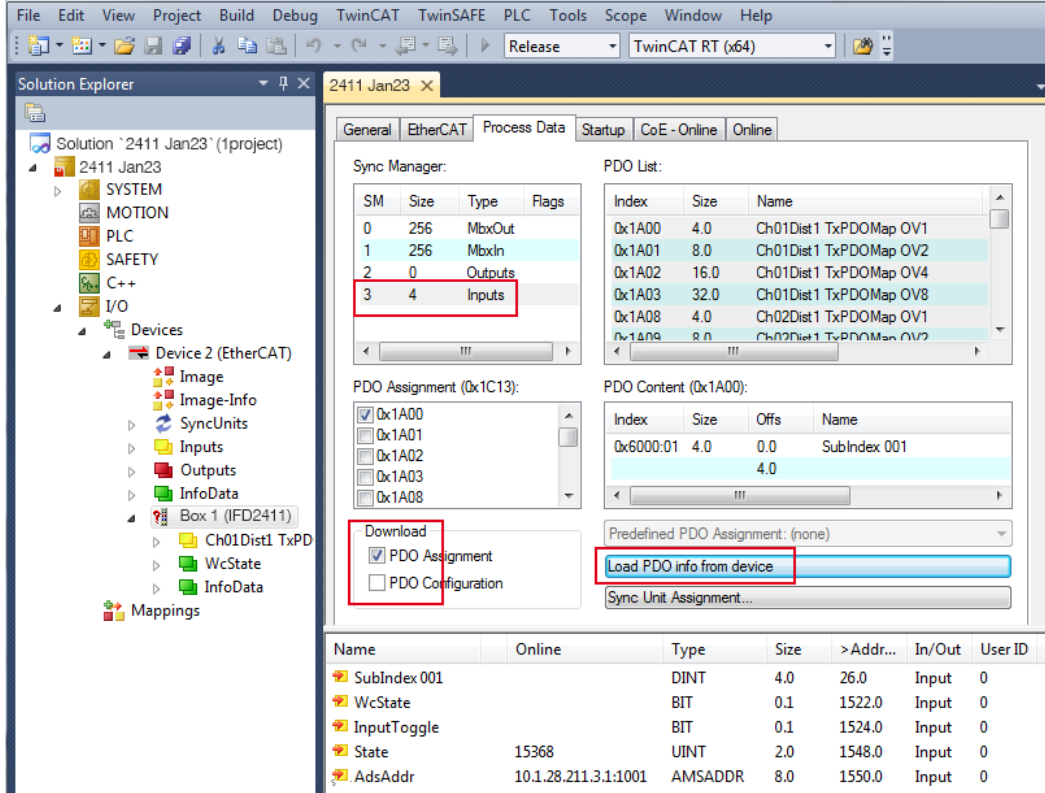

The scope of the process data provided and the assignment of the SyncManager can now be viewed.

➡ Now select the tab `Restart TwinCAT (Config Mode)` under the `TwinCAT` menu item.

The configuration is now complete.

In `SAFEOP` and `OP` status, the selected measured values are transferred as process data.

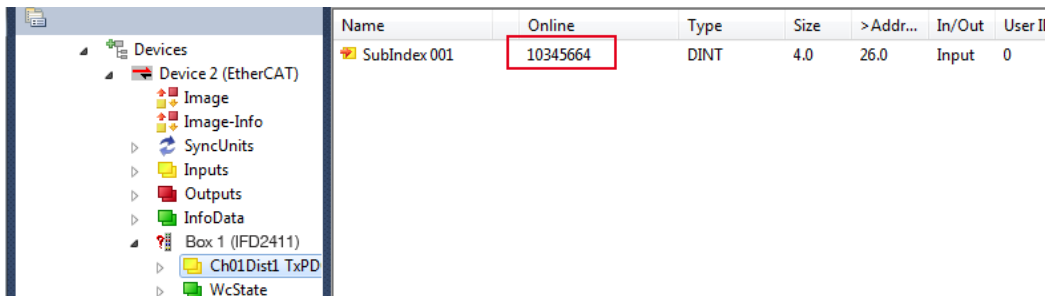

9. Error, Repair

9.1 Web Interface Communication

- ▶ If an error page is displayed in the web browser, please check the following points.
 - Check to make sure the controller is connected correctly, see [Chap. 5.1](#).
 - Check the IP configuration of PC and controller, find the controller with the `sensorTOOL` program, see [Chap. 5.1](#). If the controller and PC are connected directly, it can take up to two minutes for them to agree on the IP addresses.
 - Check proxy settings used. If the controller is connected to the PC via a separate network card, then it will be necessary to disable the use of a proxy server for this connection. Please ask your network manager or administrator about this!

9.2 Changing the Sensor Cable on the Sensors

- ▶ Loosen the protective sleeve on the sensor. Remove the defective sensor cable.
- ▶ Feed the new sensor cable through the protective sleeve.
- ▶ Remove the protective cap on the sensor cable and save it for safe keeping.
- ▶ Guide the guide lug of the sensor connector into the groove of the port.
- ▶ Screw the sensor plug and sensor port together.
- ▶ Screw the protective sleeve back onto the sensor.



- ▶ Conduct a dark correction, see [Chap. 5.10](#).

9.3 Replacing the Protective Glass on the Sensors

The protective glass must be replaced in case of:

- irreversible contamination,
- scratches.

! The sensor may not be used without a protective glass, as doing so will impair its measuring accuracy.

- ▶ Loosen the front frame incl. protective glass on the sensor.



- ▶ Remove the seal and insert the O-ring into the frame groove of the new protective glass.
- ▶ Screw the new frame incl. protective glass back onto the sensor.

10. Software Support with MEDAQLib

MEDAQLib is a documented driver DLL. This allows you to integrate the confocal measuring system into existing PC software or that of the customer.

Connection options:

- RS422/USB converter (optional accessories) and suitable PC2415-x/OE connection cable for IFD2410/2415 or SC2415-x/OE for IFC2411.

No knowledge of the underlying protocol of the respective controller is necessary to be able to contact the controller. The individual commands and parameters for the controller to be addressed are set via an abstract function and converted into the protocol of the controller by the MEDAQLib accordingly.

MEDAQLib

- contains a DLL that can be imported into C, C++, VB, Delphi and many other programs,
- takes care of data conversion for you,
- works regardless of the type of interface used,
- uses the same functions for communication (commands),
- provides a single transmission format for all MICRO-EPSILON sensors.

For C/C++ programmers, an additional header file and a library file are integrated into MEDAQLib.

You can find the current driver routine including documents at:

www.micro-epsilon.com/download

www.micro-epsilon.de/link/software/medaqlib

11. Disclaimer

All components of the device have been checked and tested for functionality in the factory. However, should any defects occur despite careful quality control, these shall be reported immediately to MICRO-EPSILON or to your distributor / retailer.

MICRO-EPSILON undertakes no liability whatsoever for damage, loss or costs caused by or related in any way to the product, in particular consequential damage, e.g., due to

- non-observance of these instructions/this manual,
- improper use or improper handling (in particular due to improper installation, commissioning, operation and maintenance) of the product,
- repairs or modifications by third parties,
- the use of force or other handling by unqualified persons

This limitation of liability also applies to defects resulting from normal wear and tear (e.g., to wearing parts) and in the event of non-compliance with the specified maintenance intervals (if applicable).

MICRO-EPSILON is exclusively responsible for repairs. It is not permitted to make unauthorized structural and/or technical modifications or alterations to the product. In the interest of further development, MICRO-EPSILON reserves the right to modify the design.

In addition, the General Terms of Business of MICRO-EPSILON shall apply, which can be accessed under Legal details | Micro-Epsilon <https://www.micro-epsilon.com/impressum/>. For translations into other languages, the German version shall prevail.

12. Service, Repair

If the sensor, controller or sensor cable is defective:

- If possible, save the current sensor settings in a parameter set, see [Chap. 5.9](#) to reload them into the controller after the repair.
- Please send us the affected parts for repair or exchange.

If the cause of a fault cannot be clearly identified, please send the entire measuring system to:

MICRO-EPSILON
MESSTECHNIK GmbH & Co. KG
Königbacher Str. 15
94496 Ortenburg / Germany

Tel. +49 (0) 8542 / 168-0
Fax +49 (0) 8542 / 168-90
info@micro-epsilon.com
www.micro-epsilon.com

13. Decommissioning, Disposal

To prevent environmentally harmful substances from being released and to ensure the reuse of valuable raw materials, please note the following rules and obligations:

- All cables must be removed from the sensor and/or controller.
- The sensor and/or controller, its components and the accessories, as well as the packaging materials, are to be disposed of according to the country-specific waste treatment and disposal regulations for the respective area of use.
- You are obligated to observe all relevant national laws and provisions.

The following (disposal) instructions apply in Germany / the EU:

- old devices labeled with a crossed-out garbage can must not be disposed of in normal waste (e.g. garbage can or yellow bin) and must be disposed of separately. This prevents hazards to the environment due to improper disposal and proper further use of the old devices is ensured. 
- A list of national legislation and contacts in EU Member States can be found at https://ec.europa.eu/environment/topics/waste-and-recycling/waste-electrical-and-electronic-equipment-weee_en. Here you have the opportunity to learn about the respective national collection and return points.
- Old devices can also be sent back to MICRO-EPSILON for disposal, to the address provided in the Legal Notice at <https://www.micro-epsilon.com/impressum/>.
- Please note that you yourself are responsible for deleting the measurement-specific and personal data from the old devices being disposed of.
- We are registered as a manufacturer of electrical and/or electronic devices under registration number WEEE-Reg.-Nr. DE28605721 with Stiftung Elektro-Altgeräte Register, Nordostpark 72, 90411 Nuremberg.

Appendix

A 1 Optional accessories, services

A 1.1 Optional accessories confocalDT IFD2410/2415

SC2415-x/OE	Connection cable with 17-pole M12 socket and open ends for analog output, digital I/O and encoder; drag chain-compatible, cable length x = 3 m, 6 m, 9 m or 15 m
PC2415-x	Cable extension with 12-pole M12 socket and 12-pole M12 plug for supply, RS422 or encoder, Industrial Ethernet; drag chain-compatible, cable length x = 3 m, 6 m, 9 m or 15 m
PC2415-x/OE	Connection cable with 12-pole M12 socket and open ends, suitable for PC2415-x, supply, RS422 or encoder, Industrial Ethernet; drag chain-compatible, cable length x = 3 m, 6 m, 9 m or 15 m
IF2001/USB	Converter from RS422 to USB, type: IF2001/USB, suitable for PC2415-x/OE cable, including driver, Connections: 1x 10-pin socket strip (cable clamp), type: Würth 691361100010; 1x 6-pin socket strip (cable clamp), type: Würth 691361100006
PS2020	Power supply for DIN rail installation, input 230 VAC, output 24 VDC/2.5 A

A 1.2 Optional Accessories confocalDT IFD2411

Cable C2401 with FC/APC and E2000/APC connector

C2401-x	Optical fiber (3 m, 5 m, 10 m, customer-specific length up to 50 m)
C2401/PT-x	Optical fiber with protective sleeve for mechanical strain (3 m, 5 m, 10 m, customer-specific length up to 50 m)
C2401-x(01)	Optical fiber core diameter 26 μ m (3 m, 5 m, 15 m)
C2401-x(10)	Optical fiber in drag chain-compatible design (3 m, 5 m, 10 m)

Mounting adapter

MA2400-27	Mounting adapter for IFS2404-1 / IFS2404-3 / IFS2404-6 sensors
MA2404-12	Mounting adapter for IFS2404-2(001) / IFS2404/90-2(001) sensors
JMA-xx	Adjustable mounting adapter, see Chap. A 3

Other accessories

SC2415-x/OE	Connection cable with 17-pole M12 socket and open ends for analog output, digital I/O and encoder; drag chain-compatible, cable length x = 3 m, 6 m, 9 m or 15 m
IF2001/USB	Converter from RS422 to USB, type: IF2001/USB, suitable for SC2415-x/OE cable, including driver, Connections: 1x 10-pin socket strip (cable clamp), type: Würth 691361100010; 1x 6-pin socket strip (cable clamp), type: Würth 691361100006
PS2020	Power supply for DIN rail installation, input 230 VAC, output 24 VDC/2.5 A

Vacuum feedthrough

C2402/Vac/KF16	Vacuum feedthrough for optical fiber, 1 channel, vacuum-side FC/APC, non-vacuum-side E2000/APC, clamping flange type KF 16
C2405/Vac/1/KF16	Vacuum feedthrough on both sides FC/APC socket, 1 channel, clamping flange type KF 16
C2405/Vac/1/CF16	Vacuum feedthrough on both sides FC/APC socket, 1 channel, flange type CF 16
C2405/Vac/6/CF63	Vacuum feedthrough for optical fiber on both sides FC/APC socket, 6 channels, flange type CF 63

A 1.3 Services

- confocalDT measuring system linearity check and adjustment
- confocalDT measuring system calibration

A 2 Factory Settings

A 2.1 confocalDT IFD2410/2415

Number of Peaks	1 measured value, highest peak
Region of interest	Range start corresponds to 0 % Range end corresponds to 100 %
Exposure mode	Measurement mode
User group	Professional, password "000"
Data reduction	Inactive
Detection Threshold	2%
Error handling	Error output, no measured value
Measuring program	Distance measurement, "Standard matt"
Measuring Rate	1 kHz
Peak modulation	50 %

A 2.2 confocalDT IFD2411

Number of Peaks	1 measured value, highest peak
Region of interest	Range start corresponds to 0 % Range end corresponds to 100 %
Exposure mode	Measurement mode
User group	Professional, password "000"
Data reduction	Inactive
Detection Threshold	2%
Error handling	Error output, no measured value
Measuring program	Distance measurement, "Standard matt"
Measuring Rate	1 kHz
Peak modulation	50 %

RS422	921.6 kBps
Switching output 1	Intensity error, switching level in case of error: Push Pull
Switching output 2	Measuring range error, switching level in case of error: Push Pull
Interface	EtherCAT
Signal Processing	01DIST1, moving averaging, 16 values
Synchronization	no synchronization
Key function	Change operating mode, dark correction, factory setting
Key Lock	Inactive
Trigger mode	No trigger

RS422	921.6 kBps
Interface	EtherCAT
Signal Processing	01DIST1, moving averaging, 16 values
Synchronization	no synchronization
Key function	Change operating mode, dark correction, factory setting
Key Lock	Inactive
Trigger mode	No trigger

A 3 Adjustable Mounting Adapter JMA-xx

A 3.1 Functions

- Supports optimal sensor alignment for best possible measurement results
- Manual adjustment mechanism for easy and fast adjustment
 - Shift in X/Y: ± 2 mm
 - Tilt angle: $\pm 4^\circ$
- High resistance to shocks and vibrations due to radial clamping allows integration into machines
- Compatible with numerous confocalDT and interferoMETER sensor models

A 3.2 Sensor Mounting, Compatibility

Radial clamping for sensors with

$\varnothing 12$ mm

Reducing sleeve

Adapter D27-D12

Sensor

- IFD2411-2

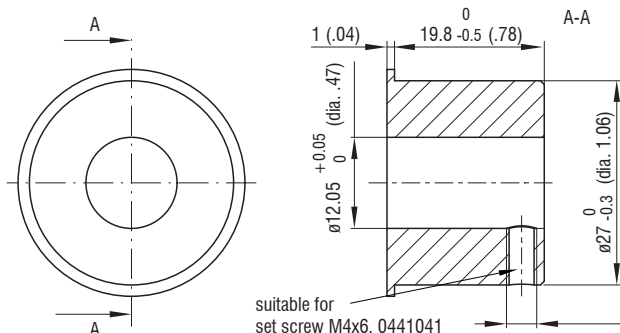

$\varnothing 27$ mm

Sensor

- IFD2411-1
- FD2411-3
- IFD2411-6

A 3.3 Mounting

- ▶ Mount the sensor in the mounting ring, see figure.
- ▶ Use reducing sleeves for sensors with an outer diameter of less than 27 mm.
- ▶ Mount the mounting adapter with screws type M4, see dimensional drawing.

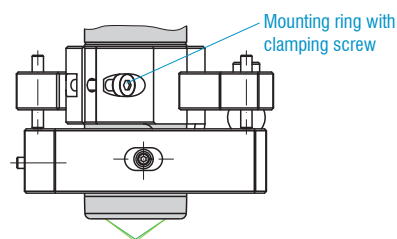

A 3.4 Dimensional Drawing of Mounting Adapter

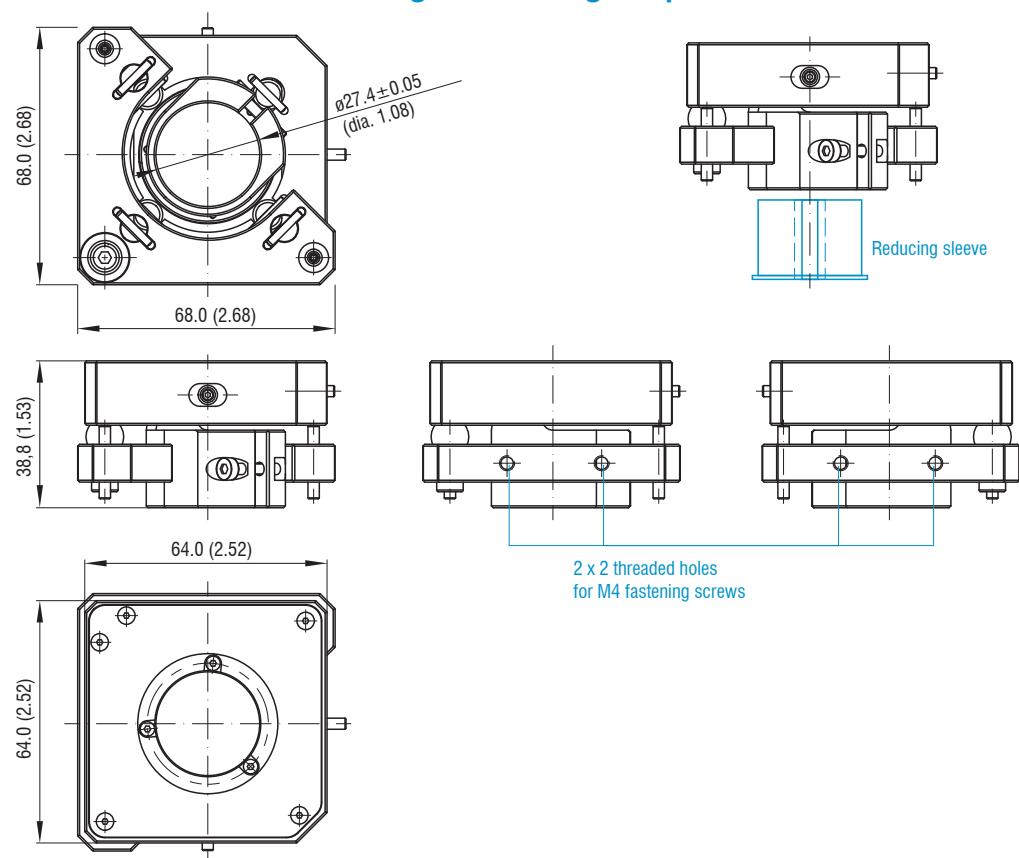

A 3.5 Perpendicular Alignment of Sensor

➤ With the light source switched on, align the sensor with the measuring object.

Horizontal shift ± 2 mm



Shift to the left:

➤ Turn the hexagon socket screw clockwise

Shift to the right:

➤ Turn the hexagon socket screw counterclockwise

Horizontal tilt angle $\pm 4^\circ$



Tilt to the left:

➤ Turn the hexagon socket screw clockwise

Tilt to the right:

➤ Turn the hexagon socket screw counterclockwise

Vertical shift ± 2 mm

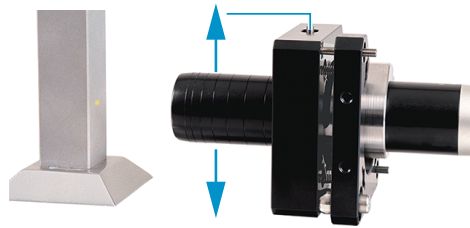

Shift downwards:

➤ Turn the hexagon socket screw clockwise

Shift upwards:

➤ Turn the hexagon socket screw counterclockwise

Vertical tilt angle $\pm 4^\circ$

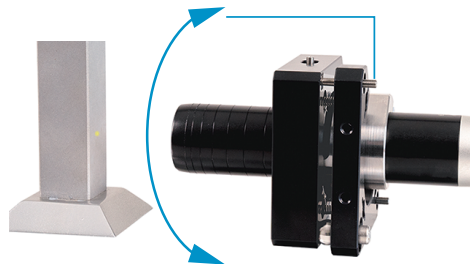

Shift downwards:

➤ Turn the hexagon socket screw clockwise

Shift upwards:

➤ Turn the hexagon socket screw counterclockwise

A 4 Cleaning Optical Components

A 4.1 Contamination

Contamination of optical surfaces and components can increase the dark value and affect sensitivity and accuracy. To prevent this, it is necessary to clean the optical components and record the dark value. “Dark value” refers to the interfering reflections at boundary surfaces along the optical signal path. At each boundary surface or material transition, the light waves are reflected to a certain extent at the transition and travel back in the fiber optics. The interfering signal overlaps with the useful signal and forms a kind of signal noise.

If the interference signal is sufficiently high and the useful signal is relatively weak, the useful signal can no longer be clearly identified. This may cause the controller to confuse a dark value peak with the measurement signal. Thus the calculated distance of the measuring object does not match the actual one.

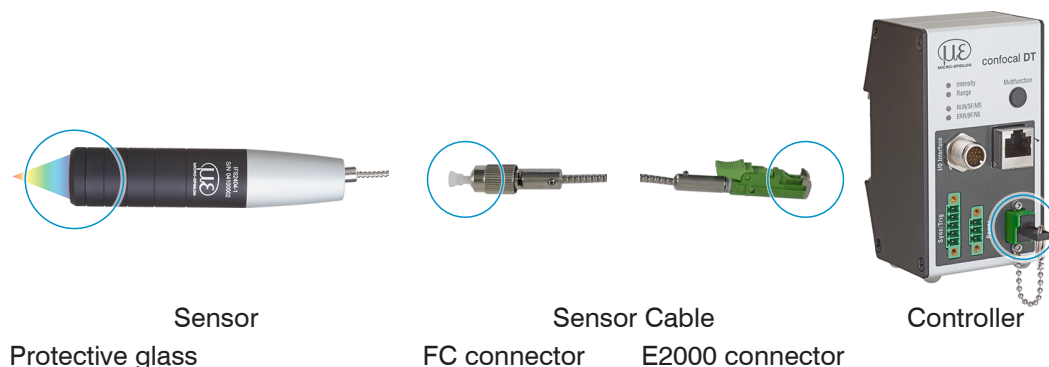
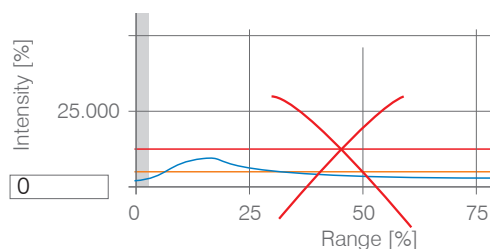
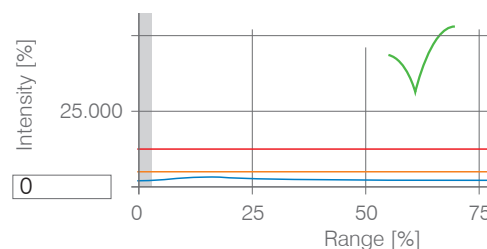

Fig. 126 Optical boundary surfaces of a confocal measuring system

➡ Conduct a dark correction, see [Chap. 5.10](#).



Video signal before dark correction (high dark value, blue line)







Video signal after dark correction

If the video signal corresponds to the condition before the dark correction, you must clean the optical boundary surfaces within the measuring system. Clean the optical surfaces one by one to find the dirty component. You can observe how cleaning improves the result by watching the dark signal of the video signal.

➡ Continue with the section `Protective Glass of Sensor`.

- Check and clean the protective glass of the sensor at regular intervals depending on the operating conditions.
- i Clean the system starting from the controller to the sensor. Always clean both components of a matched pair, i.e. plug and socket.

A 4.2 Tools and Cleaning Agents

One-Click™ Cleaner	Isopropyl alcohol	Q-Tip, suitable for clean rooms	Pressurized gas, dry and oil-free
			
For FC or E2000 type plug or socket	For the protective glass of the sensor	Use with isopropyl alcohol for protective glass of the sensor	Removes loose particles

A 4.3 Sensor Protective Glass

Loose particles

- Blow off loose particles with dry, oil-free pressurized air.

Stuck particles

- Clean the protective glass with a clean, soft, lint-free cloth or lens cleaning paper and pure alcohol (isopropyl alcohol).

For sensors with a small protective glass, e.g., the IFS2404-2(001) series:

- Soak a Q-Tip in isopropyl alcohol. Slowly rub the Q-Tip with a circular motion on the protective glass.

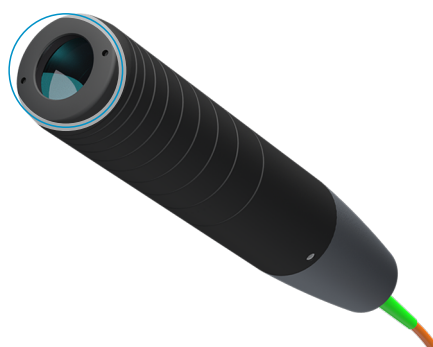

Fig. 127 Cross-section of protective glass

- Conduct a dark correction.

If the video signal corresponds to the condition before the dark correction, you must clean the boundary surfaces within the measuring system.

- Continue with the section `Interface between Controller and Sensor Cable`.

A 4.4 Interface between Controller and Sensor Cable

- ▶ Disconnect the sensor cable (fiber optic cable) from the controller.
- ▶ Remove the protective cap of the One-Click™ cleaner.
- ▶ Put the One-Click™ cleaner into the fiber optic connector of the controller, see figure.
- ▶ Press the outer sleeve of the One-Click™ cleaner onto the fiber optic connector until a click noise signals the end of cleaning.



Fig. 128 One-Click™ Cleaner for cleaning E2000 optical fiber transitions

- ▶ Plug the protective front cap on the controller into the optical fiber connection.
- ▶ Remove the front protective cap of the One-Click™ cleaner.
- ▶ Put the One-Click™ cleaner into the optical fiber, see figure.
- ▶ Press the outer sleeve of the One-Click™ cleaner onto the fiber optic connector until a click noise signals the end of cleaning.

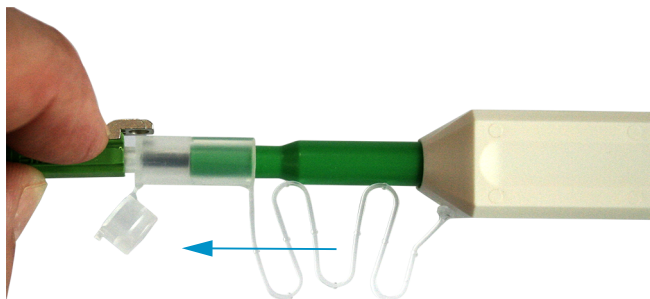

- ▶ Plug the sensor cable into the controller.
- ▶ Conduct a dark correction.

If the video signal corresponds to the condition before the dark correction, you must clean the boundary surfaces within the measuring system.

- ▶ Continue with the section [Interface between Sensor Cable and Sensor](#).

A 4.5 Interface between Sensor Cable and Sensor

- ▶ Remove the sensor cable (fiber optic cable) from the sensor.
- ▶ Remove the front protective cap of the One-Click™ cleaner.
- ▶ Put the One-Click™ cleaner into the optical fiber, see figure.
- ▶ Press the outer sleeve of the One-Click™ cleaner onto the fiber optic connector until a click noise signals the end of cleaning.

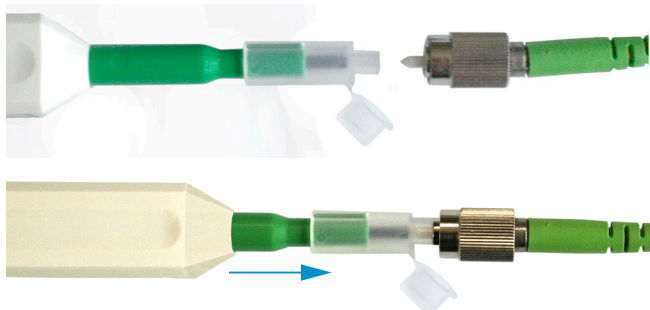

- ▶ Plug a protective cap onto the optical fiber.

Sensor with optical fiber in the sensor:

- ▶ Remove the protective cap of the One-Click™ cleaner.
- ▶ Put the One-Click™ cleaner into the sensor, see figure.
- ▶ Press the outer sleeve of the One-Click™ cleaner onto the sensor until a click noise signals the end of cleaning.



- ▶ Put the sensor cable and sensor together.
- ▶ Conduct a dark correction.

If the video signal corresponds to the condition before the dark correction, you must clean the boundary surfaces within the measuring system.

- ▶ Continue with the section `Interface between Controller and Sensor Cable`.

A 4.6 Preventive Protection

Sensors and controllers of a confocal chromatic sensor system are supplied with protective caps. This prevents dust or similar contaminants from being deposited at the optical boundary surfaces.

- ▶ Cover all optical fiber connections immediately when replacing sensors or disconnecting a sensor cable from the controller.



A 5 ASCII Communication with Controller

A 5.1 General

The ASCII commands can be sent to the controller via the RS422 interface or Ethernet (Port 23). All commands, inputs and error reports are in English. A command always consists of the command name and zero or several parameters that are separated with a space and end in LF. If spaces are used in parameters, the parameter must be placed in quotation marks, e.g. "Password with space".

Example: Switching on output via RS422

OUTPUT RS422 ↵

Note: ↵ Must contain LF, but can also be CR LF.

Explanation: LF Line feed (hex 0A)

CR Carriage return (hex 0D)

↵ Enter (depending on system, hex 0A or hex 0D0A)

The currently set parameter value is reset if a command is invoked without parameters.

The output format is:

<Command name> <Parameter1> [<Parameter2> [...]]

The response can be used again without changes as a command for setting the password. Optional parameters are only returned as well if this is necessary.

After a command is processed, a line break and a prompt ("->") is always returned. In the event of an error, an error message beginning with Exx, where xx stands for a unique error number, comes before the prompt. Moreover, instead of error messages, warning messages ("Wxx") may be output. Warnings are structured like error messages, such as "If Xenon lamp is too hot...". Warnings do not prevent commands from being executed.

A 5.2 Commands Overview

Group	Chapter	Command	Brief information
General			
	Chap. A 5.3.1.1	HELP	Help
	Chap. A 5.3.2.2	GETINFO	Controller information
	Chap. A 5.3.1.3	ECHO	Reply type
	Chap. A 5.3.1.4	PRINT	Parameter overview
	Chap. A 5.3.1.5	SYNC	Synchronization
	Chap. A 5.3.1.6	TERMINATION	Termination resistor
	Chap. A 5.3.1.7	RESET	Boot sensor
	Chap. A 5.3.1.8	RESETCNT	Reset counter
User level			
	Chap. A 5.3.2.1	LOGIN	Change user level
	Chap. A 5.3.2.2	LOGOUT	Change to user level User
	Chap. A 5.3.2.3	GETUSERLEVEL	User level query
	Chap. A 5.3.2.4	STDUSER	Set standard user
	Chap. A 5.3.2.5	PASSWD	Change password
Inputs			
	Chap. A 5.3.3	MFILEVEL	Input level multifunction inputs

Sensor			
	Chap. A 5.3.4.1	SENSORTABLE	Display available sensors
	Chap. A 5.3.4.2	SENSORINFO	Information on sensor
	Chap. A 5.3.4.3	DARKCORR	Start dark correction
	Chap. A 5.3.4.4	LED	LED on/off
	Chap. A 5.3.4.5	LEDSOURCE	Control input measurement light source
Triggering			
	Chap. A 5.3.5.1	TRIGGERSOURCE	Trigger source
	Chap. A 5.3.5.2	TRIGGERAT	Effect of trigger input
	Chap. A 5.3.5.3	TRIGGERMODE	Trigger type
	Chap. A 5.3.5.4	TRIGGERLEVEL	Active level of trigger input
	Chap. A 5.3.5.5	TRIGGERSW	Generates a software trigger pulse
	Chap. A 5.3.5.6	TRIGGERCOUNT	Number of measured values to be specified
	Chap. A 5.3.5.7	TRIGINLEVEL	Trigger Level TrigIn (TTL / HTL)
	Chap. A 5.3.5.8	TRIGGERENCSTEPSIZE	Step Size Encoder Triggering
	Chap. A 5.3.5.9	TRIGGERENCMIN	Minimum Encoder Triggering
	Chap. A 5.3.5.10	TRIGGERENCMAX	Maximum Encoder Triggering
Encoder			
	Chap. A 5.3.6.1	META_ENCODERCOUNT	Number of Available Encoders
	Chap. A 5.3.6.2	ENCINTERPOLn	Setting Interpolation Depth
	Chap. A 5.3.6.3	ENCREFn	Setting the Reference Track
	Chap. A 5.3.6.4	ENCVALUEn	Setting Encoder Value
	Chap. A 5.3.6.5	ENCSET	Setting Encoder
	Chap. A 5.3.6.6	ENCRESET	Reset Encoder Value
	Chap. A 5.3.6.7	ENCMAXn	Setting Maximum Encoder Value
	Chap. A 5.3.6.8	ENCODERCOUNT	Number of Active Encoders
Interface			
	Chap. A 5.3.7	BAUDRATE	Setting RS422
Parameter Management, Load/Save Settings			
	Chap. A 5.3.8.1	BASICSETTINGS	Load Connection Settings
	Chap. A 5.3.8.2	CHANGESETTINGS	Show Changed Parameters
	Chap. A 5.3.8.3	EXPORT	Export Parameter Sets
	Chap. A 5.3.8.4	IMPORT	Import Parameter Sets
	Chap. A 5.3.8.5	SETDEFAULT	Set Factory Settings
	Chap. A 5.3.8.6	MEASSETTINGS	Edit Measurement Settings
Measurement			
	Chap. A 5.3.9.1	PEAKCOUNT	Number of Measurement Peaks
	Chap. A 5.3.9.2	MEASPEAK	Peak selection
	Chap. A 5.3.9.3	REFRACCORR	Refractivity Correction
	Chap. A 5.3.9.4	SHUTTERMODE	Exposure mode
	Chap. A 5.3.9.5	MEASRATE	Measuring frequency
	Chap. A 5.3.9.6	SHUTTER	Exposure time
	Chap. A 5.3.9.7	ROI	Range of interest
	Chap. A 5.3.9.8	MIN_THRESHOLD	Minimum Threshold Peak Detection
	Chap. A 5.3.9.9	PEAK_MODULATION	Modulation of Peaks

Material database			
	Chap. A 5.3.10.1	MATERIALTABLE	Material table
	Chap. A 5.3.10.2	MATERIAL	Select material
	Chap. A 5.3.10.3	MATERIALINFO	Show Material Property
	Chap. A 5.3.10.4	META_MATERIAL	Existing Materials, Material Names
	Chap. A 5.3.10.5	META_MATERIAL_PROTECTED	Protected Materials
	Chap. A 5.3.10.6	MATERIALEDIT	Edit Material Table
	Chap. A 5.3.10.7	MATERIALDELETE	Delete material
	Chap. A 5.3.10.8	MATERIALADD	Add Material
Edit measured value			
	Chap. A 5.3.11.1	STATISTIC	Selection of Signals for Statistics
	Chap. A 5.3.11.2	META_STATISTIC	List of Possible Statistics Signals
	Chap. A 5.3.11.3	STATISTICSIGNAL	Selection of Statistics signal
	Chap. A 5.3.11.4	META_STATISTICSIGNAL	List of Possible Statistics Signals to Select
	Chap. A 5.3.11.5	META_MASTERSIGNAL	List of Possible Signals to be Parameterized
	Chap. A 5.3.11.6	MASTERSIGNAL	Parameterization of Master Signals
	Chap. A 5.3.11.7	META_MASTER	List of Possible Signals for Mastering
	Chap. A 5.3.11.8	MASTER	Trigger Mastering
	Chap. A 5.3.11.9	MASTERSIGNALSELECT	Determine Signal for Mastering with External Source
	Chap. A 5.3.11.10	MASTERSOURCE	Select External Source for Mastering
	Chap. A 5.3.11.11	COMP	Calculation in Channel
	Chap. A 5.3.11.12	META_COMP	List of Possible Calculation Signals
	Chap. A 5.3.11.13	SYSSIGNALRANGE	Two-Point Scaling Data Outputs
Data Output			
	Chap. A 5.3.12.1	OUTPUT	Digital Output Selection
	Chap. A 5.3.12.2	OUTREDUCEDEVICE	Output Data Rate
	Chap. A 5.3.12.3	OUTREDUCECOUNT	Reduction Counter
	Chap. A 5.3.12.4	OUTHOLD	Error Handling
Selection of Measured Values to be Output via Interfaces			
	Chap. A 5.3.13.2	OUT_RS422	Data Selection for RS422
	Chap. A 5.3.13.3	META_OUT_RS422	List of Possible Signals RS422
	Chap. A 5.3.13.4	GETOUTINFO_RS422	List of Selected Signals, Sequence via Rs422
Switching Outputs			
	Chap. A 5.3.14.2	ERROROUTn	Selection of Error Signal for Output
	Chap. A 5.3.14.3	META_ERRORLIMITSIGNAL	List of Possible Signals for Error Output
	Chap. A 5.3.14.4	ERRORLIMITSIGNALn	Set Signal to be Evaluated
	Chap. A 5.3.14.5	ERRORLIMITCOMPARETOOn	Set Limit Values
	Chap. A 5.3.14.6	ERRORLIMITVALUESn	Set Value
	Chap. A 5.3.14.7	ERRORLEVELOUTn	Switching Behavior of Switching Outputs
	Chap. A 5.3.14.8	ERRORHYSTERESIS	Switching Hysteresis of Switching Outputs
Analog Output			
	Chap. A 5.3.15.1	ANALOGOUT	Data Selection for Analog Output
	Chap. A 5.3.15.2	META_ANALOGOUT	List of Possible Signals for Analog Output
	Chap. A 5.3.15.3	ANALOGRANGE	Set Current/Voltage Range of Digital-to-Analog Converter (DAC)
	Chap. A 5.3.15.4	ANALOGSCALEMODE	Set Scaling for DAC
	Chap. A 5.3.15.5	ANALOGSCALERANGE	Set Scaling Range
System Settings for Key Functions			
	Chap. A 5.3.16.1	KEYLOCK	Selection of the Key Lock
	Chap. A 5.3.16.2	BOOTMODE	Switch EtherCAT to Ethernet Setup Mode

A 5.3 General Commands

A 5.3.1 General

A 5.3.1.1 Help

```
HELP [<Command>]
```

Output help for each command. If no command is given, a general help is output.

A 5.3.1.2 Controller Information

```
GETINFO
```

Request sensor information. Output see example below:

```
->GETINFO
Name:          IFD2415-3/IE
Serial:        12345678
Option:        000
Article:       1234567
MAC address:   00-0C-12-01-E2-0C
Version:       004,004
Hardware-rev: 01
Boot version:  001,018
BuildID:       57
Output variant: IE setup
->
```

Name: Model name of controller / controller series

Serial: Controller serial number

Option: Controller option number

Article: Controller article number

MAC address: Address of network adapter

Version: Version of software booted

Hardware-rev: Hardware revision used

Boot version: Bootloader version

BuildID: Identification number for software generated

Command is mapped in SDOs 0x3005, 0x1008, 0x1009 and 0x100A.

A 5.3.1.3 Reply type

```
ECHO ON | OFF
```

The reply type describes the structure of a command reply.

ECHO ON: The command name and the command reply or an error message is output.

ECHO OFF: The command name and the command reply or an error message is output.

A 5.3.1.4 Parameter Overview

```
PRINT ALL
```

no parameters: This command outputs a list of all configuration parameters and their values.

- ALL : This command outputs a list of all configuration parameters and their values, such as sensor table or GETINFO, from

A 5.3.1.5 Synchronization

SYNC NONE | MASTER | SLAVE_SYNTRIG | SLAVE_TRIGIN

Set synchronization type:

- NONE: No synchronization
- MASTER: Controller is master, i.e., it outputs synchronization pulses at the Sync/Trig output
- SLAVE_SYNTRIG: Controller is slave and waits for synchronization pulses, e.g., from another IFC2421/2422/2465/2466 or similar pulse source, at the Sync/Trig input.
- SLAVE_TRIGIN: Controller is slave and waits for synchronization pulses from a frequency generator at the TrigIn input.

Input	Behavior
Sync/Trig	Differential
TrigIn	TTL / HTL

Sync/Trig is alternatively an input or an output, i.e. it must be ensured that one of the controllers is always switched to master and the other to slave.

The TrigIn input also serves as a trigger input for the trigger types edge and level triggering.

Command is mapped in the SDO 0x35B1.

A 5.3.1.6 Termination Resistor at Sync/Trig

TERMINATION OFF | ON

The termination resistor 120 Ohm at the Sync/Trig synchronization input is switched on or off.

Command is mapped in the SDO 0x35B1.

A 5.3.1.7 Boot Sensor

RESET

The controller is restarted.

Command is mapped in the SDO 0x3101.

A 5.3.1.8 Reset Counter

RESETCNT [TIMESTAMP] [MEASCNT]

The counter is reset after the selected trigger edge occurs.

- TIMESTAMP: resets the timestamp
- MEASCNT: resets the measured value counter

Command is mapped in the SDO 0x3107.

A 5.3.2 User level

A 5.3.2.1 Change User Level

```
LOGIN <Password>
```

Enter the password to access another user level. There are the following user levels:

- USER: Read access to all elements + use of web diagrams
- PROFESSIONAL: Read/write access to all elements

Command is mapped in the SDO 0x3001.

A 5.3.2.2 Switch to User Level

```
LOGOUT
```

Set user level to USER.

Command is mapped in the SDO 0x3001.

A 5.3.2.3 User Level Query

```
GETUSERLEVEL
```

Queries the current user level.

Possible outputs, see [Chap. A 5.3.2.1](#), “Change User Level”.

A 5.3.2.4 Set Standard User

```
STDUSER USER|PROFESSIONAL
```

Sets the standard user who is logged in after the system starts.

A 5.3.2.5 Change Password

```
ASSWD <Old password> <New password> <New password>
```

Change the password for the PROFESSIONAL user. The factory standard password is “000”.

For this, the old password must be entered and the new password must be entered twice. If the new passwords do not match, an error message will be output. The password function is case-sensitive. A password may only contain the letters A to Z and numbers without umlauts/special characters. The maximum length is limited to 31 characters.

A 5.3.3 Level of Multifunction Inputs

```
MFILELEVEL HTL | TTL
```

Selection of input level of the multifunction inputs. (MFI).

- HTL: HTL level
- TTL: TTL level

A 5.3.4 Sensor

A 5.3.4.1 Information on Calibration Tables

SENSORTABLE

```
->SENSOR TABLE
Position      Sensor name,      Measurement range,  Serial number
0,            IFS2404-3,        3.000mm,           05110005
1,            IFS2404-6,        6.000mm,           05120003
2,            IFS2404-2,        2.000mm,           00001335
->
```

Output of all available (taught-in) sensors.

The SENSORTABLE command is valid for the IFD2411.

Command is mapped in the SDO 0x3152.

A 5.3.4.2 Sensor Information

SENSORINFO

Output of information about the sensor (name, measuring range and serial number).

```
->SENSORINFO
Position:      0
Name:          BG
Measurement range: 3,000 mm
Serial:        12345678
->
```

A 5.3.4.3 Dark Correction

DARKCORR

Performing the dark referencing for the current sensor. The dark referencing depends on the sensor and is saved separately for each individual sensor in the controller.

Command is mapped in the SDO 0x3011.

DARKCORR_PRINT

Lists the values of the dark correction table.

A 5.3.4.4 LED

LED OFF | ON

Switches the LED of the respective channel on or off.

A 5.3.4.5 Control Input Measurement Light Source

LEDSOURCE [SOFTWAREONLY | MFI1 | MFI2]

- SOFTWAREONLY: The measurement light source can only be controlled by software; via ASCII command LED ON/OFF or web interface
- MFI1: Control of the measurement light source via selected multifunction input MFI1
- MFI2: Control of the measurement light source via selected multifunction input MFI2

Command is mapped in the SDO 0x3133.

A 5.3.5 Triggering

A 5.3.5.1 Select Trigger Source

TRIGGERSOURCE NONE | SYNCTRIG | TRIGIN | SOFTWARE | ENCODER1 | ENCODER2

- NONE: No trigger source used
- SYNCTRIG: Use input Sync/Trig
- TRIGIN: Use the input TrigIn
- SOFTWARE: Triggering is initiated by the command TRIGGERSW.
- ENCODER1: Encoder triggering of encoder 1
- ENCODER2: Encoder triggering of encoder 2

Command is mapped in the SDO 0x35B0.

A 5.3.5.2 Output of Triggered Values, with/without Averaging

TRIGGERAT INPUT | OUTPUT

- INPUT: Triggers measured value acquisition. Values measured immediately before the trigger event are not included in the average value calculation, but older measured values that were output during previous trigger events are included instead.
- OUTPUT: Triggers measured value output. Values measured immediately before the trigger event are included in the average value calculation.

Triggering of data recording is active as a factory setting.

Command is mapped in the SDO 0x35B0.

A 5.3.5.3 Trigger Type

TRIGGERMODE EDGE | PULSE

Selection of trigger type.

- PULSE: Level triggering
- EDGE: Edge triggering

Command is mapped in the SDO 0x35B0.

A 5.3.5.4 Active Level of Trigger Input

TRIGGERLEVEL HIGH | LOW

- HIGH: Edge triggering: Rising edge, level triggering: High active
- LOW: Edge triggering: Falling edge, level triggering: Low active

Command is mapped in the SDO 0x35B0.

A 5.3.5.5 Software Trigger Pulse

TRIGGERSW

Generates a software trigger pulse when the trigger source is set to software.

Command is mapped in the SDO 0x35B0.

A 5.3.5.6 Number of Measured Values to be Output

TRIGGERCOUNT NONE | INFINITE | <n>

- NONE: Stop triggering
- <n>: Number of measured values to be output after a trigger pulse (with edge triggering or software triggering)
- Infinite: Start of an infinite measured value output after a trigger pulse (with edge triggering or software triggering)

Command is mapped in the SDO 0x35B0.

A 5.3.5.7 Level Section Trigger Input Trigin

TRIGINLEVEL TTL | HTL

The level selection only applies to the input `TrigIn`. The input `Sync/Trig` waits for a differential signal.

- TTL: Input waits for TTL signal.
- HTL: Input waits for HTL signal.

Command is mapped in the SDO 0x35B0.

A 5.3.5.8 Step Size Encoder Triggering

TRIGGERENCSTEPsize [value of step size]

Sets the number of encoder steps after which a measured value is output each time (min: 0, max: $2^{31}-1$). At 0, measured values are continuously output between min and max.

Command is mapped in the SDO 0x35B0.

A 5.3.5.9 Minimum Encoder Triggering

TRIGGERENCMIN [minimum value]

Sets the minimum encoder value starting at which triggering takes place (min: 0 max: $2^{32}-1$).

Command is mapped in the SDO 0x35B0.

A 5.3.5.10 Maximum Encoder Triggering

TRIGGERENCmax [maximum value]

Sets the maximum encoder value up to which triggering takes place (min: 0 max: $2^{32}-1$).

Command is mapped in the SDO 0x35B0.

A 5.3.6 Encoder

A 5.3.6.1 Number of Available Encoders

META_ENCODERCOUNT

Lists the number of available encoders that can be selected with `ENCODERCOUNT`.

A 5.3.6.2 Encoder Interpolation Depth

ENCINTERPOL1 1 | 2 | 3

ENCINTERPOL2 1 | 2 | 3

ENCINTERPOL3 1 | 2 | 3

Sets the interpolation depth of the respective encoder input.

- 1 - Single interpolation
- 2 - Dual interpolation
- 3 - Quadruple interpolation

Command is mapped in the SDO 0x35A0.

A 5.3.6.3 Effect of Reference Track

ENCREF1 NONE | ONE | EVER

ENCREF2 NONE | ONE | EVER

Sets the effect of the encoder reference track.

- NONE: Encoder reference marker has no effect.
- ONE: One-time setting (the first time the reference marker is reached, the encoder value, see [Chap. A 5.3.6.4](#) will be adopted).
- EVER: Setting for all markers (every time the reference marker is reached, the encoder value, see [Chap. A 5.3.6.4](#) will be adopted).

Command is mapped in the SDO 0x35A0.

A 5.3.6.4 Encoder value

```
ENCVALUE1 <encoder value>
```

```
ENCVALUE2 <encoder value>
```

```
ENCVALUE3 <encoder value>
```

Indicates the value which the corresponding encoder should be set to when a reference marker is reached (or via software).

The encoder value can be between 0 and $2^{32}-1$.

Setting the ENCVALUE automatically resets the algorithm for recognizing the first reference marker, see [Chap. A 5.3.6.3](#).

Command is mapped in the SDO 0x35A0.

A 5.3.6.5 Set Encoder Value via Software

```
ENCSET 1 | 2 | 3
```

Set the encoder value, see [Chap. A 5.3.6.4](#), in the specified encoder via software (only possible with ENCREF NONE, otherwise the command immediately returns without an error message).

Command is mapped in the SDO 0x35A0.

A 5.3.6.6 Reset Detection of First Reference Marker

```
ENCRESET 1 | 2
```

Resets the detection of the first reference marker, see [Chap. A 5.3.6.3](#) (only possible with ENCREF ONE, otherwise the command immediately returns without an error message).

Command is mapped in the SDO 0x35A0.

A 5.3.6.7 Maximum Encoder Value

```
ENCMAX1 <encoder value>
```

```
ENCMAX2 <encoder value>
```

```
ENCMAX3 <encoder value>
```

Indicates the maximum value of the encoder after which the encoder jumps back to 0. Can be used for rotary encoders without reference track.

The encoder value can be between 0 and $2^{32}-1$.

Command is mapped in the SDO 0x35A0.

A 5.3.6.8 Number of Active Encoders

```
ENCODERCOUNT 1 | 2 | 3
```

- 1: Encoder 1 is active, encoders 2 and 3 are inactive
- 2: Encoders 1 and 2 are active, encoder 3 is inactive
- 3: Encoder 1 to 3 are active

Command is valid with the IFD2410/2415.

Command is mapped in the SDO 0x35A0.

A 5.3.7 Setting the RS422 Baud Rate

BAUDRATE <Baudrate>

Baud rates can be set in Bps for the RS422 interface:

9600, 115200, 230400, 460800, 691200, 921600, 2000000, 3000000, 4000000

Command is mapped in the SDO 0x31B0.

A 5.3.8 Parameter Management, Load/Save Settings

A 5.3.8.1 Load / Save Connection Settings

```
BASICSETTINGS READ | STORE
```

- READ: Reads the connection settings from the controller flash.
- STORE: Saves the current connection settings from the controller RAM to the controller flash.

Command is mapped in the SDO 0x3020.

A 5.3.8.2 Show Changed Parameters

```
CHANGESETTINGS
```

Outputs all changed settings.

A 5.3.8.3 Export Parameter Sets to PC

```
EXPORT (MEASSETTINGS <SetupName>) | BASICSETTINGS | MEASSETTINGS_ALL | MATERIALTABLE | ALL
```

Saves parameters in an external device, e.g. PC.

The export file is formatted as readable JavaScript Object Notation, or JSON for short.

- MEASSETTINGS <SetupName>: Exports the specified measurement settings. Nothing is deleted before importing.
- BASICSETTINGS: Export the currently saved basic settings. The basic settings are deleted before importing.
- MEASSETTINGS_ALL: Export all saved measurement settings, including the initial setting. All existing measurement settings are deleted before importing.
- MATERIALTABLE: Exports the saved material table. The existing material table is deleted before importing.
- ALL: Complete export of all saved settings (Basic and Meas), the material table and all sensor data saved. Everything is deleted before importing.

A 5.3.8.4 Import Parameter Sets from PC

```
IMPORT [FORCE] [APPLY] <Data>
```

Loads parameters from an external device, e.g. PC.

The import file is a JSON file previously saved with export.

- FORCE: Overwrite measurement settings with the same name, otherwise an error message is returned if the names are the same. If all measurement settings or basic settings are imported, Force must always be specified.
- APPLY : Apply the settings after importing and reading the initial settings.

A 5.3.8.5 Factory Settings

```
SETDEFAULT ALL | MEASSETTINGS | BASICSETTINGS | MATERIAL
```

Set the default values (reset to factory settings), delete the corresponding settings in the flash.

- ALL: All setups are deleted and the default parameters are loaded. The current material table is also overwritten by the standard material table.
- MEASSETTINGS: Settings for measurement task.
- BASICSETTINGS: Basic settings such as IP, baud rate, language, unit.
- MATERIAL: Only overwrite the current material table with the standard material table.

Command is mapped in the SDOs 0x3020, 0x3022, 0x3105 and 0x3802.

A 5.3.8.6 Editing, Storing, Displaying, Deleting Measurement Settings

MEASSETTINGS <Subcommand> [<Name>]

Settings for measurement task. Moves application-dependent measurement settings between controller RAM and controller flash. Either the manufacturer-specific presets or the user-defined settings are used. Each preset can be used as a user-defined setting.

Subcommands:

PRESETMODE <mode>	Defines the preset dynamics.
<mode> = NONE STATIC BALANCED DYNAMIC	With NONE, there is no selection for a preset.
PRESETLIST	Lists all existing presets (names): "Name1" "Name2" "..."
READ <Name>	Loads a basic setting or measurement setting/preset (specify name) from the controller flash.
STORE <Name>	Saves a basic setting or measurement setting in the controller flash. Enter name or it will be saved under the current name.
DELETE <Name>	Deletes the named measurement setting from the controller flash.
RENAME <NameOld> <NameNew> [FORCE]	Changes the name of a measurement setting in the controller flash. An existing measurement setting can be overwritten with FORCE.
LIST	Lists all saved measurement settings (names) "Name1" "Name2" "...". The order is based on the internal slot numbers, that is, not the order of saving.
CURRENT	Outputs the current measurement setting / preset (name)
INITIAL AUTO	Loads the last saved setting when the controller is started or the first preset if no setups are present.
INITIAL <Name>	Loads a named measurement setting upon starting the controller. Presets cannot be entered.

Command is mapped in the SDOs 0x3021 and 0x3022.

A 5.3.9 Measurement

A 5.3.9.1 Peak count

PEAKCOUNT <n>

Indicates the maximum number of peaks to be evaluated.

- For distance measurement <n> = 1
- For thickness measurement <n> = 2
- For multi-layer measurement <n> >2

Command is mapped in the SDO 0x3156.

A 5.3.9.2 Peak Selection

MEASPEAK F_L|L_SL|F_S|H_SH

Selection of the peaks used for the measurement

Distance measurement		Thickness measurements	
F_L:	first peak	F_L:	first and last peak
L_SL:	last peak	L_SL:	second-last and last peak
F_S:	first peak	F_S:	first and second peak
H_SH:	highest peak	H_SH:	highest and second highest

Command is mapped in the SDO 0x3161.

A 5.3.9.3 Number of Peaks and Switching Refractivity Correction On/Off

REFRACCORR on | off

- On: The refractivity correction is carried out with the set materials, standard setting.
- Off: The refractivity index 1.0 is assumed for all layers.

Command is mapped in the SDO 0x3156.

A 5.3.9.4 Exposure Mode

SHUTTERMODE MEAS|MANUAL|2TIMEALT|2TIMES

- MEAS: Automatic exposure time control with fixed measuring rate, recommended for measurement
- MANUAL: Selectable exposure time and measuring rate.
- 2TIMEALT: Mode with 2 manually set exposure times which are always applied alternately, for 2 peaks of very different height in the thickness measurement. We recommend using this mode in particular if the smaller peak disappears or the larger one is overmodulated.
- 2TIMES: Fastest mode with two manually preset exposure times. The more suitable time is automatically selected. Recommend for distance measurement for rapidly changing surface properties, such as mirrored or anti-glare glass.

Command is mapped in the SDO 0x3250.

A 5.3.9.5 Measuring rate

MEASRATE <measuring rate>

Enter the measuring rate in kHz:

IFC2421/2422: Value range 0.100 ... 6.500;

IFC2465/2466: Value range 0.100 ... 30.000.

A maximum of three decimal places can be specified, e.g. 0.100 for 0.1 kHz.

Command is mapped in the SDO 0x3156.

A 5.3.9.6 Exposure Time

SHUTTER <exposure time1> [<exposure time2>]

Indication of exposure times for manual and two-time exposure modes.

The exposure time is processed with three decimal places. The minimum step size is 0.1 μ s.

Command is mapped in the SDO 0x3250.

A 5.3.9.7 Range of Interest (ROI)

ROI <Start> <End>

Sets the range of interest for the respective channel. Start and end must be between 0 and 511. The entry is made in the unit pixels. The start value must be less than the end value.

Command is mapped in the SDO 0x3711.

A 5.3.9.8 Minimum Threshold Peak Detection

MIN_THRESHOLD <n>

Sets the minimum detection threshold. A peak must be above this threshold for it to be recognized as peak.

The entry is made in % and relates to the dark corrected signal.

Command is mapped in the SDO 0x3162.

A 5.3.9.9 Peak Modulation

```
PEAK_MODULATION <n>
```

Specifies the peak modulation through so that peaks running into each other are separated. At 100%, there is no peak separation and at 0% (factory setting), all peaks are separated.

This way, the relevant peak artefacts can be removed or not be considered as individual peaks.

Command is mapped in the SDO 0x3162.

A 5.3.10 Material Database

A 5.3.10.1 Material Table

```
MATERIALTABLE
```

Output of the material table saved in the controller.

```
->MATERIALTABLE
```

Item	Name	Refraction index			Abbe number vd	Description
		nF at 486nm	nd at 587nm	nC at 656nm		
0	Vacuum	1.000000	1.000000	1.000000	0.000000	Vacuum; air (approximate)
1	Water	1.337121	1.333044	1.331152	0.000000	
1	Ethanol	1.361400	1.361400	1.361400	0.000000	
7	PC	1.599439	1.585470	1.579864	0.000000	Polycarbonate
8	Quartz glass	1.463126	1.458464	1.456367	0.000000	Silicon dioxide, fused silica
9	BK7	1.522380	1.516800	1.514320	0.000000	Crown glass

```
->
```

A 5.3.10.2 Select Material

```
MATERIAL <Materialname>
```

Change the material between distance 1 and 2 for the respective channel.

The material name must be entered, including spaces. The command supports case sensitive input, distinguishing between uppercase and lowercase letters. The maximum length of the material name is 30 characters.

Command is mapped in SDOs 0x3802 and 0x3804.

A 5.3.10.3 Show Material Property

```
MATERIALINFO
```

Output of the material properties of the selected layer. Layer 1 is between distance 1 and 2, Layer 2 between distance 2 and 3, etc. If there are no parameters, the information on layer 1 is output.

Example:

```
->MATERIALINFO
Name:                BK7
Description:         Crown glass
Refraction index nF at 486nm: 1.522380
Refraction index nd at 587nm: 1.516800
Refraction index nC at 656nm: 1.514320
Abbe value vd:       0.000000
->
```

Command is mapped in the SDO 0x3800.

A 5.3.10.4 Existing Material in Controller

```
META_MATERIAL
```

Lists the material names already saved in the controller.

A 5.3.10.5 Protected Materials in Controller

```
META_MATERIAL_PROTECTED
```

Displays a list of all material names saved in the controller during calibration. These materials cannot be edited or deleted.

Displays a list of all material names saved in the controller during calibration. These materials cannot be edited or deleted.

A 5.3.10.6 Edit Material Table

```
MATERIALEDIT <Name> <Description> (NX <nF> <nd> <nC>)|(ABBE <nd> <vd>)
```

Edits an existing material. A material is characterized either by three refractive indices or by one refractive index and Abbe number.

- Name: Name of the material
- Description: Brief description of the material
- nF: Refractivity index nF at 670 nm (1.000000 ... 4.000000)
- nd: Refractivity index nd at 587 nm (1.000000 ... 4.000000)
- nC: Refractivity index nC at 656 nm (1.000000 ... 4.000000)
- vd: Abbe value (10.000000 ... 100.000000)

If the material name has already been assigned, this material will be edited. Otherwise, a new material will be created.

There is a maximum of 20 materials.

A 5.3.10.7 Delete a Material

```
MATERIALDELETE <Name>
```

Deletes a material.

- Name: Name of the material (length: max. 30 characters)

Command is mapped in the SDO 0x3802.

A 5.3.10.8 Add Material

```
MATERIALADD <Name> <Description> (NX <nF> <nd> <nC>)|(ABBE <nd> <vd>)
```

Adds a material to the material table. A material is characterized either by three refractive indices or by one refractive index and Abbe number.

- Name: Name of the material
- Description: Brief description of the material
- nF: Refractivity index nF at 670 nm (1.000000 ... 4.000000)
- nd: Refractivity index nd at 587 nm (1.000000 ... 4.000000)
- nC: Refractivity index nC at 656 nm (1.000000 ... 4.000000)
- vd: Abbe value (10.000000 ... 100.000000)

A 5.3.11 Edit measured value

A 5.3.11.1 Statistical Calculations

```
STATISTIC <signal> RESET
```

Resets individual statistics.

- <signal>: Statistical data Minimum, Maximum or Peak-Peak

Command is mapped in SDOs 0x3A10, 0x3A11 and 0x3A12.

A 5.3.11.2 List of Statistics Signals

```
META_STATISTIC
```

Provides a list of the active statistics signals.

These signals were defined under STATISTICSIGNAL.

A 5.3.11.3 Selection of Statistics Signal

```
STATISTICSIGNAL <signal>
```

The statistics are created for the selected signal. A list of possible signals can be found by using the command `META_STATISTICSIGNAL`.

New signals will be created, which can then be output via the interfaces.

- `<signal>_MIN` --> Minimum signal
- `<signal>_MAX` --> Maximum signal
- `<signal>_PEAK` --> `<signal>_max` - `<signal>_min`

Command is mapped in SDOs 0x3A10, 0x3A11 and 0x3A12.

A 5.3.11.4 List of Possible Statistics Signals to Select

```
META_STATISTICSIGNAL
```

Lists all possible signals that can be included in the statistics.

Command is mapped in SDOs 0x3A10, 0x3A11 and 0x3A12.

A 5.3.11.5 List of Possible Signals to be Parameterized

```
META_MASTERSIGNAL
```

Lists all possible signals that can be used for mastering.

Command is mapped in SDOs 0x3A00, 0x3A01 ... 0x3A09.

A 5.3.11.6 Parameterization of Master Signals

```
MASTERSIGNAL [<signal>]
```

```
MASTERSIGNAL <signal> <master value>
```

```
MASTERSIGNAL <signal> NONE
```

Defines the signal to be mastered. The parameter `NONE` resets the signal. The function itself is triggered with `MASTER`.

- `<signal>`: select a specific measured or calculated signal which the master value is to be set to; see `META_MASTER-SIGNAL`
- `<master value>` master value in mm, value range: -2147.0 ... 2147.0

Command is mapped in SDOs 0x3A00, 0x3A01 ... 0x3A09.

A 5.3.11.7 List of Possible Signals for Mastering

```
META_MASTER
```

Lists all defined master signals from the `MASTERSIGNAL` command. These can be used with the command `MASTER`.

A 5.3.11.8 Mastering / Zeroing

```
MASTER [<signal>]
```

```
MASTER [ALL|<signal> [SET|RESET]]
```

The `MASTER` command is not channel-specific. There are up to 10 master signals in the controller. These 10 signals can be applied to any internally determined value, including calculated values.

This command sets or resets the mastering for the corresponding signal.

- `ALL`: use all signals for mastering
- `<signal>`: use a specific measured or calculated signal for mastering
- `SET|RESET`: Start or end function

If the master value is 0, the mastering function has the same functionality as zeroing.

The master command waits a maximum of 2 seconds for the next measured value and uses this as the master value. If no measured value was recorded within this time, in case of external triggering, for example, the command returns with the error "E32 Timeout". The master value is processed with six decimal places.

Command is mapped in SDOs 0x3A00, 0x3A01 ... 0x3A09.

A 5.3.11.9 Signal for Mastering with External Source

Select the measured or calculated signal that can be mastered with the multifunction inputs or with an external source. META_MASTER provides a list of all defined master signals. The signals are configured using MASTERSIGNAL.

```
MASTERSIGNALSELECT [ALL | NONE | <signal1> [ | <signal2> [...]]]
```

- ALL: All configured signals are mastered with the selected input source.
- NONE: no mastering.
- signal: Signal is mastered with external source

A 5.3.11.10 Mastering with External Source

```
MASTERSOURCE [NONE|MFI1|MFI2]
```

Select the input with which a mastering/zeroing is to be triggered.

- NONE: No port selected. (Controlling by commands is possible.)
- MFI1: Use MFI1-port to control the mastering function.
- MFI2: Use MFI2-port to control the mastering function.

Command is mapped in the SDO 0x39FF.

A 5.3.11.11 Example of Mastering

For the example, the preset option Standard matt "Opposite thickness measurement" was selected in the controller; execution of the commands with the Telnet program, no variables are defined.

->o 169.254.168.150					
->META_MASTERSIGNAL META_MASTERSIGNAL 01DIST1 01DIST1 FOIL	// List all variables that can be mastered to				
->META_MASTER META_MASTER NONE	// List all variables that have been assigned a master value				
->MASTERSIGNAL 01DIST1 1.0 ->MASTERSIGNAL FOIL 2.1	// Set variable 01DIST1 to the value 1.0 // Set variable FOIL to the value 2.1				
->META_MASTER META_MASTER 01DIST1 FOIL	// List all variables that have been assigned a master value; the variable 01DIST1 has now been assigned				
->MASTER ALL MASTER 01DIST1 INACTIVE MASTER FOIL INACTIVE MASTER NONE ... MASTER NONE MASTER NONE	// List all 10 possible variables and show their status				
	<table border="1"> <tr> <td>01DIST1 0.89077 mm</td> <td>01DIST2 2.12215 mm</td> <td>Foil 1.23137 mm</td> <td>Measuring rate 1.800 kHz</td> </tr> </table>	01DIST1 0.89077 mm	01DIST2 2.12215 mm	Foil 1.23137 mm	Measuring rate 1.800 kHz
01DIST1 0.89077 mm	01DIST2 2.12215 mm	Foil 1.23137 mm	Measuring rate 1.800 kHz		
->MASTER ALL SET	// Triggers a master measurement for all assigned variables				
	<table border="1"> <tr> <td>01DIST1 1.00314 mm</td> <td>01DIST2 2.12511 mm</td> <td>Foil 2.10092 mm</td> <td>Measuring rate 1.800 kHz</td> </tr> </table>	01DIST1 1.00314 mm	01DIST2 2.12511 mm	Foil 2.10092 mm	Measuring rate 1.800 kHz
01DIST1 1.00314 mm	01DIST2 2.12511 mm	Foil 2.10092 mm	Measuring rate 1.800 kHz		
->MASTER 01DIST1 RESET	// the offset (master value) is undone for the variable 01DIST1				
	<table border="1"> <tr> <td>01DIST1 0.89105 mm</td> <td>01DIST2 2.12485 mm</td> <td>Foil 2.10154 mm</td> <td>Measuring rate 1.800 kHz</td> </tr> </table>	01DIST1 0.89105 mm	01DIST2 2.12485 mm	Foil 2.10154 mm	Measuring rate 1.800 kHz
01DIST1 0.89105 mm	01DIST2 2.12485 mm	Foil 2.10154 mm	Measuring rate 1.800 kHz		

<p>->MASTER ALL MASTER 01DIST1 INACTIVE MASTER FOIL ACTIVE MASTER NONE ... MASTER NONE MASTER NONE</p>									
<p>->MASTER FOIL RESET</p>	<p>// the offset (master value) is undone for the variable FOIL</p> <table border="1" data-bbox="710 510 1465 586"><tr><td data-bbox="710 510 885 548">01DIST1</td><td data-bbox="901 510 1077 548">01DIST2</td><td data-bbox="1093 510 1268 548">Foil</td><td data-bbox="1284 510 1465 548">Measuring rate</td></tr><tr><td data-bbox="710 548 885 586">0.89087 mm</td><td data-bbox="901 548 1077 586">2.12048 mm</td><td data-bbox="1093 548 1268 586">1.23745 mm</td><td data-bbox="1284 548 1465 586">1.800 kHz</td></tr></table>	01DIST1	01DIST2	Foil	Measuring rate	0.89087 mm	2.12048 mm	1.23745 mm	1.800 kHz
01DIST1	01DIST2	Foil	Measuring rate						
0.89087 mm	2.12048 mm	1.23745 mm	1.800 kHz						
<p>->MASTERSIGNAL 01DIST1 NONE ->MASTERSIGNAL FOIL NONE</p>	<p>// The variable 01DIST1 is deleted // The variable FOIL is deleted</p>								
<p>->MASTER ALL MASTER NONE ... MASTER NONE</p>	<p>// no variable which a master measurement could be applied to is present</p>								

A 5.3.11.12 Calculation in channel

```

COMP [<channel> [<id>]]
COMP <channel> <id> MEDIAN <signal> <median data count>
COMP <channel> <id> MOVING <signal> <moving data count>
COMP <channel> <id> RECURSIVE <signal> <recursive data count>
COMP <channel> <id> CALC <factor1> <signal> <factor2> <signal> <offset> <name>
COMP <channel> <id> THICKNESS <signal> <signal> <name>
COMP <channel> <id> COPY <signal> <name>
COMP <channel> <id> NONE

```

This command defines all channel-specific as well as controller-specific calculations.

- <channel> CH01|CH02|SYS *Channel selection*
- <id> 1...10 *Calculation block number*
- <signal> *Measuring signal; you can query the available signals with the command META_COMP*
- <median data count> 3|5|7|9 *Averaging depth median*
- <moving data count> 2|4|8|16|32|64|128|256|512|1024|2048|4096 *Averaging depth moving average*
- <recursive data count> 2 ... 32000 *Averaging depth recursive average*
- <factor1>, <factor2> -32768.0 ... 32767.0 *Multiplication factor*
- <offset> -2147.0 ... 2147.0 *Correction value in mm*
- <name> *Name of calculation block; length min. 2 characters, max. 15 characters. Permitted characters a-zA-Z0-9, the name must start with a letter. Command names such as STATISTIC, MASTER, CALC, NONE, ALL are not permitted.*

You can use the COMP command to create new calculation blocks, modify or delete calculation blocks.

Functions:

- MEDIAN, MOVING and RECURSIVE: Averaging functions
- CALC: Calculation function according to formula
(<factor1> * <signal>) + (<factor2> * <signal>) + <offset>
- Thickness: Thickness calculation according to the formula <signal B> - <signal A> under the condition that signal B is larger than signal A
- COPY: Duplicates a signal; the effect can also be achieved with the command CALC, e.g. with (1 * <signal>) + (0 * <signal>) + 0
- NONE: deletes a calculation block

Command is mapped in SDOs 0x3C00, 0x3C01 ... 0x3C09.

A 5.3.11.13 List of Possible Calculation Signals

```
META_COMP
```

Lists all possible signals that can be used in the calculation.

Command is mapped in SDOs 0x3C00, 0x3C01 ... 0x3C09.

A 5.3.11.14 Two-Point Scaling Data Outputs

```
SYSSIGNALRANGE <start of range> <end of range>
```

The values determined from the calculation can be greater than the values that the controller can display. The range of values is determined with this command.

Default is 0 to 10 mm

Command is mapped in the SDO 0x3CBF.

A 5.3.12 Data Output

A 5.3.12.1 Digital Output Selection

```
OUTPUT [NONE|([RS422 | IE] [ANALOG] [ERROROUT])]
```

- NONE: No output of measured values
- RS422: Output of measured values via RS422
- IE: Output of measured values via Industrial Ethernet, not parallel with RS422¹.
- ANALOG: Output of measured values via analog output
- ERROROUT: Error or status information via the error outputs

Command starts the output of measured values. The connection to the measured value server can already exist or can now be established.

A 5.3.12.2 Output Data Rate

```
OUTREDUCEDEVICE [NONE|([RS422] | [ANALOG])]
```

Reduction of output of measured values via specified interfaces.

- NONE: No reduction of output of measured values
- RS422: Reduction of output of measured values via RS422
- ANALOG: Reduction of output of measured values via analog interface

A 5.3.12.3 Reduction Counter for Output of measured values

```
OUTREDUCECOUNT <count>
```

Reduction counter for output of measured values.

Only each nth measured value is output. The other measured values are rejected.

- Number: 1...3000000 (1 means all frames)

Command is mapped in the SDO 0x31B3.

A 5.3.12.4 Error Handling

```
OUTHOLD NONE|INFINITE|<count>
```

Sets the measured value output behavior in the event of an error.

- NONE: Last measured value not held; error value output
- INFINITE: Last measured value held indefinitely
- Number: Holds the last measured value via measurement cycle count and then outputs the error value (maximum 1024)

Command is mapped in the SDO 0x31B2.

1) The controller issues an error if IE and RS422 are selected in parallel. IE is implicitly activated when the EtherCAT state machine starts up or during PDO mapping; if RS422 was previously active, it is implicitly removed.

A 5.3.13 Selection of Measured Values to be Output

A 5.3.13.1 General

Setting the values to be output via the RS422 interface.

A limitation of the data volume via the RS422 depends on the measuring frequency and the baud rate.

In multi-layer measurement mode, any desired distances and differences can be selected for output.

A 5.3.13.2 Data Selection for RS422

```
OUT_RS422
```

Describes which data is output via this interface.

A 5.3.13.3 List of Possible Signals for RS422

```
META_OUT_RS422
```

List of possible data for the RS422.

Command is mapped in the SDO 0x31F5.

A 5.3.13.4 List of Selected Signals, Sequence via Rs422

```
GETOUTINFO_RS422
```

Returns the order of the signals via this interface.

Command is mapped in the SDO 0x31F5.

A 5.3.14 Switching Outputs

A 5.3.14.1 General

Commands are valid for the IFD2410/2415.

A 5.3.14.2 Error - Switching Outputs

```
ERROROUT1 [01ER1|01ER2|01ER12|ERRORLIMIT]
```

```
ERROROUT2 [01ER1|01ER2|01ER12|ERRORLIMIT]
```

Setting the error switching outputs.

- 01ER1: Switching output is switched in the event of an intensity error
- 01ER2: Switching output is switched in the event of a measuring range error
- 01ER12: Switching output is switched in the event of an intensity error or a measuring range error
- ERRORLIMIT: Switching output is switched when the measured value is outside the limit values; the basis is formed by the settings for ERRORLIMITSIGNAL1/2, ERRORLIMITCOMPARETO1/2 and ERRORLIMITVALUES1/2.

A 5.3.14.3 List of Possible Signals for Error Output

```
META_ERRORLIMITSIGNAL1
```

```
META_ERRORLIMITSIGNAL2
```

List of all signals that are possible for the ERRORLIMITSIGNALn command.

A 5.3.14.4 Set Signal to be Evaluated

```
ERRORLIMITSIGNAL1 [<signal>]
```

```
ERRORLIMITSIGNAL1 [<signal>]
```

Selection of the signal to be used for the limit value analysis.

A 5.3.14.5 Set Limit Values

```
ERRORLIMITCOMPARETO1 [LOWER | UPPER | BOTH]
```

```
ERRORLIMITCOMPARETO2 [LOWER | UPPER | BOTH]
```

Specifies whether the output should activate upon

- LOWER --> undershot
- UPPER --> exceeded
- BOTH --> undershot or exceeded

A 5.3.14.6 Set Value

```
ERRORLIMITVALUES1 [<lower limit [mm]> <upper limit [mm]>]
```

```
ERRORLIMITVALUES2 [<lower limit [mm]> <upper limit [mm]>]
```

Sets the values for Lower and Upper limit values.

- <lower limit [mm]> = -2147.0 ... 2147.0
- <upper limit [mm]> = -2147.0 ... 2147.0

A 5.3.14.7 Switching Behavior of Error Outputs

```
ERRORLEVELOUT1 [PNP|NPN|PUSHPULL|PUSHPULLNEG]
```

```
ERRORLEVELOUT2 [PNP|NPN|PUSHPULL|PUSHPULLNEG]
```

Switching behavior of error outputs Error 1 and Error 2.

- PNP: Switching output is High in the case of an error and open without error
- NPN: Switching output is Low in the case of an error and open without error
- PUSHPULL: Switching output is High in the case of an error and Low without error
- PUSHPULLNEG: Switching output is Low in the case of an error and High without error

A 5.3.14.8 Switching Hysteresis of Error Outputs

```
ERRORHYSTERESIS1 <hysteresis [mm]>
```

```
ERRORHYSTERESIS2 <hysteresis [mm]>
```

Sets the hysteresis for the switching outputs, see also function ERRORLIMIT.

- <hysteresis [mm]> = (0..2) * measurement range [mm]

A 5.3.15 Analog Output

A 5.3.15.1 Data Selection

```
ANALOGOUT signal
```

Selection of the signal to be output via the analog output. The signal is specified as a parameter. A list with the possible signals can be shown with META_ANALOGOUT, see [Chap. A 5.3.15.2](#).

Command is mapped in the SDO 0x31D0.

A 5.3.15.2 List of Possible Signals for Analog Output

```
META_ANALOGOUT
```

Lists all signals that can be connected to the analog output.

Command is mapped in the SDO 0x31D0.

A 5.3.15.3 Output Range

```
ANALOGRANGE 0-5V | 0-10V | 4-20mA
```

- 0-5 V: The analog output puts out a voltage of 0 to 5 volts.
- 0-10 V: The analog output puts out a voltage of 0 to 10 volts.
- 4-20mA: The analog output puts out a current of 4 to 20 milliamperes.

Command is mapped in the SDO 0x31D0.

A 5.3.15.4 Set Scaling for DAC

```
ANALOGSCALEMODE STANDARD | TWOPOINT
```

Selects whether to use one-point or two-point scaling of the analog output.

- STANDARD --> One-point scaling
- TWOPOINT --> Two-point scaling

The standard scaling is configured for distances -MB/2 to MB/2 and for thickness measurement from 0 to 2 MB (MB=measuring range).

Minimum and maximum measured values must be specified in millimeters. The available output range of the analog output is then spread between the minimum and maximum measured values. The minimum and maximum measured values must be between -2147.0 and 2147.0.

The minimum and maximum measured values are processed with three decimal places.

Command is mapped in the SDO 0x31D0.

A 5.3.15.5 Set Scaling Range

```
ANALOGSCALERANGE <limit 1> <limit 2>
```

Two-point scaling requires the start and end of the range to be entered in millimeters.

- <limit 1> = (-2147.0 ... 2147.0) [mm], and different from <limit 2>.
- <limit 2> = (-2147.0 ... 2147.0) [mm], and different from <limit 1>.

The values cannot be identical.

Command is mapped in the SDO 0x31D0.

A 5.3.16 System Settings

A 5.3.16.1 Key Lock

```
KEYLOCK NONE | ACTIVE | (AUTO [<value>])
```

Selection of the key lock.

- NONE: Key always functions; no key lock
- ACTIVE: Key lock activates immediately upon restart
- AUTO: Key lock is only activated <time> minutes after restart, value range 1 ... 60 min

Command is mapped in the SDO 0x34A0.

A 5.3.16.2 Switch EtherCAT to Ethernet Setup Mode

```
BOOTMODE [FIELDDBUS|RECOVERY]
```

Switches firmware. No action is taken if the requested firmware is already active. Otherwise, the requested firmware is installed and a restart takes place. The switch takes approx. one minute. The power supply for the IFD must not be interrupted during this time.

- FIELDDBUS: Start with EtherCAT
- RECOVERY: Start in Ethernet setup mode

A 5.4 Measured Value Format

A 5.4.1 Structure

The structure of measured value frames depends on the selection of the measured values or on the selection of a preset. In the following overview, you will find a summary of commands which you can use to query the available measured values via RS422.

Chap. A 5.3.13.2	OUT_RS422	Data selection for RS422
Chap. A 5.3.13.3	META_OUT_RS422	List of Possible Signals RS422
Chap. A 5.3.13.4	GETOUTINFO_RS422	List of Selected Signals, Sequence via RS422

Example for the structure of a data block, query via Telnet:

Preset Standard matt ->META_OUT_RS422 META_OUT_RS422 01RAW 01DARK 01LIGHT 01SHUTTER 01ENCODER1 01INTENSITY 01SYMM 01DIST1 MEAS- RATE TRIGTIMEDIFF TIMESTAMP TIMESTAMP_HIGH TIMESTAMP_LOW COUNTER 01DIST1_MIN 01DIST1_PEAK 01DIST1_MAX ->	Preset Multisurface ->META_OUT_RS422 META_OUT_RS422 01RAW 01DARK 01LIGHT 01SHUTTER 01ENCODER1 01INTENSITY 01SYMM 01DIST1 01DIST2 01DIST3 MEASRATE TRIGTIMEDIFF TIMESTAMP TIMESTAMP_HIGH TIMESTAMP_LOW COUNTER Ch01Thick12 Ch01Thick23 ->
->GETOUTINFO_RS422 GETOUTINFO_RS422 01SHUTTER 01IN- TENSITY1 01DIST1 ->	->GETOUTINFO_RS422 GETOUTINFO_RS422 01SHUTTER 01INTENSITY1 01DIST1 01INTENSITY2 01DIST2 01INTENSITY3 01DIST3 Ch01Thick12 Ch01Thick23 ->

A measured value frame is built dynamically, i.e., values not selected are not transmitted.

A 5.4.2 Video Signal

The video signals that have been calculated in the signal processing process can be transmitted. A video signal comprises 512 pixels. One pixel is described by a 16-bit word. The value range used is 0...16383.

There are five accessible video signals:

- Raw signal
- Dark corrected signal
- Light corrected signal

You can query the dark value table and the light value table with the commands DARKCORR_PRINT and LIGHTCORR_PRINT.

Pixel 0	Pixel 1	..	Pixel 511
Raw signal, 16 bit	Raw signal	..	Raw signal
Dark corrected signal, 16 Bit	Dark corrected signal	..	Dark corrected signal
Light corrected signal, 16 Bit	Light corrected signal	..	Light corrected signal

Fig. 129 Data structure of the video signals

A 5.4.3 Exposure Time

The output of the exposure time via the RS422 interface is done with a resolution of 100 ns. The data word is 18 bits wide.

A 5.4.4 Encoder

The encoder values for transmission can be selected individually. Only the lower 18 bits of the encoder values are transmitted when transmitting via RS422.

A 5.4.5 Measured Value Counter

Only the lower 18 bits of the profile counter are transmitted on the RS422 interface.

A 5.4.6 Timestamp

The system-internal resolution of the time stamp is 1 μ s. When transmitting via RS422, two 18-bit data words are provided (TIMESTAMP_LOW and TIMESTAMP_HIGH).

A 5.4.7 Measuring Data (Distances and Intensities)

One intensity (if selected) and one measured value are transmitted for each selected distance.

Bit position	Description
0 - 10	Intensity of the peak (100 % corresponds to 1024)

Fig. 130 Intensity table

When transmitting via RS422, Intensity of the peak is transmitted with 10 bits.

The intensity value is determined based on the calculation rule below:

$$\text{Intensität} = \frac{\text{Max_dark}}{\text{Sättigung} - \text{Max_raw} + \text{Max_dark}}$$

- Max_dark refers to the dark corrected signal.
- Max_raw refers to the raw signal.
- Saturation refers to the AD range ($2^{14}-1$).

Details for the format for RS422 can also be found in the Measurement Data Formats section, see [Chap. A 5.5.1](#).

A 5.4.8 Trigger Time Difference

The trigger time difference is output via RS422 as an 18-bit unsigned integer with a resolution of 100 ns.

Value range 0...100000

A 5.4.9 Differences (thicknesses)

Calculated differences between two distances have the same format as the distances.

The selected differences between distance 1 and the other distances are output first, then those of distance 2, ...

Details for the format for RS422 can also be found in the Measurement Data Formats section, see [Chap. A 5.5.1](#).

A 5.4.10 Statistical Values

The statistical values have the same format as the distances.

Minimum is transmitted first (if selected), then maximum and finally peak-to-peak.

A 5.4.11 Peak Symmetry

The peak symmetry value is output via RS422 as 18 bit (signed integer) with 4 bit decimal places.

A 5.5 Measuring Data Formats

A 5.5.1 Data Format RS422 Interface

A 5.5.1.1 Video Data

<Preamble>	<Size>	<video data>	<End>
Start identifier 64 bit 0xFFFF00FFFF000000	Size 32 Bit Volume of the video data in bytes	16 Bit unsigned	End identifier 32 bit 0xFEFE0000

Fig. 131 Structure of a video frame

Data structure, see Fig. 129.

A 5.5.1.2 Measured Values

The output of distance measured values and other measured values via RS422 requires subsequent conversion into the relevant unit. The measurement data, if requested, always follows a video frame.

Output value 1:

	Preamble		Data bits					
L-Byte	0	0	D5	D4	D3	D2	D1	D0
M-Byte	0	1	D11	D10	D9	D8	D7	D6
H-Byte	1	0	D17	D16	D15	D14	D13	D12

Output value 2 .. 32:

	Preamble		Data bits					
L-Byte	0	0	D5	D4	D3	D2	D1	D0
M-Byte	0	1	D11	D10	D9	D8	D7	D6
H-Byte	1	1	D17	D16	D15	D14	D13	D12

Value range for the distance and thickness measurement:

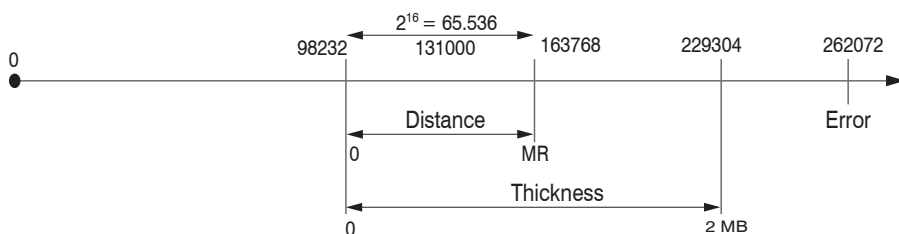

131000 = mid of measuring range for the distance measurement

MB = measuring range

The linearized measured values can be converted into millimeters according to the following formula:

$$x = \frac{(d_{\text{OUT}} - 98232) * MR}{65536}$$

x = distance / thickness in mm

d_{OUT} = digital output value

MR = measuring range in mm

All values greater than 262072 are error values and are defined as follows:

Error code	Description
262073	Scaling error RS422 interface underflow
262074	Scaling error RS422 interface overflow
262075	Data volume too large for baud rate selected ¹
262076	No peak is present.
262077	Peak is before the measuring range (MB)
262078	Peak is behind the measuring range (MB)
262079	Measured value cannot be calculated

For all other data outputs except the measured value data, the limitations are defined in the relevant sections.

1) This error occurs when more data is to be output than can be transmitted at the selected baud rate at the selected measuring frequency. There are the following options of rectifying this error:

- Increase baud rate, see [Chap. A 5.3.7](#)
- Decrease measuring frequency, see [Chap. A 5.3.9.5](#)
- Reduce data volume; if 2 data words were selected, reduce to one data word, see [Chap. A 5.3.13](#)
- Reduce output data rate, see [Chap. A 5.3.12.2](#)

A 5.6 Warning and Error Messages

E200 I/O operation failed

E202 Access denied

E204 Received unsupported character

E205 Unexpected quotation mark

E210 Unknown command

E212 Command not available in current context

E214 Entered command is too long to be processed

E230 Unknown parameter

E231 Empty parameters are not allowed

E232 Wrong parameter count

E233 Command has too many parameters

E234 Wrong or unknown parameter type

E236 Value is out of range or the format is invalid

E262 Active signal transfer, please stop before

E270 No signals selected

E272 Invalid combination of signal parameters, please check measure mode and signal selection

E276 Given signal is not selected for output

E277 One or more values were unavailable. Please check output signal selection

E281 Not enough memory available

E282 Unknown output signal

E283 Output signal is unavailable with the current configuration

E284 No configuration entry was found for the given signal

E285 Name is too long

E286 Names must begin with an alphabetic character, and be 2 to 15 characters long. Permitted characters are: a-zA-Z0-9_

E320 Wrong info-data of the update

E321 Update file is too large

E322 Error during data transmission of the update

E323 Timeout during the update

E324 File is not valid for this sensor

E325 Invalid file type

E327 Invalid checksum

E331 Validation of import file failed

E332 Error during import

E333 No overwrite during import allowed

E340 Too many output values for RS422 selected

E350 The new passwords are not identical

E351 No password given

E360 Name already exists or not allowed

E361 Name begins or ends with spaces or is empty

E362 Storage region is full

E363 Setting name not found

E364 Setting is invalid

E500 Material table is empty

E502 Material table is full

E504 Material name not found

E600 ROI begin must be less than ROI end

E602 Master value is out of range

E603 One or more values were out of range

E610 Encoder: minimum is greater than maximum

E611 Encoder's start value must be less than the maximum value

E615 Synchronization as slave and triggering at level or edge are not possible at the same time

E616 Software triggering is not active

E618 Sensor head not available

E621 The entry already exists

E622 The requested dataset/table doesn't exist.

E623 Not available in EtherCAT mode

E624 Not allowed when EtherCAT SYNC0 synchronization is active

W505 Refractivity correction deactivated, vacuum is used as material

W526 Output signal selection modified by the system

W528 The shutter time has been changed to match the measurement rate and the system requirements.

W530 The IP settings has been changed.

A 6 Switch between EtherCAT and Ethernet Setup Mode

The IFD241x starts with the last saved operating mode. Factory setting is EtherCAT. Access via Ethernet is possible in Ethernet setup mode.

➤ Press the **Correct** key on the IFD2410/2415 or **Multifunction** on the IFC2411 and hold it, before you switch on the power supply. Release the key as soon as the **Intensity LED** flashes yellow. Press the key again for approx. 10 to 15 seconds until the **Intensity LED** flashes red.

The red flashing starts at 8 Hz after 10 seconds within the time $t_2 \dots t_3$. Release the key again after 15 seconds at the latest. Upon releasing the **Correct** or **Multifunction** key, the **Intensity LED** will start flashing yellow at 8 Hz by the time point t_3 at the latest.

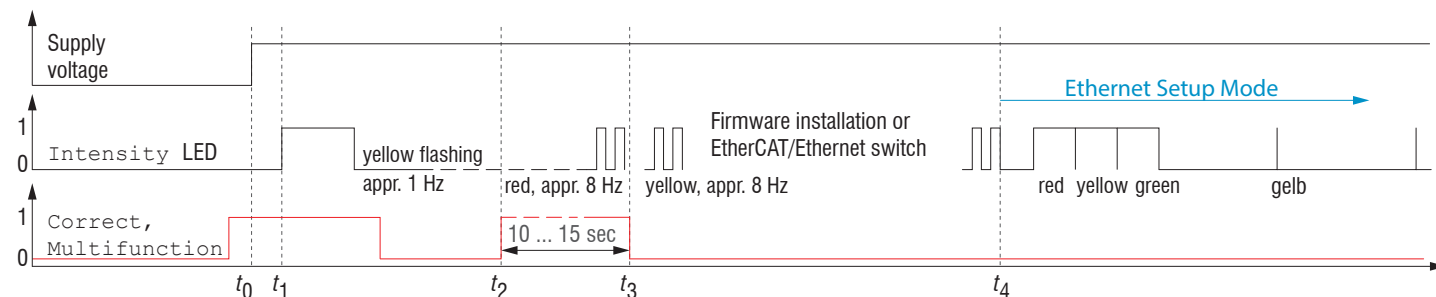

Fig. 132 Flowchart for starting an IFx241x in Ethernet setup mode

After the firmware has been installed or changed, the IFD241x restarts itself at the timepoint t_4 .

t_0 : Supply voltage is applied

t_1 : The **Intensity LED** starts flashing yellow, the key can be released

t_2 : Within 15 sec. ($t_2 - t_1$), push the key again and hold for another 10 ... 15 sec. ($t_3 - t_2$)

$t_3 \dots t_4$: The change from EtherCAT to Ethernet setup mode begins, max. duration 1 min.

t_4 : The IFD241x starts in Ethernet setup mode, the **Intensity LED** lights up briefly at intervals of approx. 1 sec.

A 7 Switching between Ethernet Setup Mode and EtherCAT

The IFD241x starts with the last saved operating mode. You can switch the sensor to EtherCAT mode with the **Correct** or **Multifunction** key.

➤ Press the **Correct** key on the IFD2410/2415 or **Multifunction** on the IFC2411 and hold it, before you switch on the power supply. Release the key as soon as the **Intensity LED** flashes yellow. Press the key again for approx. 10 to 15 seconds until the **Intensity LED** flashes red.

The red flashing starts at 8 Hz after 10 seconds within the time $t_2 \dots t_3$. Release the key again after 15 seconds at the latest. Upon releasing the **Correct** or **Multifunction** key, the **Intensity LED** will start flashing yellow at 8 Hz by the time point t_3 at the latest.

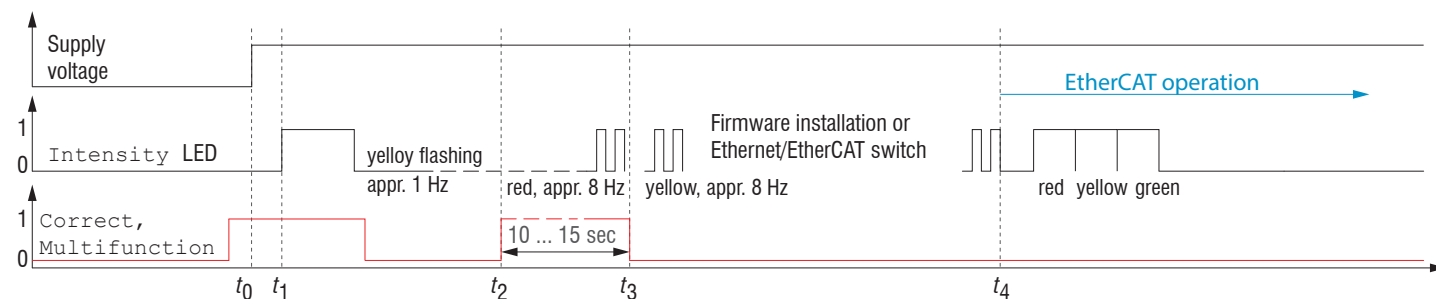

Fig. 133 Flowchart for starting an IFx241x in EtherCAT mode

After the firmware has been installed or changed, the sensor restarts itself at the timepoint t_4 .

t_0 : Supply voltage is applied

t_1 : The **Intensity LED** starts flashing yellow, the key can be released

t_2 : Within 15 sec. ($t_2 - t_1$), push the key again and hold for another 10 ... 15 sec. ($t_3 - t_2$)

$t_3 \dots t_4$: The change from Ethernet setup mode to EtherCAT begins, max. duration 1 min.

t_4 : The IFD241x starts in EtherCAT operating mode.

A 8 Telnet

A 8.1 General

The Telnet service allows you to communicate with the IFD241x from your PC. To communicate with Telnet, you will need

- a connection between the IFD241x and your PC,
 - Ethernet Setup Mode
 - RS442 communication
 - Ethernet over EtherCAT (EoE)
- the ASCII commands, see [Chap. A 5](#).

A 8.2 Establishing the Connection

➤ Start the program `Telnet.exe` via `Start > Run`.

➤ Type in the command `o 192.254.168.150` or the IP address of the controller.

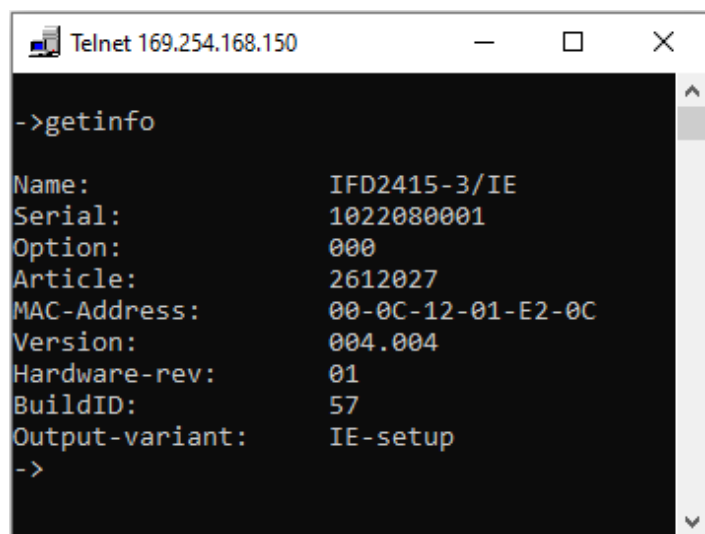

```

Telnet 169.254.168.150
->getinfo
Name:                IFD2415-3/IE
Serial:              1022080001
Option:              000
Article:             2612027
MAC-Address:         00-0C-12-01-E2-0C
Version:             004.004
Hardware-rev:        01
BuildID:             57
Output-variant:      IE-setup
->
  
```

Fig. 134 Telnet start screen of IFD241x

A command always consists of the command name and zero or several parameters that are separated with a space. The currently set parameter value is reset if a command is invoked without parameters.

The output format is:

```
<Command name> <Parameter1> [<Parameter2> [...]]
```

The returned command can be used again without changes for setting the password. After a command is processed, a line break and a prompt (“->”) is always returned. In the event of an error, an error message beginning with `Exx`, where `xx` stands for a unique error number, comes before the prompt.

- **i** If no connection is successfully established after the IP address is sent, send a `c` to close the connection. Now send the command `o 192.254.168.150` again to establish the connection.

A 8.3 Help on a Command

Telnet can output information about a command. For this, enter the sequence “HELP <command name>”.

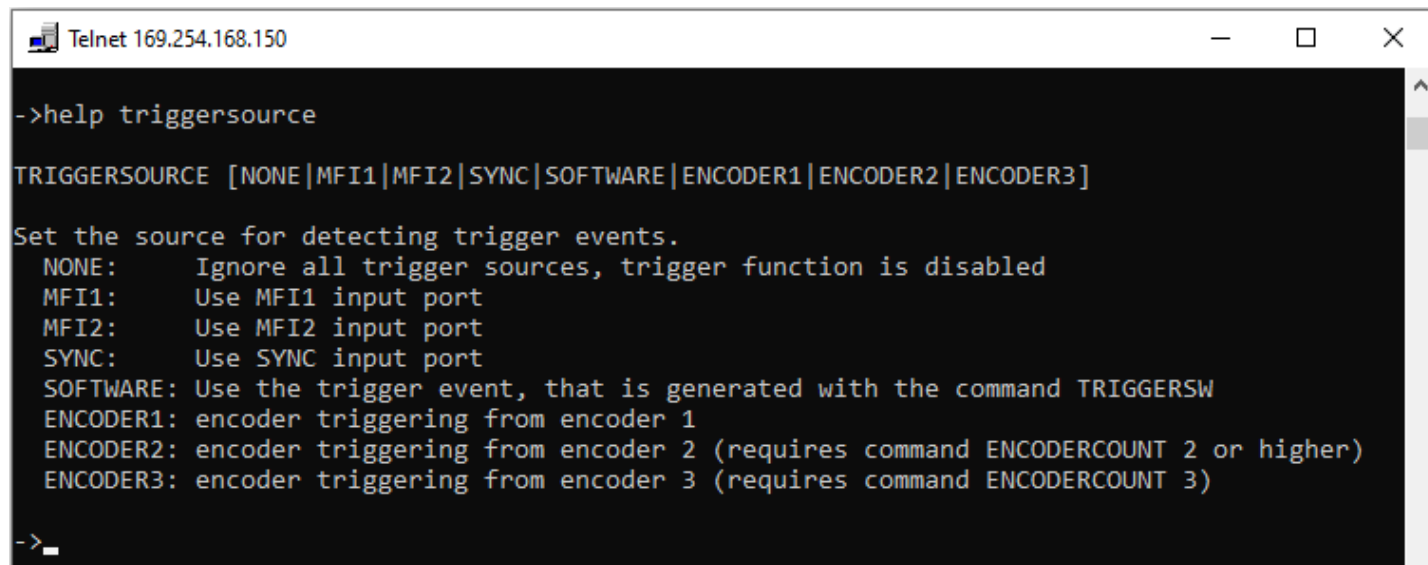
A screenshot of a Telnet window titled "Telnet 169.254.168.150". The window shows a terminal session where the user has entered the command "help triggersource". The output displays the command's syntax: "TRIGGERSOURCE [NONE|MFI1|MFI2|SYNC|SOFTWARE|ENCODER1|ENCODER2|ENCODER3]". Below this, it states "Set the source for detecting trigger events." and lists the options: NONE (Ignore all trigger sources), MFI1 (Use MFI1 input port), MFI2 (Use MFI2 input port), SYNC (Use SYNC input port), SOFTWARE (Use the trigger event generated with TRIGGERSW), ENCODER1 (encoder triggering from encoder 1), ENCODER2 (encoder triggering from encoder 2, requires ENCODERCOUNT 2 or higher), and ENCODER3 (encoder triggering from encoder 3, requires ENCODERCOUNT 3). The prompt "->" is visible at the bottom left of the terminal area.

```
->help triggersource
TRIGGERSOURCE [NONE|MFI1|MFI2|SYNC|SOFTWARE|ENCODER1|ENCODER2|ENCODER3]
Set the source for detecting trigger events.
NONE:      Ignore all trigger sources, trigger function is disabled
MFI1:      Use MFI1 input port
MFI2:      Use MFI2 input port
SYNC:      Use SYNC input port
SOFTWARE:  Use the trigger event, that is generated with the command TRIGGERSW
ENCODER1:  encoder triggering from encoder 1
ENCODER2:  encoder triggering from encoder 2 (requires command ENCODERCOUNT 2 or higher)
ENCODER3:  encoder triggering from encoder 3 (requires command ENCODERCOUNT 3)
->
```

Fig. 135 Access the information about the TRIGGERSOURCE command

A 8.4 Error Messages

The following error messages may appear:

- E01 Unknown command: An unknown parameter ID was submitted.
- E06 Access denied: This parameter cannot be accessed at the present time. The controller may not be in Professional mode or the parameter may not be visible due to other settings.
- E08 Unknown parameter: Not enough parameters were submitted.
- E11 The input value is outside the validity range, or the format is invalid: The submitted value is outside the validity range.

The text in the error messages depends on the set language. The error message identifier (Exx) is the same for every language.



MICRO-EPSILON MESSTECHNIK GmbH & Co. KG
Königbacher Str. 15 · 94496 Ortenburg/Germany
Tel. +49 (0) 8542 / 168-0 · Fax +49 (0) 8542 / 168-90
info@micro-epsilon.com · www.micro-epsilon.com
Your local contact: www.micro-epsilon.com/contact/worldwide/

X9751458-A012103MSC
© MICRO-EPSILON MESSTECHNIK